

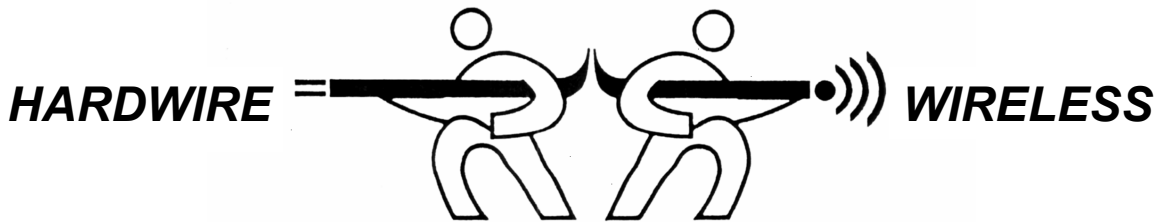

Publicly traded on NASDAQ Symbol: NSSC

# INSTALLATION INSTRUCTIONS



## GEMINI™

# GEM-P1664 CONTROL PANEL/COMMUNICATOR

For use with "Classic" keypads (GEM-RP1CAe2, GEM-RP2ASe2, GEM-RP3DGTL and GEM-RP4RFC/GEM-RP4C) and with "K Series" keypads (GEM-K1CA, GEM-K2AS, GEM-K3DGTL, and GEM-K4RF/GEM-K4)

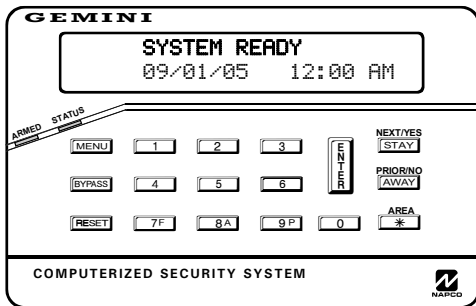

"K Series" GEM-K1CA

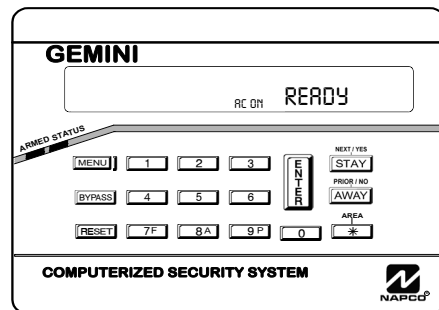

"K Series" GEM-K2AS

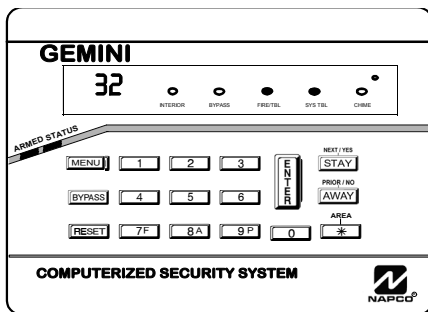

"K Series" GEM-K3DGTL

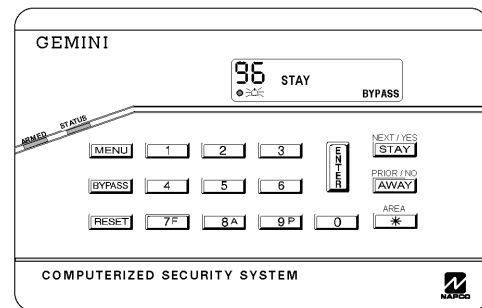

"K Series" GEM-K4RF

**THIS MANUAL INCLUDES FEATURES WHICH ARE ONLY AVAILABLE IN  
GEM-P1664 CONTROL PANEL FIRMWARE VERSION 1.0 OR LATER.**

**IMPORTANT NOTICE**

GEM-P1664 panel version 01 requires the use of the following version keypads:

- GEM-RP1CAe2 Version 9A, GEM-K1CA Version 9A
- GEM-RP2ASe2, Version 7, GEM-K2AS, Version 7
- GEM-RP3DGTL, Version 3, GEM-K3DGTL, Version 3
- GEM-RP4RF, Version 2, GEM-K4/K4RF, Version 2

Upon entering program mode, the keypad display will flash the control panel firmware version, followed by the keypad firmware version:

GEM-RP1CAe2: [019A], GEM-RP2ASe2: [0107], GEM-RP3DGTL: [0103], GEM-RP4RF: [0102]  
GEM-K1CA: [019A], GEM-K2AS: [0107], GEM-K3DGTL: [0103], GEM-K4/K4RF: [0102]

**☞ For consistency, it is recommended that all keypads either be all "classic" (such as the GEM-RP1CAe2 keypad) or all "K Series" (such as the GEM-K1CA)--both keypad types should not be used in one alarm system.**

**CHANGES FROM PREVIOUS EDITION**

The following changes have been made to this manual (WI1424A) since the previous edition (WI1424):

Page 6: Specifications: Current ratings updated.  
Page 59: Wiring Diagram updated.

Refer to accompanying GEM-P1664 Programming Instructions (WI1422 and WI1423) for programming information.



**NAPCO Security Systems, Inc.**  
333 Bayview Avenue, Amityville, New York 11701  
For Sales and Repairs, call toll free: (800) 645-9445  
For direct line to Technical Service, call toll free: (800) 645-9440  
Internet: <http://www.napcosecurity.com>

# TABLE OF CONTENTS

**INTRODUCTION**..... 4

*General Description* ..... 4

*Features*..... 4

*Specifications*..... 6

*Ordering Information* ..... 7

*Summary of UL Requirements* ..... 8

**INSTALLATION**..... 9

*Mounting* ..... 9

*Wiring*..... 10

*Wireless Systems*..... 10

*Typical Residential Fire Installation* ..... 10

*Typical Partitioned Installation*..... 10

**TESTING THE SYSTEM**..... 11

**WIRING CONNECTIONS** ..... 12

*Battery* ..... 12

*Transformer* ..... 12

*Siren/Bell Output*..... 12

*Auxiliary Power* ..... 12

*PGM Outputs* ..... 12

*Remote Bus* ..... 13

*Earth Ground* ..... 13

*Zone Configuration Styles* ..... 14

*Basic Zone Configuration*..... 14

*EZ Zone Doubling Configuration*..... 14

*Zone Expansion Device Compatibility* ..... 15

*4-Wire Smoke Detectors* ..... 15

*2-Wire Smoke Detectors* ..... 15

*Telephone Lines*..... 16

**KEYPAD CONFIGURATION MODE**..... 17

*Keypad Installation*..... 17

*Configuring the Keypads*..... 17

**BASIC OPERATION** .....20

*User Codes & Zone Descriptions* ..... 20

*Arming and Disarming the System*..... 21

*Bypassing Zones* ..... 23

*Unbypassing Zones* ..... 23

*Alarm Indication* ..... 23

*Function Mode/Dealer Program Mode* ..... 23

**KEYPAD MESSAGES**.....26

**GLOSSARY** .....27

**STANDBY-BATTERY CALCULATION WORKSHEET** .....46

**WIRING LEGEND** .....47

**KEYPAD PROGRAMMING MODES** .....48

*Function Mode*..... 48

*Dealer Mode* ..... 49

*Easy Menu Mode*..... 50

*User Mode* ..... 51

*Keypad Configuration Mode*..... 52

**CP-01 QUICK REFERENCE CHART** .....53

**FACTORY DEFAULT DESCRIPTION**.....55

**FCC STATEMENT** .....57

**GEM-P1664 WIRING DIAGRAM** .....59

**LIMITED WARRANTY**.....60



# INTRODUCTION

## GENERAL DESCRIPTION

Napco's Gemini GEM-P1664 is a state-of-the-art microcomputer-based burglary and residential fire alarm control panel of modular design. Integrally an 8-zone panel, it will support up to 64 zones with the use of zone doubling, optional zone expansion modules, wireless receiver modules and/or GEM-RP1CAe2/GEM-K1CA Keypads. Each panel includes an integral digital communicator.

The control panel features programmable area partitioning. That is, the system may be divided into up to 4 discrete multiple-zone areas, each allowing access by only those users programmed for their respective area.

Opening Suppression and Closing Suppression, available through Napco Quickloader software, suppress reporting within programmed "windows". Conversely, Exception Reporting can transmit a "fail to close" if the panel is not armed within programmed intervals and, similarly, a "fail to open" if the panel is not disarmed within programmed intervals. Furthermore, the panel can be programmed to automatically arm either area at any time. A log containing up to 400 events (accessible through Quickloader™ software) monitors control-panel activity referenced to a precision real-time clock. A detailed event history may be displayed at the computer, using Napco's PCD-Windows Quickloader Software.

Keypads feature a liquid-crystal display for messages. In normal use, the LCD shows zone identification and status messages, and the log can also be viewed. Conventional LEDs and a sounder are also provided for annunciation.

Data may be quickly and easily downloaded to the control panel using a PC-compatible computer with Napco's PCD-Windows Quickloader software and PCI2000 computer interface. Or, the panel may be programmed using the keypad in its secondary mode of operation. In the keypad programming modes (there are two: Dealer and User), the LCD shows memory address, data values, programming prompts, and the alphanumeric characters required for entering up to 64 user codes and custom zone descriptions.

**NOTE:** Failure to install and program as described in this manual for UL-listed systems voids the listing mark of Underwriters Laboratories, Inc.

## FEATURES

### Control Panel Features

- ✓ Eight end-of-line-resistor burglary zones programmable for Area (expandable to sixteen end-of-line resistors with zone doubling or series zone doubling with loop supervision), Exit/Entry Delay, Interior (Stay) Bypass, Exit/Entry Follower, Day Zone, Chime, Fire options, Swinger Shutdown, Zone Anding and a variety of other features.
- ✓ Supports up to 64 zones with optional zone-expansion modules, wireless receiver modules and 4-zone keypads.
- ✓ Supports up to 64 individually coded users.
- ✓ Supports three outputs (Bell, PGM1 and PGM2) and up to 16 external outputs (using Relay Module RB3008, RM3008 or the GEM-OUT8. See **Relay Control** in glossary for more information).
- ✓ Supports three keypad panics: Fire, Police & Auxiliary.
- ✓ Supports four independent area partitions.
- ✓ Supports up to seven separate access stations (keypads) by up to 64 users.
- ✓ Supports up to 16 separately-addressable X-10 devices with the GEM-X10 KIT and PC04 interfaces.
- ✓ English-language prompts & system status messages.
- ✓ User Codes and Zone Descriptions outside assigned areas are able to be blocked from keypad display.
- ✓ User-customized zone descriptions, re-programmable as required.
- ✓ Supports 2-wire and 4-wire smoke detectors.
- ✓ Reports alarms, restores and troubles by zone.
- ✓ 400 Event Log.
- ✓ Two programmable entry delay times.
- ✓ One Interior Zone Group.
- ✓ Dynamic battery test interrupts charging and places battery under load every four hours.
- ✓ Two Chimes by zone; programmable duration.
- ✓ Quickloader programmable.
- ✓ 2 PGM outputs.
- ✓ Supports Gemini Wireless Devices.



### Communicator Features

- ✓ Compatible with all major receiver formats, including 4/2, SIA and Point ID (except Radionics Modem II).
- ✓ Rotary dial and TouchTone™ with Rotary backup.
- ✓ Three 20-digit telephone numbers.
- ✓ Backup Reporting; Double Reporting; Split Reporting.
- ✓ 64 User Codes with Opening/Closing -Reporting by user.
- ✓ AC Failure Reporting with programmable report delay.
- ✓ Supervised telephone line with a fixed 60 second delay.
- ✓ Pager capability.

### Keypad Features

- ✓ English-language LCD display; LED and sounder annunciators.
- ✓ Supports up to seven 4-wire keypads.
- ✓ Provisions for fire, police and auxiliary panic alarms.
- ✓ Integral 4-zone EZM included in each keypad (GEM-RP1CAe2/GEM-K1CA only).
- ✓ Fault-Find diagnostics simplify troubleshooting.

### SIA CP-01 Features.







- ✓ See page 59 for complete information regarding how the Factory Program complies with the Security Industry Association False Alarm Reduction Control Panel-01 Standard (SIA FAR CP-01).

### IMPORTANT NOTE

This manual supports the keypad programming of the GEM-P1664 control panel with the NAPCO "classic" GEM-RP1CAe2, GEM-RP2ASe2, and GEM-RP3DGTL keypads as well as the GEM-K1CA, GEM-K2AS, and GEM-K3DGTL "K Series" keypads. The new "K Series" models offer the new STAY and AWAY buttons with simplified functionality, along with the new MENU and ENTER buttons.

While the instructions in this manual are depicted using the GEM-K1CA and GEM-K2AS keypads, the manual applies to both the "classic" and the "K Series" keypads.

**Program Mode** is the same for both keypads--**only the button names have changed**, as follows:

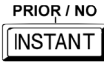
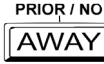
- The  button and the  button operate identically (in Program Mode) for both keypads.
- The  button and the  button operate identically (in Program Mode) for both keypads.
- The  button and the  button operate identically (in Program Mode) for both keypads. The words "NEXT/YES button" are used in this manual.
- The  button and the  button operate identically (in Program Mode) for both keypads. The words "PRIOR/NO button" are used in this manual.

## SPECIFICATIONS

GEM-P1664

Operating Temperature: 0-49°C (32-120°F)

Input Power: 16.5-18.0 VAC via CLASS 2 Plug-In 20VA, 40VA or 50VA Transformer

Loop Voltage: 10-13Vdc

Loop Current: 3mA without Zone Doubling, 2.4mA with Zone Doubling using a 2.2K Ohm end-of-line resistor (Model EOL2.2K); 5mA for 2-wire smoke-detector zones; 1.4 mA using a 3.9K Ohm resistor (Model EOL3.9K) with Zone Doubling; 3mA with Series Zone with Loop Supervision and 3mA with Series Zone Doubling with Loop Supervision

Loop Resistance: 300 Ohm max.; 50 Ohm for 2-wire smoke-detector zones

Alarm Voltage Output: 1

Programmable Negative Outputs: 2

Auxiliary Power Output: 11.7-12.5 VDC

Remote Power Output: 12 VDC regulated (for keypads)

Combined Standby Current (Remote Power + Aux. Power + Fire Power): See following charts.

RESIDENTIAL BURGLARY & COMMERCIAL BURGLARY**				
16.5VAC TRANSFORMER	BATTERY (12 VDC)	STANDBY CURRENT	ALARM CURRENT	STANDBY TIME
40VA/50VA	7 AH	550 mA	550 mA <sup>(1)</sup>	4 Hours
20VA*	7 AH	500 mA	2.0 A	4 Hours
20VA*	7 AH	500 mA	2.0 A	6 Hours

COMBINATION RESIDENTIAL FIRE & RESIDENTIAL BURGLARY				
16.5VAC TRANSFORMER	BATTERY (12 VDC)	STANDBY CURRENT	ALARM CURRENT	STANDBY TIME
40VA/50VA	7 AH	120 mA	520 mA <sup>(1)</sup>	24 Hours
40VA/50VA *	Two 7 AH	360 mA	280 mA <sup>(1)</sup>	24 Hours
20VA *	7 AH	120 mA	360 mA <sup>(1)</sup>	24 Hours
20VA *	Two 7 AH	360 mA	120 mA <sup>(1)</sup>	24 Hours

NOTE: <sup>(1)</sup> Alarm current can be increased by reducing standby current by the same amount.

\* Not evaluated by UL.

\*\* Commercial Burglary specifications not evaluated by UL.

## FOR ALL UL INSTALLATIONS

### "ENABLE RESIDENTIAL FIRE" (ADDRESS 1422) MUST BE PROGRAMMED

The feature "Enable Residential Fire" (address 1422, option 4 / bit 3) must be programmed for ALL UL installations. To program, please refer to the GEM-P1664 Programming Instructions (WI1422 and WI1423) for further information.

**EZM Module:** GEM-EZM816: Input, 50mA

**Keypad Current:** GEM-RP1CAe2: 100mA; 35mA if back lighting is disabled (cut W1, W2 & W3).  
PGM Output: 5mA, 12V Special Application

**Maximum Number of Keypads:** 7

**Maximum Wiring Length for each run (#22AWG):** 1000' divided by total number of keypads and EZMs on run

**Keypad Dimensions:** 4" x 5" x 1" (HWD); 11.1cm x 14.9cm x 2.7cm (HWD)



## ORDERING INFORMATION

### System Components

- GEM-P1664:** Residential UL-Listed Burg and Fire Control Panel.
- GEM-RP1CAe2:** 32-Character LCD Burg & Fire Keypad with 4 EOL Zones.
- GEM-RP2ASe2:** LCD Burg & Fire Keypad with remote panic.
- GEM-RP3DGTL:** Burg & Fire Keypad.
- GEM-RP4RFC:** Digital Icon Burg & Fire Keypad with Integral RF Receiver.
- GEM-RP4C:** Digital Icon Burg & Fire Keypad.
- GEM-K1CA:** 32-Character LCD Burg & Fire Keypad with 4 EOL Zones.
- GEM-K2AS:** LCD Burg & Fire Keypad with remote panic.
- GEM-K3DGTL:** Burg & Fire Keypad.
- GEM-K4RF:** Digital Icon Burg & Fire Keypad with Integral RF Receiver.
- GEM-K4:** Digital Icon Burg & Fire Keypad.

### Optional Accessories and Peripherals

- GEM-EZM8:** 8 Zone Expansion Zone Module
- GEM-EZM816:** 4-16 Zone Expansion Zone Module
- GEM-EVA 1:** Electronic Voice Annunciator
- GEM-RECV8:** Wireless Receiver, 8 Zones
- GEM-RECV16:** Wireless Receiver, 32 Zones
- GEM-RECV96:** Wireless Receiver, 64 Zones
- GEM-TRANS2:** Window/Door Transmitter, 2-Point
- GEM-RTRANS:** Recessed Window/Door Transmitter
- GEM-KEYF:** Key Fob Transmitter
- GEM-SMK:** Wireless Smoke Detector
- GEM-PIR:** Wireless PIR
- GEM-PIRPET:** Wireless Pet Immune Transmitter\*
- GEM-RS232:** Isolated Computer Interface
- GEM-DT:** Wireless Dual-Technology Sensor
- GEM-GB:** Wireless Glass-Break Detector\*
- GEM-X10KIT:** X-10 Interface\*
- GEM-OUT8:** 8 output active low output module
- GEM-TEMP64:** GEM-P1664 indoor/outdoor programmable temperature sensor\*
- RM3008:** Relay Module (in enclosure)
- M278:** Line-Reversal Module
- PS3002:** Power-Supply Module, 13.2Vdc, 1.9A\*
- EOL2.2K:** End-of-Line Resistor Assy., 2.2k Ohm
- EOL3.9K:** End-of-Line Resistor Assy., 3.9k Ohm for Zone Doubling
- EOL4.7K:** End-of-Line Resistor Assy., 4.7k Ohm
- FT2200:** End-of-Line Relay/Resistor Supervisory Module
- RB1000:** Relay Board, single output\*
- RBATH1:** Dual Battery Harness
- RPB-3:** Universal Keypad Mounting Box
- TRF11:** Transformer, 16.5Vac/40VA, Class 2
- TRF14:** Transformer, 16.5Vac/50VA, Class 2
- WL1:** Wire Assembly with Lug Connector, 20"

- VERI-PHONE:** Two-Way Voice/Listen-In Module
- PCD-Windows:** Downloading Software (for Windows) for IBM PC-Compatible, V5.0 or greater
- PCI2000/3000:** Software Interface for IBM PC-Compatible Computer\*
- PCI-MINI:** Notebook Computer Interface\*
- W834-1:** Keypad Cable, plug-in (20")
- OI193:** User Guide, GEM-RP1CAe2
- OI192:** User Guide, GEM-RP2ASe2
- OI249:** User Guide, GEM-RP3DGTL
- OI278:** User Guide, GEM-RP4C & RP4RFC
- WI1212:** Installation Manual, GEM-RP4C
- WI1128:** Installation Manual, GEM-RP4RFC
- OI279:** User Guide, GEM-K1CA
- OI280:** User Guide, GEM-K2AS
- OI281:** User Guide, GEM-K3DGTL
- OI283:** User Guide, GEM-K4 & K4RF
- WI1178:** Installation Manual, GEM-K4
- WI1179:** Installation Manual, GEM-K4RF

- WI1422:** GEM-P1664 Programming Instructions (using GEM-RP1CAe2 / GEM-K1CA keypads).
- WI1423:** GEM-P1664 Programming Instructions (using GEM-RP2ASe2 / GEM-K2AS or GEM-RP3DGTL / GEM-K3DGTL keypads).
- WI1424:** GEM-P1664 Installation Instructions
- WIZARD IIe:** Telephone Interface Module\*

\*Not Investigated by UL

### UL Listings

Household Burglar Alarm System Units: UL1023  
Household Fire Warning System Units: UL985  
Security Industry Association (SIA) False Alarm Reduction Standard CP-01

\*\* Pending

### Napco Group Europe Ltd.

Libra Wireless Transmitters and Receivers for connection to Napco Intruder Control Panels (Operates on 433MHz, European Approved Frequency)

- WI925: LIBRA-RECVXP-433 Wireless 8 Zone Receiver
- WI924: LIBRA-RECV8-433, LIBRA-REC16433, LIBRA-REC96433, Wireless 8/16/96 Zone Receiver
- WI923: LIBRA-TRANS433, Wireless Door Contact
- WI929: LIBRA-PIR433, Wireless PIR
- WI931: LIBRA-KEYF433, Wireless KeyFob
- WI930: LIBRA-SMK433, Wireless Smoke Detector
- WI928: LIBRA-GB433, Wireless Glass Break Sensor



**Smoke Detectors, 4-Wire:**

1. ESL 445AT, 445C, 445CT, 445CR, 445CRT
2. Hochiki America SLG-12 with YBC-RL4-RA Base
3. System Sensor 2312/24T; 1412; 1412TH; 2412TH

*Subtract total smoke-detector alarm current from available standby current.*

**Note:** Any normally-open devices that do not require power from the control panel, such as pull stations and thermostats may be used if acceptable to the Authority having Jurisdiction.

**UL Compatible Smoke Detectors (Providing UL Recognition or Listing)**

Manufacturer	4-Wire Smoke Detector		2-Wire Smoke Detector *		Smoke Detector Base
Napco	FW-4		FW-2		
Sentrol	449AT 449C 449CRT 449CST 449CSRT 449CSRH 449CSST	449CLT 449CSLT 449CTE 741U 742U	712U 722U 732U 711U 721U 721UT	731U	701U 702U 702RE 702RU
System Sensor	1112 2112	2112T 2112TSRB	2100 2100T	1100	

**Note:** \* Voltage Rating: 8.5-13.3 VDC, Maximum Number of Detectors: 10

**SUMMARY OF UL REQUIREMENTS**

**Residential**

- ✓ Recognized Limited-Energy Cable for initiating, indicating and supplementary circuits.
- ✓ Initiating loops supervised if longer than 3 feet
- ✓ FT2200 End-of-Line Relay for Fire (if using 4-wire smoke detectors)
- ✓ Minimum alarm timeout of 5 minutes
- ✓ Maximum exit time: 60 seconds
- ✓ Maximum entry time: 45 seconds
- ✓ Do not program “Swinger Shutdown”, “Force Arming”, “Selective Bypass” or “50 ms Loop Response”
- ✓ “Abort Delay” may not exceed 45 seconds
- ✓ Program “Disable Callback Download”
- ✓ Automatic dialer may not dial a police station number that has not been dedicated for such service
- ✓ System must be tested at least weekly under AC/battery and Battery-Only conditions
- ✓ Replace the rechargeable battery at least every 5 years
- ✓ If the battery is heavily discharged, replace it or have it tested by a qualified technician
- ✓ For silent panic, connect only to UL-listed holdup devices
- ✓ All zones must be programmed for “Priority”
- ✓ Do not program any zones for “Keyswitch Arming”
- ✓ System must be serviced at least once every year
- ✓ Residential Fire and Combination Residential Fire & Burglary must program “Residential Fire”
- ✓ Keypad Expansion (EZM) Zones are not to be used as fire zones
- ✓ Keypad Auxiliary is not to be selected
- ✓ The GEM-K Series Keypads must have the indicators printed on the face label (Fire, Police and Auxiliary) covered by a supplied label if not in use.

Smoke detectors & Summary of UL Requirements



# INSTALLATION

**CAUTION:** This equipment generates and uses radio-frequency energy. If not installed using conventional installation practices for RF devices, it may cause interference to radio and television reception. It has been tested and found to comply with the limits for a Class A computing device pursuant to Subpart B of Part 15 of FCC Rules, which are designed to provide reasonable protection against such interference. However, there is no guarantee that interference will not occur in a particular installation. If it has been found to cause interference to radio or television reception, which can be determined by removing and reapplying AC and battery power to the equipment, the installer should try to correct the interference by one or more of the following measures: reorient the receiving antenna; connect the power transformer to a different outlet so that the control panel and receiver are on different branch circuits; relocate the control panel with respect to the receiver.

## MOUNTING

### Control Panel

Choose a mounting location accessible to (a) a continuously-powered AC source, (b) system ground, a steel or copper ground rod, ideally no further away than 10 feet, and (c) telephone lines (keep telephone wiring away from keypad wires). Remove appropriate knockouts for cables. Place the control panel at a convenient viewing height and mark the mounting holes. Attach the enclosure using screws suitable for the mounting surface.

### Grounding

Connect the control-panel grounding screw to a metal cold-water pipe or a long steel (or copper) ground rod driven deeply into the earth. Do not use a gas pipe, plastic pipe or AC ground connections. Use at least 16-gauge wire. Make the run as short and direct as possible, without any sharp bends in the wire.

### Keypad

A keypad should be located near each exit/entry door. The keypad features a handy pull-up reference label. Before mounting the keypad onto the wall, push the Sliding Label Plate (with label and felt backing affixed and handle facing forward) down the guides at the rear of the keypad until it snaps into place. Once installed, the Sliding Label Plate cannot be removed without first removing the keypad from the wall. Note: (1) The keypad fire and panic keys should not be considered a substitute for a listed manual initiating device, such as a pull box. (2) Each GEM-RP1CAe2 includes provisions for four additional zones. See ADDING EXPANSION ZONES.

If installing onto a double-gang box, insert mounting screws through the two vertical elongated holes on the left side of the case and into the box. If the box is visible when viewed from the front, adjust the keypad vertically and tighten the screws. Then, using hardware suitable for the mounting surface, add one or two screws at the right side of the keypad case directly into the wall to ensure a secure installation. **Note:** Do not overtighten the screws! Uneven walls may cause the keypad case to distort.



## Wiring

Wire keypad(s), zones, expansion zone modules and output devices as shown on the Wiring Diagram. Note that the Wiring Diagram contains important information not available elsewhere in this manual.

**CAUTION:** Do not run telephone wiring near speaker wires; do not run keypad wiring with loop wiring.

### Adding Expansion Zones

GEM-P1664 control panel can support up to 16 zones as is, however this number may be increased to as many as 64 programmable zones using optional expansion zone modules (EZMs).

### Wireless Systems

With the addition of at least one GEM-RECV series receiver, the GEM-P1664 will support up to 64 wireless transmitters. The panel can accommodate one or two receivers within the premises, responding to the one with the stronger transmitter signal. If any transmitters are selected for the default program, a GEM-RECV receiver will automatically be programmed.

The keypad can display the status of any transmitter, indicating the condition of the zone (normal or open) and transmitter troubles (low battery, tamper or supervisory failure), and signal strength of the last transmission. A receiver failure will be indicated by "E06-NN" ("no response", with NN representing the receiver number).

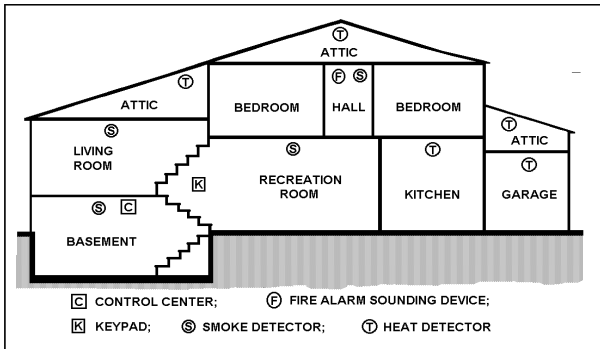

### TYPICAL RESIDENTIAL FIRE INSTALLATION (Where permitted by local codes)

At least one smoke detector should be installed directly outside each sleeping area. If there is more than one floor, additional smoke detectors should be installed on each level, including the basement. The living-area and basement smoke detectors should be installed near the stairway of the next upper level. For increased protection, additional detectors should be installed in areas other than those required, such as the dining room, bedrooms, utility room, furnace room, and hallways. Heat detectors, rather than smoke detectors, are recommended in kitchens, attics, and garages due to conditions that may result in false alarms and improper operation. Large areas and areas with

partitions, ceiling beams, doorways, and open joists will require additional detectors.

Refer to NFPA Standard No. 74 (National Fire Protection Association, Batterymarch Park, Quincy, MA 02269) for additional information, including proper mounting of detectors.

### TYPICAL PARTITIONED INSTALLATION

(4 Partitions Available)

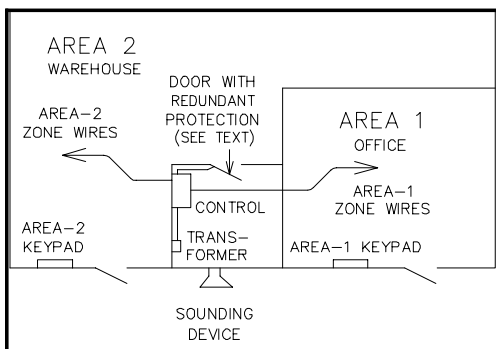

Described and illustrated here are an example of a partitioned system with common-area protection of the control-panel room. This system meets UL requirements for a partitioned system.

All areas must be owned and managed by the same person(s).

All areas must be part of one building at one street address.

The control panel and all wiring protecting each partitioned area must be confined to the respective area and may not impinge upon the other area. This requires that the control panel room have redundant protection; that is (a) multiple sets of door contacts, each wired to a



separate zone and (b) one of those zones programmed for each area. In order to gain access to this protected area without causing an alarm, both partitions must be disarmed. In lieu of redundant protection, 24-Hour Zones may be used. Any zone protecting the control panel and transformer may not be programmed for bypass.

The sounding device must be placed such that the bell test can be heard by all partitions. **Note:** NFPA 74 (Household Fire Warning Equipment) requires that a fire alarm audible device be installed indoors.

The User Program Code is not to be given to anyone except the authority responsible for all partitions.

### TESTING THE SYSTEM



After installation is completed, test the system as follows.

-  1. Call the central station to inform them of the test.
-  2. Initiate an alarm, preferably on a zone that activates a steady siren, and verify proper signalling.
-  3. Call the central station to confirm their receipt of a good transmission.



**Note:** Be sure to test all enabled keypad panics.

### Signal Strength Testing/Wireless Systems

To test the operation of wireless transmitters, proceed as follows.

-  1. Enter the Fault-Find Mode. (See **Dealer Mode** on page 52. Panel must be disarmed).
-  2. Fault a point of the transmitter to be tested by opening the loop. If the signal strength of the transmitter is 3 or greater, the keypad will beep, as follows:

Signal Power	Beeps
0-2	0
3	1
4-5	2
6-7	3
8-10	4

-  3. Restore the wireless point (close the loop).
-  The transmitter signal strength will be displayed on a scale of 3-10 with 3 considered marginal and 10 considered excellent. Note that if the signal strength is less than 3, the keypad will not beep and the strength will not be displayed. Except in the Fault-Find Mode, signal strengths less than 3 will be entered into the system log. Upon zone restore, the keypad will beep once.



# WIRING CONNECTIONS

## BATTERY

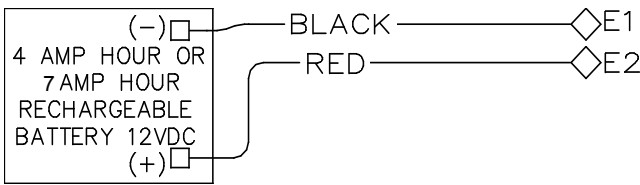

The RED (+) and BLACK (-) flying leads must be connected to a 12VDC 4-7 AH Rechargeable Battery, to serve as backup power in the event of AC Power Failure. **NOTE:** To calculate the available standby time refer to the Standby-Battery Calculation Worksheet at the back of this manual.

## TRANSFORMER

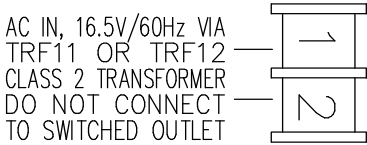

(The following applies to installations in the United States of America): Connect a 16.5 VAC Transformer to Terminals 1 and 2, using a wire of #18 AWG. or larger at a distance of 15 ft. or less from the control panel. **NOTE:** Do not connect to a switched outlet.

## SIREN/BELL POWER

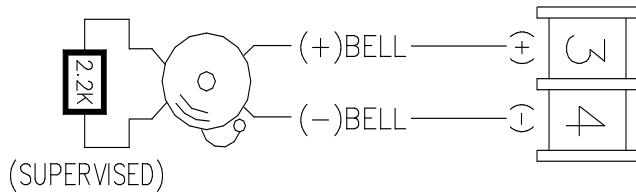

Connect the alarm sounding devices (self-contained sirens, speakers or a mechanical bell) to Terminals 3 and 4. Any self-contained siren requiring a 12 VDC input can be connected. When connecting a mechanical bell, it must be supervised using a 2.2k Ohm resistor. To connect 8 Ohm Speakers use a Siren Driver with the proper polarity observed. **NOTE:** Refer to the GEM-P1664 Wiring Diagram for alarm current specification. **Note:** In NFPA Household Fire Installations, only a single siren or bell can be used on this bell circuit.

## AUXILIARY POWER

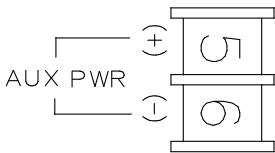

Connect the auxiliary devices (motion detectors, glass breaks, etc.) to Terminals 5 and 6. Auxiliary Power provides 11.7-12.5 VDC nominal output which is used for powering auxiliary devices. **NOTE:** To calculate the available standby time refer to the Standby-Battery Calculation Worksheet at the back of this manual.

## PGM OUTPUTS (PGM1 & PGM2)

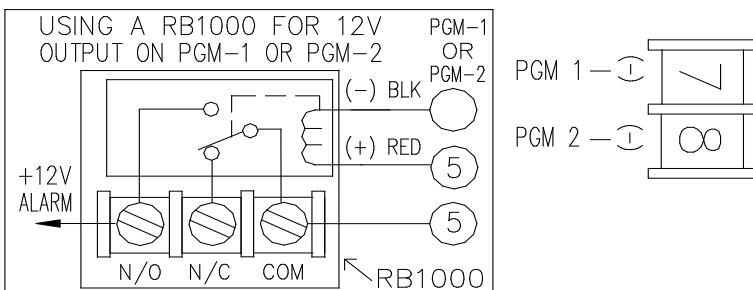

PGM1 and PGM2 are negative switched programmable outputs that can be activated depending on the programming options selected (see GEM-P1664 Programming Instructions). Connect the device controlled by the programmable output between terminal 5 (+) and the PGM output (-), either terminal 7 or 8. As an example, the connection to the RB1000 Relay Module is shown.

# REMOTE BUS

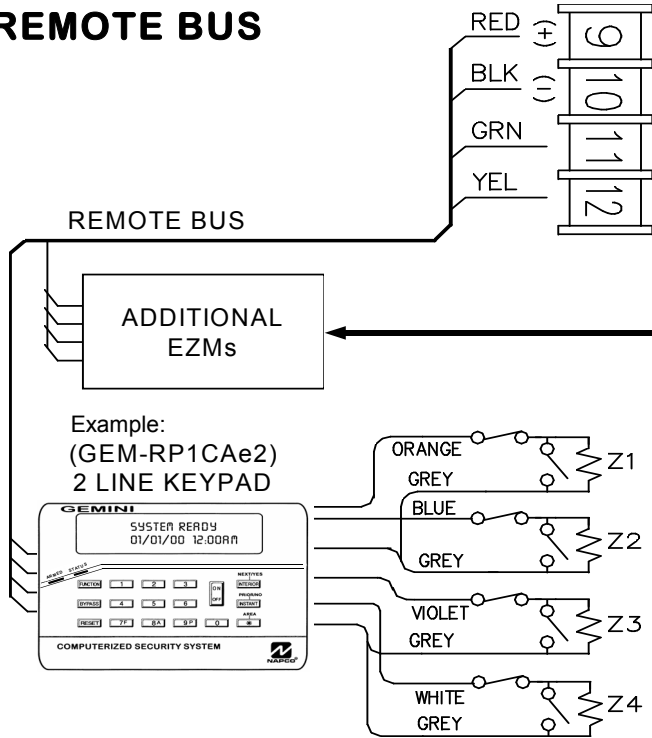

**NOTE:** Refer to the EZM Installation Instructions for specific wiring information.

- AVAILABLE DEVICES**
1. **KEYPADS:** GEM-RP1CAe2, GEM-RP2ASe2, GEM-RP3DGTL, GEM-RP4 series, GEM-K1CA, GEM-K2AS, GEM-K3DGTL, GEM-K4 series, (7 maximum)
  2. **X-10 INTERFACE:** GEM-X10 (16 devices maximum)
  3. **WIRED ZONE EXPANDER:** GEM-EZM4/8EX, GEM-EZM4/8 (64 zones maximum)
  4. **WIRELESS RECEIVERS:** GEM-RECV8, GEM-RECV16, GEM-RECV96 (64 zones maximum)
  5. **RELAY MODULE:** RM3008 (16 relays maximum)
  6. **VOICE INTERFACE:** GEM-EVA 1
  7. **TELEPHONE INTERFACE:** WIZARD IIe

Connect the available devices as shown above to the remote bus terminals (9, 10, 11 & 12). Observe the correct color wire connections. When connecting the keypads, first configure them accordingly (refer to the Keypad Configuration Mode at the back of this manual). Keypads should be located near every exit/entry door. Up to seven keypads may be connected if the longest cable run from the panel, to the farthest keypad (daisy chained or home-run) is less than 1000 feet. The maximum distance for seven keypads is 300 feet using 22 AWG. wire. **NOTE:** When running keypad wire, avoid wiring parallel to other types of wiring.

# EARTH GROUND



**NOTE:** Do not use a gas pipe, plastic pipe or AC ground connections.

Connect the control panel EARTH GROUND screw to a metal cold-water pipe using at least a #16 AWG. wire. Do not use a gas pipe, plastic pipe or AC ground connections. Also, connect the circuit board to the metal enclosure. Connect a wire with a ground lug crimped or soldered onto one end of the EARTH GROUND screw to the cabinet. **NOTE:** Grounding connections should avoid bends in the grounding wire whenever possible.

Wiring Connections: Remote Bus & Earth Ground

## BASIC ZONE CONFIGURATION

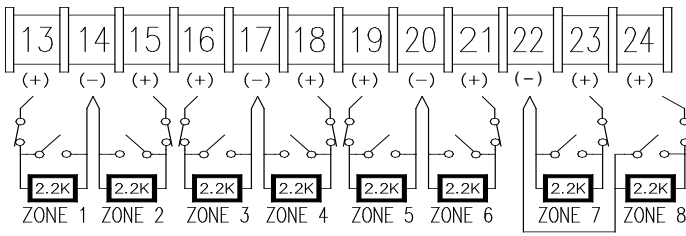

zone modules or wireless sensor transmitters/receivers can be used to obtain zones numbered 9 through 32.

The basic zone configuration for the GEM-P1664 is 8 zones. Connect as shown above to terminals 13-24. Normally Closed (N.C.) devices may be wired in series or Normally Open (N.O.) devices may be wired in parallel. Use the 2.2K Ohm end-of-line (E.O.L.) resistor in each zone, if selected in programming (refer to the GEM-P1664 Programming Instructions). Zones 1-8 can be selected for a "Fast Loop Response (50 ms)" or a "Normal Loop Response (750 ms)". Other zone options include Zone Type (Entry/Exit, Interior, 24 Hour Protection, Trouble and Fire), Instant, Chime, Area Selection and PGM Output selection. Additional expansion

## EZ ZONE DOUBLING™ CONFIGURATION

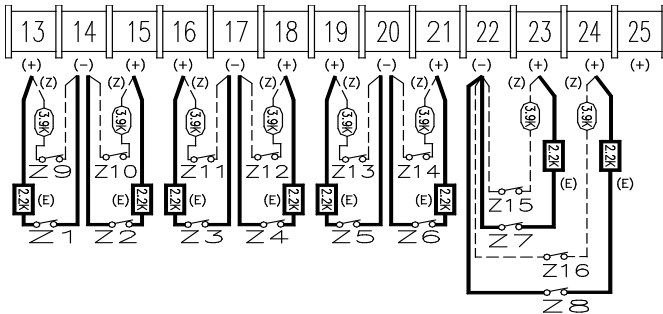

The control panel zone configuration may be expanded from 8 to 16 zones without the use of EZM Modules. To do so simply select "EZ Zone Doubling" in programming (refer to the GEM-P1664 Programming Instructions) and connect zones as shown above.

**NOTE:** If both zones in a zone-pair configuration (ex: zones 1 & 9 in the above diagrams) are to be used, then normally closed devices must be wired to both zones. The 3.9K EOL resistor must be placed at the end of the loop of the higher zone and the 2.2K EOL resistor must be placed at the end of the loop of the lower zone.

If Normally open zones for fire or panic devices are required, then the lower zone (2.2K EOL resistor) must be used and the higher zone (3.9K EOL resistor) must not be programmed for any area.

Additional expansion zone modules or wireless sensor transmitters/receivers can be used to obtain zones numbered 9 through 32

**WARNING:** Assigning a fire zone or keyswitch zones to a zone doubled will disable the respective complimentary zone. For example, if zone 8 is assigned as a fire zone, it will disable zone 16. If zone 3 is assigned as a fire zone, it will disable zone 11.

## 4-WIRE SMOKE DETECTORS

4-WIRE SMOKE DETECTOR WIRING

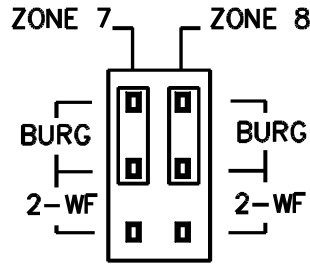
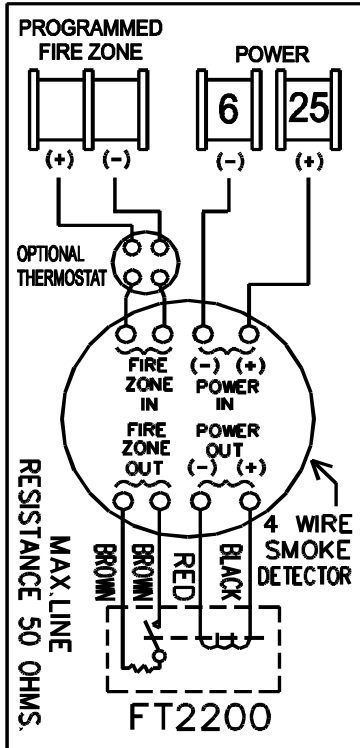

The GEM-P1664 can use conventional 12 VDC 4-wire smoke detectors. To use them, select fire zone programming option and do not select 2-wire smoke detector programming option for the desired fire zone (refer to the GEM-P1664 Programming Instructions). Set JP3 to the position as shown, if zones 7 or 8 are to be used.

Four wire smoke detectors may be connected to any programmed fire zone (1-8) as shown, within the panel. If the Zone Doubling is used (see EZ Zone Doubling Configuration), the respective complementary zones (9-16) are disabled when 4-wire smoke detectors are connected to zones 1-8. If external EZMs are used for zones 9-64, then 4-wire smoke detectors may be connected to any programmed fire zones (9-64).

Power must be obtained from terminal 25 and 6. If Fire Alarm Verification is desired to reset the smoke detectors, select this option for the desired fire zone.

## 2-WIRE SMOKE DETECTORS

2-WIRE SMOKE DETECTOR WIRING

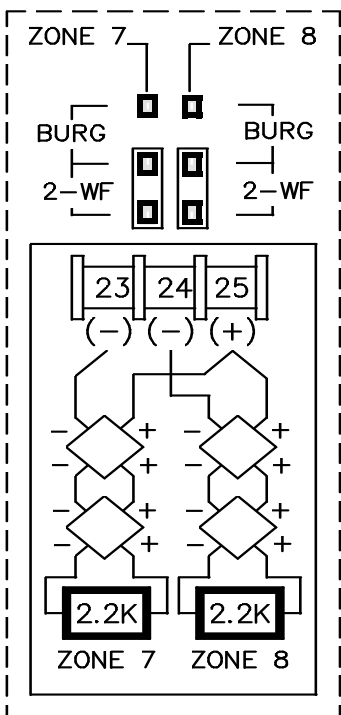

Two-wire smoke detectors can only be connected to zones 7 and 8. To use them, select fire zone programming option and select 2-wire smoke detector programming option for the desired fire zone 7 or 8 (refer to the GEM-P1664 Programming Instructions) and set JP3 to the "2-WF" position as shown. Connect the 2-wire smoke detectors as shown.

If the Zone Doubling is used (see EZ Zone Doubling Configuration), the respective complementary zones (15 & 16) are disabled when 2-wire smoke detectors are connected to zones 7 & 8.

If Fire Alarm Verification is desired to reset the smoke detectors, select this option for the desired fire zone (zone 7 or 8).

# TELEPHONE LINES

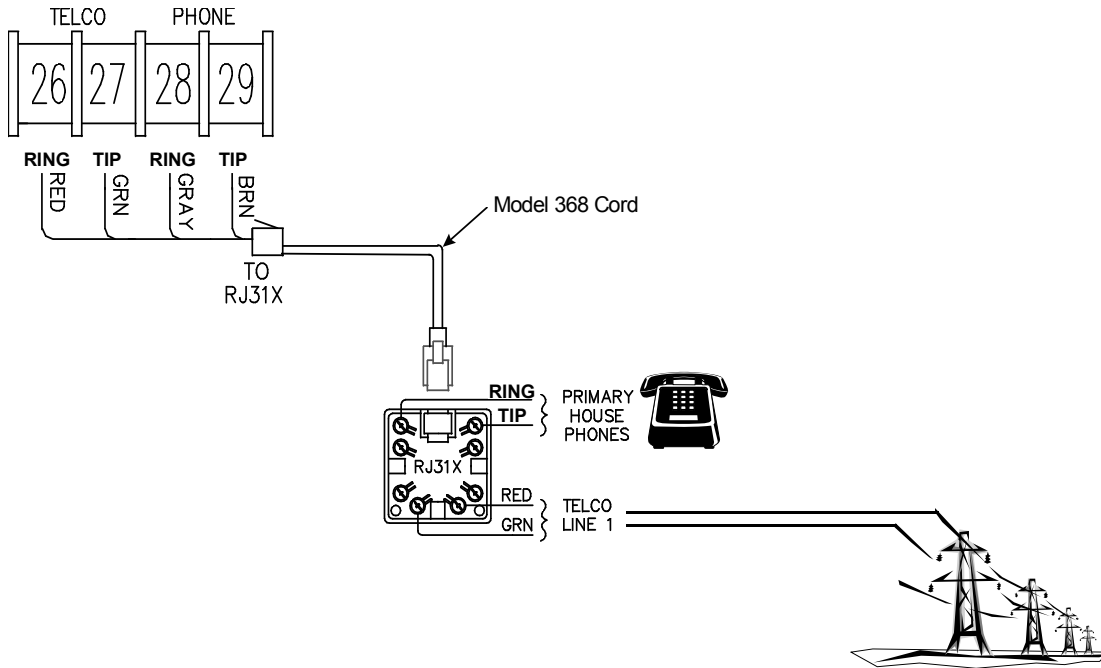

Connect the Model 368 Cord as follows: 26 (RED = Telco Ring), 27 (GREEN = Telco Tip), 28 (GRAY = Home Ring) and 29 (BROWN = Home Tip). Insert the modular plug into an approved USOCRJ31X jack (or a CA31A jack for Canadian installations). The Telco Line is used by the control panel to dial the central station and for downloading. This line should not be connected to party lines or coin operated telephones. If connected to a line with call waiting, then call waiting interrupt numbers must be programmed into the CS Telephone Numbers (refer to the GEM-P1664 Programming Instructions).

When communicating to central station and during downloading, the control panel seizes the telephone lines from the house phones, rendering them inoperative during communication. Upon completion of central station communication, the telephone line is restored to the house phones.



# KEYPAD CONFIGURATION MODE

This section will focus on configuring the GEM-RP1CAe2/GEM-K1CA and GEM-RP2ASe2/GEM-K2AS Keypads. We recommend that either a GEM-RP1CAe2 or a GEM-K1CA keypad be used for programming.

## KEYPAD INSTALLATION

Each keypad must be assigned an address number (1–7) and each requires its own configuration procedure (see CONFIGURING THE KEYPADS, which follows, and DIRECT ADDRESS KEYPAD AREA OPTIONS). At least 1 keypad must be used; only 1 is required for a single-area Commercial Burglary installation.

- **GEM-RP1CAe2/GEM-K1CA** - is a 2-line combination fire/burglary/access keypad capable of supporting 4 EZM zones. A GEM-RP1CAe2 or GEM-K1CA is recommended for use with programming.
- **GEM-RP2ASe2/GEM-K2AS** - is a utility LCD keypad combining several preset LCD words with a limited message line. **NOTE:** Due to space constraints, available messages are abbreviated and will scroll automatically.







## CONFIGURING THE KEYPADS

A total of up to 7 keypads may be connected to the panel. GEM-RP1CAe2/GEM-K1CA and GEM-RP2ASe2/GEM-K2AS keypads may be intermixed but require different configuration procedures, as described in the following paragraphs. If you have a GEM-K1CA keypad, please see the "Important Note" on page 5 regarding the differences between the GEM-RP1CAe2 and the GEM-K1CA keypad buttons. The buttons displayed below will be for the GEM-K1CA keypad.

### Configuring the GEM-RP1CAe2/GEM-K1CA Keypad







Each GEM-RP1CAe2/GEM-K1CA keypad must be configured for (a) keypad tactile beep; (b) entry sounder; (c) keypad address; (d) EZM address; and (e) zone response.

**To enter the GEM-RP1CAe2/GEM-K1CA Configuration Mode:**

1. Move jumper JP1 (located at the upper center of the control panel board) from Pins 1-2 (top two) to Pins 2-3 (bottom two). **NOTE:** See the Wiring Diagram.
2. After about 15 seconds, the display will read "XX OUT OF SYSTEM", where XX indicates the keypad address.
3. Press       and proceed as follows. (Repeat the following procedure for all keypads.)









### Keypad Tactile Beep

Upon entering the Keypad Configuration Mode, "KEYPAD BEEP ON" will be displayed, indicating that the tactile beep, which sounds when any button is pressed, is on. To turn off the tactile beep, press the  or  button (the  or  button will toggle the tactile beep on and off). Press the  or  button to continue or press the  button to exit.



### Entry Sounder





To turn off the keypad sounder during entry time, press the  or  button (the  or  button will toggle the entry sounder on and off). Press the  or  button to continue or press the  button to exit.



### Keypad Address

If more than one keypad is installed, each must be assigned a unique keypad address (that is, no two keypads may be numbered alike):  
 keypads must be numbered consecutively (missing numbers are not permitted)

To assign the keypad number, proceed as follows:



1. Enter the assigned keypad number 01–07, then press the  or  button to save. A valid number will be acknowledged by a short beep; an invalid number will be rejected by a long beep.
2. Press the  or  button to continue or press the  button to exit.



New  
Compat # 0000

**Compatibility Number (Not Applicable)**





THIS FEATURE IS **NOT** COMPATIBLE WITH THE GEM-P1664 CONTROL PANEL. **DO NOT CHANGE THIS SETTING.**

Press the  or  button to continue or press the  button to exit.

EZM Address 00

**EZM Address**

The keypad's internal EZM (Expansion Zone Module) may be utilized to provide four additional wired zones. Whether used alone or in conjunction with optional GEM-EZM series modules or other keypad EZMs, it must be assigned a unique address (or Group number, see Keypad Programming Workbook) similar to its keypad address. If no other EZMs are to be used,

designate the keypad as Group "01" at the "EZM ADDRESS 00" display. In multiple-EZM systems, enter an assigned group number "01" through "14". (Each EZM must have a unique assigned group number, starting with "01" and proceeding consecutively.) Press the  or  button to save. Press the  or  button to continue or press the  button to exit.

Zone Response 00

**Zone Response**



The normal loop response of each keypad expansion zone is 750mS, however the response time of any zone can be reduced to 50mS as follows.

1. Of the following, circle the number(s) in parentheses associated with



the zone(s) to be changed:

Zone 1=(1); Zone 2=(2); Zone 3=(4); Zone 4=(8)

2. Add up the circled numbers.

3. At the keypad, enter the sum as a two-digit number "01" through "15" on the display, then press the  or  button.

**Example.** Change Zones 2, 3 and 4 to 50mS response.

1. Circle numbers for Zones 2, 3 and 4: (2), (4) and (8).
2. Add up the circled numbers: 2 + 4 + 8 = 14.
3. Enter "14" at the keypad, then press the  or  button.



Press the  or  button to continue or press the  button to exit.

**Note:** Panel Zone Response time can also be changed in Direct Address programming (first 8 zones only). See the Programming Instructions WI1422 and WI1423 for more information.

Program Control  
Message # 1

**Program Control Message (Not Applicable)**

THIS FEATURE IS **NOT** COMPATIBLE WITH THE GEM-P1664 CONTROL PANEL.

Press the  button to continue (the display will loop back through selections, for changes) or press the  button to exit the Keypad Configuration Mode (display will read "01 OUT OF SYSTEM"). Then replace Jumper JP1 across Pins 1-2 (top two).

**Configuring the GEM-RP2ASe2/GEM-K2AS and GEM-RP3DGTL/GEM-K3DGTL Keypads**

Up to 7 GEM-RP2ASe2/GEM-K2AS keypads may be connected to the panel (Keypads 1–7). Each must be configured for a keypad address. In addition, the keypad may be configured to disable (a) touchpad backlight; (b) LCD backlight; and (c) entry sounder. Keypads are configured by the proper selection of jumpers. Refer to the label on the circuit board "fishpaper" for jumper locations and a summary of settings. If you have a GEM-K2AS keypad, please see the "Important Note" on page 5 regarding the differences between the GEM-RP2ASe2 and the GEM-K2AS keypad buttons. The buttons displayed below will be for the GEM-K2AS keypad.

**GEM-RP2ASe2 KEYPAD**

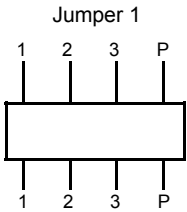

KEYPAD NUMBER	ADDRESS JUMPER			PARK
	1	2	3	
1	OFF OR ON	OFF	OFF	MAY BE USED TO HOLD SPARE JUMPER
2	OFF	ON	OFF	
3	ON	ON	OFF	
4	OFF	OFF	ON	
5	ON	OFF	ON	
6	OFF	ON	ON	
7	ON	ON	ON	

**KEYPAD ADDRESS**

If more than one keypad is installed:

 Each must be assigned a unique address (that is, no two keypads may be numbered alike).

 Keypads must be addressed consecutively (that is, missing numbers are not permitted).

Assign the keypad address number by selecting Jumpers J1–3 in accordance with the table at left.

**GEM-RP3DGTL KEYPAD**

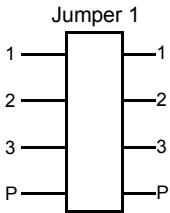

ADDRESS NUMBER	KEYPAD NUMBER						
	1	2	3	4	5	6	7
1	OFF OR ON	OFF	ON	OFF	ON	OFF	ON
2	OFF	ON	ON	OFF	OFF	ON	ON
3	OFF	OFF	OFF	ON	ON	ON	ON
P	MAY BE USED TO HOLD SPARE JUMPER						

**TOUCHPAD BACK LIGHT**

Cut Jumper A to disable touch pad backlighting to conserve 11mA standby current.

**LCD BACKLIGHT**

Cut Jumper B to disable LCD backlighting.

**DISABLE SOUNDER**

Cut Jumper to disable the sounder. (Do not disable in UL applications).



FOR HELP CALL US

NAPCO Security Systems, Inc.

333 Bayview Avenue, Amityville, New York 11701

For Sales and Repairs, call toll free: (800) 645-9445

For direct line to Technical Service, call toll free: (800) 645-9440

Internet: <http://www.napcosecurity.com>

## BASIC OPERATION



This section provides a brief overview of system operation. For detailed operation, refer to the User's Guide furnished with the keypad (see page 7 for a listing of User Guides for each keypad) and to the Keypad Programming Modes at the end of this manual. **NOTE:** Keypad displays shown in this text are for the GEM-RP1CAe2/GEM-K1CA keypads. GEM-RP2ASe2/GEM-K2AS displays will be similar, although abbreviated, and will scroll automatically.

### USER CODES & ZONE DESCRIPTIONS

(Refer to the GEM-P1664 Programming Instructions (WI1422 and WI1423) for a detailed explanation of programming). Up to 64 personal user codes may be programmed at the keypad. **NOTE:** The Area Options associated with each User Code may only be programmed in the Dealer Program Mode.

#### Default User Code.

The first code programmed should replace the default (User 01) code, "U01 123 •••-•••-•••", (1,2,3), which should not be selected as a user code.

Each user should be assigned his own dissimilar code and should be cautioned against divulging his code to anyone else. Thus should it become necessary to remove a user from the system, that one code may be cancelled without affecting other codes, and that user would then be prevented from entry. **Note:** Duplicate User Codes are not allowed by the panel; therefore a duplicate Code entered in the LCD Window will erase when  or  is pressed.

#### Changing or Canceling a User Code

To change any user code, merely program over the existing user code as described in the Programming Instructions. Similarly, to cancel a user code, blank out each number of the user code.

#### Arm/Disarm Code (Programmable in Dealer Program Mode only)

An Arm/Disarm Code may be used to arm/disarm the area in which it is programmed. Up to 6 digits may be programmed or it may be programmed as a two-digit code for the purposes of arming quickly.

#### Arm-Only Code (Programmable in Dealer Program Mode only)

An Arm-Only Code may only be used to arm the area in which it is programmed; it never has any disarm capability. Up to 6 digits may be programmed or it may be programmed as a two-digit code for the purposes of arming quickly.

#### Service Code (Programmable in Dealer Program Mode only)

A Service Code is an Arm/Disarm Code that is easily activated when needed, and dormant at other times. Intended for the occasional or temporary user (repairman, etc.) who would otherwise be denied access to the premises. It may then be used to arm and disarm just as any other User Code. A Service Code can be armed/disarmed from a disarmed state, but it cannot be armed/disarmed from an armed state, after another user code has been entered. Up to 6 digits may be programmed or it may be programmed as a two-digit code for the purposes of quicker arming.







#### Access Code

The Access Code will trip the panel's PGM2 Output Relay while armed or disarmed if the "Access Control on PGM2 Output" and "PGM2 Output Access Control Time" is programmed. The Access Code is programmed as any other user code, but without arm/disarm capability. **Note:** These systems have not been investigated by UL for compliance with UL294 (Access Control Systems).

#### Ambush Code



The Ambush Code is special user code entered by the user typically to cause a silent report to be sent to the central station. Thus, should the user be forced to disarm by an assailant, he can silently signal an emergency while appearing to be merely disarming the panel. (Check the glossary for programming required to enable this feature).

#### Zone Descriptions (GEM-RP1CAe2/GEM-K1CA only)



Zone descriptions follow the Program Code in the normal programming sequence. Program the description, up to two lines, letter by letter. Enter an identifying description for each zone. Characters are selected by pressing keypad buttons multiple times, "Cell Phone" style. Buttons  through  plus  and  are used. Press  or  to move cursor right, press  to move cursor left.

To advance to the next zone (or to any other zone), move the cursor to the displayed zone number (i.e., "01") using



**MENU** (or **FUNCTION**) and **BYPASS**. Change the zone number using keys **0** through **9P**. Enter two digits for the zone number (after entering the first digit, the cursor will automatically advance to the second digit). When the second zone number digit is entered, the cursor will automatically advance to the right, allowing the description locations to be entered. Always press  or  to save each zone description.

### ARMING AND DISARMING THE SYSTEM

In the normal disarmed state, only the green STATUS LED will be on and the display will read "SYSTEM READY". To silence an alarm, enter any User Code, then press the  or  button. Any valid User Code may be used to arm or disarm; an Arm-Only Code may only be used to arm.

#### Arming

 To arm, enter a valid User Code, then press the  button. (For all "Classic GEM-RP keypads")

 To arm, enter a valid User Code, then press the **AWAY** button. (For all "K Series" keypads)

(If a wrong code is entered, the keypad will display "INVALID ENTRY / TRY AGAIN"). The green STATUS LED will go off, the red ARMED LED will go on, and the display will read "PLEASE EXIT IN / XXX SECONDS" ("XXX" representing the programmed exit-delay time, in seconds). The exit delay will immediately start counting down toward "000", in 10-second decrements, indicating the available time remaining to exit through an exit/entry door. **Note:** If a System Trouble is displayed, there should be an attempt to correct the system trouble (for example by calling an alarm maintenance or an alarm repairman). If this cannot be done, then press the **RESET** button to allow 5 minutes to access the keypad without the system trouble display. Immediate attention should be provided, when system troubles are encountered.

#### Disarming

When the exit time has elapsed, the display will read "SYSTEM ARMED". This indicates that upon entering the premises through an exit/entry door, there will be an entry delay to allow time to disarm the panel. The GEM-RP1CAe2 or GEM-K1CA display will read "DISARM NOW / XXX SECONDS" ("XXX" representing the programmed entry-delay time, in seconds). The sounder will come on and the entry delay will immediately start counting down toward "000" in intervals of 10 seconds, indicating the available time remaining to disarm the panel. (**Note:** The sounder will "pulse" with the GEM-P1664 version 1.0. The sounder will emit a pulsing warning tone during the final 10 seconds.

To disarm the panel, enter a valid User Code, then press the  or  button.

#### Arming in AWAY MODE

AWAY MODE provides full protection of the perimeter and interior zones. Exit/Entry doors are provided with Exit/Entry delays. A "Classic" (non "K Series") keypad will display "SYSTEM ARMED", while a "K Series" keypad will display "ARMED AWAY." The RED LED will remain ON. With "K Series" keypads such as the GEM-K1CA and the GEM-K2AS, press **AWAY** to begin the exit delay process (the exit delay will immediately start counting down toward "000", in 10-second decrements, indicating the available time remaining to exit through an exit/entry door).

#### Arming in STAY MODE

STAY MODE provides partial protection by allowing free movement within the premises, while still protecting the perimeter zones. Exit/Entry doors are provided with Exit/Entry delays. A "Classic" series keypad will display "SYSTEM ARMED" with a Bypass Icon and a RED LED that remains ON, while a GREEN LED blinks. With "K Series" keypads such as the GEM-K1CA and the GEM-K2AS, pressing the STAY button bypasses all interior zones simultaneously, and arms the panel in "STAY MODE". The keypad will display "ARMED STAY". If the STAY button is pressed and held when the panel is already armed in STAY MODE, the panel will enter "Instant Mode" and eliminate the entry time delay period.





#### Instant Arming

INSTANT ARMING allows exit/entry zones to immediately go into alarm when violated, with no Exit/Entry time delay. This feature can be used to provide instant protection while you or someone else is on the premises. With the "Classic" keypads, to arm "Stay" and obtain Instant Arming, press **INTERIOR** and **INSTANT**, then enter your user code and press . With the "K Series" keypads, enter your user code and press **STAY**. Then press and hold **STAY** until keypad beeps. Instant Arming will be automatically reset on disarming.

**Auto Arming (Not for UL Installations)**

AUTO ARM allows the User to automatically arm the system at a specified time of the day and on specific days of the week. Schedule a specific closing time on any/all day(s) of the week. After a specific Fail-to-Close Window Start Time, if the user has not Armed the system during the Window Length, and the system has been instructed to "Fail-to-Close" and "Auto Arm if not closed at end of Window" then the system will arm, providing a 15 minute warning. **CAUTION:** If Automatic Interior Bypass is selected, *panel will Auto Arm in STAY Mode.*

**Delaying an Auto Arm (Not for UL Installations)**

During the 15 minute pulsating sounder warning of an Auto Arm, a User can press the  or  button, until "TO DELAY AUTO ARM / PRESS 1-4 / N" is displayed. Enter the number of hours (1-4) to delay arming, followed by the  or  button. If "DELAY AUTO ARM Y/N" is displayed, press the "NEXT/YES" button. The sounder can be silenced by pressing the  button during the 15 minute interval, but will come back on in the last 1 minute. This feature may be canceled by arming and disarming the keypad.

**EZ Arm (Easy Arm)**

EASY ARM provides one button arming for non-security critical premises. Select Easy Arming for each Keypad, with optional reporting of Easy Arm Closings as User 67. Disarming still requires a valid user code.

 To arm, **press the**  **button** for "Classic" keypads;

 To arm, **press and hold**  **or**  **for 3 seconds** for "K Series" keypads.

**Keyswitch Arming**

KEYSWITCH ARMING allows a zone input to be used to arm/disarm. The area will arm/disarm when the zone is momentarily shorted through a Momentary Switch. An end-of-line resistor must be used. Select Keyswitch Arm to optionally report as User 68.

**Maintained-Key Input Arming**

KEYSWITCH ARMING with MAINTAINED-KEY INPUT ARMING is similar to Keyswitch arming, except the zone input must remain shorted to be armed and remain open to be disarmed.

**Remote Arming (Not for UL Installations)**

REMOTE ARMING allows computer software control of arming/disarming of the system for non-security critical installations. Select Remote Arm to optionally report as User 66.















**Priority Arming**

A 2-second tone and "CAN'T ARM SYSTEM/ZONE FAULTED" displayed when attempting to arm indicates a priority condition; that is, a problem exists on at least one zone that has been designated as a Priority Zone, or a system trouble exists. The trouble(s) must be corrected before the panel can be armed. The display will read "ZONE FAULTED", then automatically scroll through all unsecured zones. If a system trouble is indicated, it will display the system trouble.

**Area Arming/Manager's Mode**

In a partitioned system, either or both secured areas may be armed (or disarmed) from the Manager's Mode (if enabled). The Manager's Mode, is a low-security mode of operation. It provides quick access to other areas without having to go to another keypad of another area.





**To arm or disarm the alternate area (for "Classic" keypads):**





-  1. Press the , ,  or  buttons to represent the alternate area.
-  2. Press the  button, then the  or  button.
-  3. Arm or disarm the selected area using your user code (the user code must be valid for that area).
-  4. To return the keypad to its "home" area, press the  button, then the  or  button.

**Note:** If the "home" keypad has been changed to the alternate area and unused for more than 5 minutes, it will revert to the home area.

## Global Arm/Disarm

In a partitioned system, any of 4 secured areas may be armed (or disarmed) from the Manager's Mode (if enabled). The Manager's Mode, is a low-security mode of operation. It provides quick access to other areas without having to go to another keypad of another area.

 To arm all areas assigned to the user, press   [User Code]  or .

 To disarm all areas assigned to the user, press   [User Code]  or .

## BYPASSING ZONES

Selective Bypass (Bypassing Specific Zones)

A Selective Bypass will bypass a specific zone that has Selective Bypass enabled, by pressing the  button followed by the zone number. The zone will be unbypassed the next time the system is disarmed. **Note: Security Bypass** is a option that requires a valid User Code to bypass zones. This feature is enabled at the factory and can be disabled using existing address (global "Enable Security Bypass"). In addition, when new User Codes are entered, the "User Area Option" must be enabled to allow the new User Code to bypass zones. See Programming Instructions (WI1422 or WI1423) for more information.

## UNBYPASSING ZONES

(Unbypassing Specific Zones)

To unbypass a specific zone that has been bypassed, press the  button followed by the zone number. The zone will be unbypassed the next time the system is armed.





## ALARM INDICATION

 If programmed to silence an alarm, **enter a valid User Code and press the  button.**

The keypad must have permission to disarm the alarm (Alarm, Pulse Alarm, PGM1 or PGM2 outputs) from the specific area. This can be done through the PC Quickloader software, Area Features Screen or Area Bell Control. See Programming Instructions (WI1422 or WI1423) for specific address locations.

Should a burglary alarm occur, the red ARMED LED will flash, and the display will alternately read "ALARM", then the zones violated. Disarm the panel; the display will read "ALARM" and will continue to indicate the violated zones until the  button is pressed or the panel is armed once again.

## FUNCTION MODE/DEALER PROGRAM MODE

The keypad can provide a wide assortment of utility functions as summarized in the Keypad Function Mode. The functions are displayed in a prompting "YES/NO" format. To skip a function, answer NO (press the PRIOR/NO button); to select and execute a function, answer YES (press the  button or the  button). The complete function list is provided here in its normal displayed sequence. However, since not all functions are designed for all systems (or intended for all users), only functions that are applicable and active are displayed. (For example, if no zones are bypassed, "DISPLAY ZN BYPASSED" will not appear). Furthermore, functions that are intended for use by the installer or servicer will not be displayed. **Note:** Functions may be manually scrolled forward or backward using the  (or ) and  buttons, respectively.

To return to normal keypad operation, press the  button. (The keypad will automatically return to its normal operating mode if no activity is detected for longer than one minute). **Note:** Due to space constraints, GEM-RP2ASe2/ GEM-K2AS message displays are abbreviated.

**Remember:** (1) Functions that are not active, not programmed and/or not applicable to the user's authority level will be suppressed and will not display. (2) Press the PRIOR/NO button to skip a function; press the NEXT/YES button to execute it. (3) The GEM-RP2ASe2/GEM-K2AS displays abbreviated messages that autoscroll.

## DISPLAY ZN FAULTS

Press the YES button to identify all unsecured zones (within the keypad's area) while disarmed. Press NEXT button to scroll through the zones. Manually bypassed zones will be indicated when displaying status.

**DISPLAY ZN BYPASSED**

Press YES button to display zones that have been deactivated. Press NEXT button to scroll through the zones.

**DISPLAY ZN DIRECTORY**

Press YES button to display a list of all programmed zone descriptions in the keypad area. Press NEXT button to scroll through the zones. To return to the system, press the **RESET** button at any time.

**ACTIVATE BELL TEST**

Press the NEXT/YES button to activate the burg relay output (while disarmed) for about 2 seconds. If the device does not sound, it may be defective.

**DISPLAY FIRE ALARM**

To display Fire Zone(s) in alarm, access DISPLAY FIRE ALARM and scroll through the zones using the NEXT button. Correct the problem, then press the **RESET** button to restore the "SYSTEM READY" condition.



**DISPLAY FIRE TRBL**

To display Fire Zone(s) in trouble, access DISPLAY FIRE TRBL and scroll through the zones using the NEXT button. Correct the problem, then press the **RESET** button to restore the "SYSTEM READY" condition.

**ACTIVATE CHIME**

Press the NEXT/YES button to sound a tone at the keypad when a Chime Zone is violated. The duration of the tone is programmable. To turn off the Chime Mode, press the NEXT/YES button at the DEACTIVATE CHIME function. **Note:** Chime is disabled for protected zones while armed. *Never Armed* zones (such as a driveway sensor) will continue to chime when the system is armed.

**RESET SYSTEM TRBL**

- ✓ System troubles normally latch and display and sound at the keypad. Pressing the **RESET** button will silence the sounder; "SYSTEM READY" will be displayed. Correcting the trouble will clear most system trouble indications, however the following system troubles require a reset system trouble be performed (enter code; access RESET SYS TRBL then press the  or  button).
- ✓ Sensor Watch

**Note:** (1) If a system trouble is not corrected, it will redisplay after 5 minutes. (2) If one or more of the foregoing system troubles appear during the first 5 minutes after power-up, they will be cleared automatically.

**DISPLAY ALARM LOG** (Not available with GEM-RP2ASe2/GEM-K2AS or GEM-RP3DGTL/GEM-K3DGTL Keypads)

Displays most recent alarm events. Line 1 displays event and date. Line 2 displays time, area and zone. To check previous alarm events, scroll back using the PRIOR button.

**DISPLAY TOTAL LOG** (Not available with GEM-RP2ASe2/GEM-K2AS or GEM-RP3DGTL/GEM-K3DGTL Keypads)

Displays most recent events of all types. Line 1 displays event and date. Line 2 displays time and, if applicable, area and zone or user. To check previous events, scroll back using the PRIOR button.

**DISPLAY FIRE LOG** (Not available with GEM-RP2ASe2/GEM-K2AS or GEM-RP3DGTL/GEM-K3DGTL Keypads)

Displays most recent fire events. Line 1 displays event and date. Line 2 displays time, area and zone. To check previous fire events, scroll back using the PRIOR button.

**DISPLAY OP/CL LOG** (Not available with GEM-RP2ASe2/GEM-K2AS or GEM-RP3DGTL/GEM-K3DGTL Keypads)

Displays most recent openings and closings. Line 1 displays event and date. Line 2 displays time, area and user. To check previous events, scroll back using the PRIOR button.

**DISPLAY SYSTEM LOG** (Not available with GEM-RP2ASe2/GEM-K2AS or GEM-RP3DGTL/GEM-K3DGTL Keypads)

Displays most recent system events. Line 1 displays event and date. Line 2 displays time and other pertinent information, where necessary, depending upon event. To check previous system events, scroll back using the PRIOR button.





**ACTIVATE FAULT FIND (Available with the Dealer Program Code)**

This troubleshooting aid will help the installer locate swingers. When accessed, two things occur:

- ✓ The loop response of each zone is set for the fastest response time.
- ✓ Causing or repairing a fault activates the sounder for about 7 seconds.

Tapping and poking at suspect points, the installer can easily locate swingers by listening for the beep. This eliminates the need of returning to the keypad to visually check after each attempt. Press the **RESET** button to restore normal operation. Arming the system automatically cancels the Fault Find Mode. **Note:** When testing wireless systems, the keypad will not beep if the signal strength is less than "3".

The "Fault Find" function (a Function Menu selection) is enabled, and normally causes all zones to give a two second beep at the keypad(s) when any zone is faulted or restored. As required by SIA CP-01, Fault Find is expanded with the following features when **Digital Dialer Report Enter/Exit Test Mode** is programmed. This option is programmed when "Enable CP-01 Feature" is selected in the Easy Program Menu:

- When Fault Find is entered, it reports to Central Station that "Test Mode" is in progress.
- Fault Find can not be initiated from an armed panel, and all digital dialer reporting is inhibited while in Fault Find.
- Fault Find Central Station Reporting Code is located at address 2053.
- Keypad will display the following warning that the system is in Fault Find: "FAULT FIND RF SIG POWER - - "
- If 24-hour zone is open at end of test, no report is sent. If a 24-hour zone is tripped and not restored during Fault Find, when the mode is exited the zone will display as "Faulted" on the keypad display.
- When Fault Find is exited by pressing **RESET**, a Fault Find Restore Report will be sent.

**ACTIVATE PROGRAM**

At the Keypad, press the NEXT/YES button to activate the User Program (Program-1) Mode or Dealer Program (Program-2) Mode, depending upon the code entered. Scroll through the program functions using the NEXT/YES button and the PRIOR/NO button.

**ACTIVATE DOWNLOAD**

Used on-site for remote downloading of a control-panel program from the PCD-Windows Quickloader Download software. Press the NEXT/YES button to initiate the data transfer.

**ENABLE DEALER MODE**

Refer to the chart on page 52.

**ENABLE USER MODE**

Refer to the chart on page 54.



## KEYPAD MESSAGES

The GEM-RP1CAe2/GEM-K1CA Keypads can display the below messages. The GEM-RP2ASe2/GEM-K2AS will display similar abbreviated messages that may scroll through two screens. **Note:** See page 7 for a listing of the keypad specific User Guides available. These User Guides contain more details regarding the various keypad messages.

**SYSTEM READY** - All zones operating; system can be armed. 1 through 4 = Area.

**ARMING YYY/XXX SECONDS** - Exit delay in progress. XXX = exit time remaining in 10-second decrements; YYY = AWAY or STAY. Arming then becomes ARMED.

**DISARM NOW/XXX SECONDS** - Entry delay in progress. XXX = entry time remaining in 10-second decrements.

**SYSTEM ARMED** - Panel armed. GEM-RP1CAe2/GEM-K1CA keypads only.

**ZONE FAULTED** - One or more zones not secured. Display status for zone description(s). GEM-RP1CAe2/GEM-K1CA only.



**CAN'T ARM SYSTEM/ZONE FAULTED** - Arming attempted with Priority Zone in trouble. Secure zone to arm.

**DAY ZONE TROUBLE** - Trouble condition on Day Zone, followed by one or more zone descriptions.

**INVALID ENTRY/TRY AGAIN** - Wrong code/time/area number entered.

**CAN'T ARM SYSTEM/PRESS RESET KEY** - Arming attempted with System Trouble present. Press the  button and then arm the system.

**ALARM** - Alarm condition, followed by one or more zone descriptions.

**FIRE ALARM** - Alarm condition on a Fire Zone. Enter your code then press the  or  button to silence the sounder. Correct the cause of the alarm, then press the  button again. Fire alarm condition, followed by one or more zone descriptions.

**SYSTEM TROUBLE** - A System Trouble display will be followed by one or more of the following error codes:

**AC POWER FAIL/E01-00 SERVICE.** Power failure. Check power transformer. Check for blown fuse or circuit breaker; general power outage.

**LOW BATTERY/E02-00 SERVICE.** Battery below 11 volts. If not recharged within 24 hours, replace it.

**COMM FAIL/E03-00 SERVICE.** Unsuccessful communication to central station. **Note:** Will also display if panel improperly programmed to report; i.e., Report Alarm, Report Codes, Subscriber ID Numbers, etc. must be programmed.

**WIRELESS TROUBLE/04-NN SERVICE.** Wireless transmitter supervisory failure. NN = transmitter number.

**WIRELESS LOWBATT/E05-NN SERVICE.** Rf transmitter low battery. NN = transmitter number.

**SYSTEM TROUBLE/E06-NN SERVICE.** Rf receiver response trouble. NN = receiver number.

**SYSTEM TROUBLE/E07-00 SERVICE.** Download failure.

**SYSTEM TROUBLE/E08-00 SERVICE.** Telephone line failure (system trouble displays after a fixed 60 second delay).

**SYSTEM TROUBLE/E09-00 SERVICE, NO PANEL PROGRAM.** System cold start not programmed after address 2286.

**SYSTEM TROUBLE/E10-NN SERVICE.** Keypad response failure. NN = keypad number.

**SYSTEM TROUBLE/E11-NN SERVICE.** Keypad tamper cover removed. NN = keypad number.

**SYSTEM TROUBLE/E12-NN SERVICE.** Expansion zone module failure. NN = module number.

**SYSTEM TROUBLE/E13-NN SERVICE.** EZM module cover removed. NN = module number.



**SYSTEM TROUBLE/E14-NN SERVICE.** Relay board response failure. NN = relay board number.

**SYSTEM TROUBLE/E15-NN SERVICE.** Wireless transmitter tamper cover removed. NN = transmitter number.

**SYSTEM TROUBLE/E16-NN SERVICE.** Receiver jammed. NN = receiver number.

**SYSTEM TROUBLE/E17-NN SERVICE.** Receiver cover removed. NN = receiver number.

**SYSTEM TROUBLE/E18-NN SERVICE.** Key fob RF transmitter low battery. NN = key fob transmitter number.

**SYSTEM TROUBLE/E19-00 SERVICE.** Internal user memory error. Select RESET SYSTEM TBL. Press the  or  button, then the  button.

**SYSTEM TROUBLE/E20-00 SERVICE.** Internal dealer memory error.

**SYSTEM TROUBLE/E22-NN SERVICE.** No trip detected on PIR Supervision Zone within programmed Sensor-Watch time. NN = Zone number. To reset, press NEXT/YES button at "RESET SENSOR MSG" function display.

**SYSTEM TROUBLE/E27-00 SERVICE.** Printer Failure. Call installing company for service.

**SYSTEM TROUBLE/E39-00 SERVICE.** Receiver capacity error.

**SYSTEM TROUBLE/E40-00 SERVICE.** RF Self-Test failure.

**SYSTEM TROUBLE/E41-NN SERVICE.** Trouble condition on a Fire Zone. Press  button to silence the sounder. Correct the trouble, then press the  button again.

**SYSTEM TROUBLE/E51-00 SERVICE** - Alarm Output Supervisory.

**SYSTEM TROUBLE/E99-00 SERVICE.** Keypad Panic shorted too long (RP2/K2 and RP3/K3 keypads).

**NN OUT OF SYSTEM** - Keypad inoperative. NN = keypad number.

**FAULT FIND/RF SIGNAL POWER** - Fault-find Mode activated.



# GLOSSARY

**Note:** *Displayed messages shown are for the GEM-RP1CAe2 and/or GEM-K1CA keypads. Other keypad messages are similar but abbreviated. Refer to the GEM-P1664 Programming Manuals (WI1422 and WI1423) for specific address numbers.*

## **Abort Delay** (Do not program for UL Applications)

An Abort Delay is a delay period that allows cancellation of the central-station report by disarming the control panel before a report is sent. If Enable CP-01 Limits is enabled, the Abort Delay is 30 seconds (which cannot be removed but can be adjusted to within the CP-01 specification of 15-45 seconds). In addition, if an attempt is made to change the Abort Delay to less than 15 seconds or more than 45 seconds, the time will be entered as 30 seconds. If enable CP-01 Limits is NOT enabled, the factory delay time will be set at 30 seconds, and can be deleted or increased to 255 seconds. Refer to "Enable CP-01 Limits" in this glossary. Enable program zones for *Abort Delay* and select an *Abort Delay Time*. Also, a *Pre-Alarm Warning* may be selected for zones allowing a keypad indication of alarm with no alarm outputs or central station reporting for the duration of abort delay time.

## **AC Failure; AC-Fail Report Delay**

If AC power is removed from the control panel, "AC POWER FAIL/E01-00 SERVICE" will display at the keypad with a flashing "SYS/TRBL" icon as a reminder and a pulsing sounder. Press  to silence the sounder; the "SYS/TRBL" icon reminder will remain on and "SYSTEM READY" will appear in the display. If a User Code is entered within 5 minutes, the panel may be armed. After 5 minutes, the system trouble will again display.

*AC Failure* may be programmed to activate the *Alarm Output*, *Pulsed Alarm Output*, *PGM1 Output*, *PGM2 Output*, *Relay Outputs* and/or report to a central station by selecting *AC Fail Report Event Telco 1*, *AC Fail Report Restore Telco 1*, *AC Fail Report Event Telco 3*, *AC Fail Report Restore Telco 3*. The AC Trouble Fail Display, AC Fail Logging, and AC Fail Report to the central station will occur immediately unless an AC Fail Report Delay is programmed.

## **Access Control; Access Control (Panel Access) on PGM2 Output; PGM2 Output Access Control Time; Panel Access**

**Note:** The GEM-P1664 has not been evaluated by UL for compliance with UL294 (Access Control Systems).

The PGM2 Output can be programmed to activate for a programmable period of time (2 to 254 sec.). This allows it to be used for access functions such as opening and closing a garage door, or remotely activating an electric door strike through an RB1000 relay. This is achieved by programming a new KeyFob option, *Access on PGM2 Output*, into the Aux. 1 or Aux. 2 option locations on the Wireless KeyFobs screen. This feature also requires a valid time to be entered into the *PGM2 Output Access Control* in the Time Selection Screen.

If Access Control on PGM2 Output is selected, entering the Access Code (see User Code Programming in Easy Menu Driven Mode Programming) while disarmed will trip the panel's PGM2 Output. (This is commonly used to activate a door strike for the purposes of remotely unlocking a door). Each keypad is individually selected for Panel Access. Also program PGM2 Output Access Control Timeout. **Note:** Do not program the PGM2 Output as an output on alarm. Do not program *Keyfob Chirp on PGM2*, unless *Enable Bell Output on RF Arming* is selected also.

Panel Access is selectable for any keypad 1–7 by selecting the appropriate Area Option of any User Code (see User Code Programming in Easy Menu Driven Mode Programming); select the Panel Access option for those keypad numbers (1–7) that are to respond to the User Code. However, if the Access Option is programmed, the code will no longer function as an Arm/Disarm Code. Entering a valid code at the keypad will cause the PGM2 output on panel to turn on for the programmed time. The RB1000 Relay may be used to activate a door strike, and power to the door strike should be supplied from an independent power source.

## **Access Number for Outside Line (CS Receiver Telephone Number Access)**

Some subscribers will have a telephone system that requires one digit to access an outside line. The first dial tone encountered (prior to the access number) may have a frequency that is different from that of the accessed dial tone (440Hz). One or more 4-second Pre-Dial Delay "D"s may be entered before any of the CS Receiver Telephone Numbers instead of a dial tone with frequency "E". See Pre-Dial Delay; Telephone Numbers. (**Note:** The panel features automatic dial-tone detection and will normally not require any "E"s. To disable this feature, see *CS System Report Options* in the Programming Instructions WI1422 and WI1423). If the subscriber's system uses an access number, contact the telephone-equipment supplier to find out if a dial tone other than 440Hz is received prior to dialing the access number. If the communicator must delay before dialing the access number instead of attempting to recognize the dial tone, find out how many 4-second delays must be programmed.

**Alarm on Day Zone** See Day Zone

## **Alarm Outputs (See Wiring Diagram for UL requirements); Alarm Output Duration**

The GEM-P1664 has three outputs: Alarm (Burg. & Fire), PGM1 and PGM2. The following table summarizes wiring for signaling an alarm in typical installations. See Time Selection for timeout durations.



OUTPUT	WIRING	REMARKS
Alarm Output (Burg.)	3(+) & 4(-)	Single Bell Output; program Alarm Output for Burg. See System Options in the Programming Instructions WI1422 and WI1423.
Pulse Alarm Output (Pulsed)	3(+) & 4(-)	Single Bell Output; program Pulsed Output for Fire. See System Options in the Programming Instructions WI1422 and WI1423.
PGM1 Output	5(+) & 7(-)	Programmable Output. See System Options in the Programming Instructions WI1422 and WI1423.
PGM2 Output	5(+) & 8(-)	Programmable Output. See System Options in the Programming Instructions WI1422 and WI1423.

### Alarm Outputs

In UL installations, (1) see Time Selection for timeout requirements; (2) Fire zones must be programmed for Pulse Alarm Output, and the option "Change Pulse Alarm to Cadenced Alarm" must be programmed. **Note:** For PGM1 and PGM2 are Lug Active-Low Outputs.

**Alarm; Alarm Restore Telco 1/Telco 3** See Report Telco 1/Telco 3

**Alarm; Alarm Restore Telco 2** See Backup Report on Telco 2

### Alarm Supervisory

An Alarm Supervisory indicates that there is an open in the circuit to the Alarm (Bell) Output and requires immediate attention. A 2.2K EOL resistor is required. See wiring diagram.

### Ambush (Keypad Ambush); Ambush Codes; Enable Global Ambush

There are two types of Ambush Codes: (1) A 2-digit code (prefix) that is entered immediately prior to (and as part of) the regular User Code and (2) A separate and unique User Code. Disarming with an Ambush Code will cause a silent report to be sent to a central station. Thus, should a user be forced to disarm, he can silently signal an emergency while appearing to be merely disarming the system. The Ambush Zone will automatically report when programmed to report an alarm.

*Ambush Type 1:* (a 2-digit prefix code), this type must not be used in a SIA CP-01 compliant system. Enable as follows: (a) select "Ambush to Report Event Telco 1/Telco 3"; (b) select "Enable Global Ambush Code"; enter "Global Ambush Code"; and (c) enter an "Ambush CS Report Code". Each keypad is enabled for "Ambush" individually.

*Ambush Type 2:* (a separate and unique user code), this type must be used in a SIA CP-01 compliant system. Enable as follows: In the Easy Menu Driven Program Mode, the menu selection "Enter User Code" is used to program a user code with a "blank(•) 5" in the area for which the Ambush Code will be used. Enable all other locations and program as follows: (a) select "Ambush to Report Event Telco 1/Telco 3"; (b) enter an "Ambush CS Report Code". Each keypad is enabled for "Ambush" individually.

Be sure to inform the user what their Ambush Code is, and that the Arm/Disarm Code must be entered less than 10 seconds after the Ambush Code for an ambush report to be sent. When "ENABLE GLOBAL AMBUSH" is selected and no Ambush code has been entered and the keypads have been selected for AMBUSH, then the AMBUSH CODE will default to "99".

**Answering Machine Pickup Without Line Seizure** See Callback-Method Download.

### Anti-Jam Communicator Time

If the communicator does not detect a dial tone within 12 seconds, the Anti-Jam feature will be activated. That is, the communicator will go off line for a 16-second anti-jam interval in order to free the telephone circuit from an incoming call, then make another 12-second attempt at dial-tone detection. If still unsuccessful, the communicator will again go off line for 16 seconds, then proceed to dial anyway.

### Areas; Zone Area 1–Zone Area 4; Priority Area Arming

Although the default program will automatically set up Zones 1 through 8 for Zone Area 1, the panel may be partitioned into two areas. Every zone must be assigned to at least one area to be used. At least one zone must be assigned to Area 1. If a zone is selected for both areas, that common zone will not arm until both areas are armed. If any area disarms, the common zone will disarm.

#### Keypad Area Assignments

Silencing Alarm Area (determines which alarms an area may silence);





Subscriber Opening/Closing ID Numbers and Event ID Numbers (if reporting);

System Trouble Subscriber ID Number

If "Priority Area Arming" is selected, the Priority Area must be armed before the Arming Area can be armed.

### Auto-Arm if not closed at end of Window; Closing Window; Fail to Close (Not for UL Installations)

AUTO-ARM can be programmed to arm at a specific closing Time (such as: 17:00 representing 5:00 pm), for a notification length of time (such as: 00:02 representing 2 minutes), and a FAIL-TO-CLOSE has been enabled for a specific day of the week and area, and

Auto Arm if not closed at end of window. When the start time is reached, the display will notify the occupants that an Auto-Arm will be initiated in the notification period length of time. After that period has expired, a 15 minute period will count down to Auto-Arm with the sounder pulsing. Auto-Arming may be canceled by arming and disarming the panel. An auto-Arm will be reported as User 33. Auto Arming can be delayed from 1 to 4 hours by pressing the  or  button during the 15 minute Auto Arm Period until "TO DELAY AUTO ARM" is displayed and press the number of hours to delay followed by the  or  button.

#### Auto Output Test on Arming

If selected, this will activate the Burglary Output briefly 10 seconds after the area is armed. If the alarm does not sound, the device may be defective.

#### Auto-Bypass (Do not program for UL installations); Auto-Bypass Re-entry

Zones programmed for "Auto-Bypass" will be bypassed (automatically removed) if in trouble when arming. A momentary beep will sound at the keypad to warn that the system has been armed without the protection of the auto-bypassed zone. (Note that the exit/entry door should not be used for Auto-Bypass, otherwise the Exit/Entry Zone will be auto-bypassed). **Note:** A zone in trouble that is not programmed for "Auto-Bypass" will cause an alarm on arming after a 10-second arming delay.

If "Auto-Bypass Re-entry" is selected, securing a zone that is programmed for Auto-Bypass, while armed, will cause that zone to re-enter the system in an armed state.

#### Auto Interior Bypass/Easy Exit (STAY MODE) See Interior Stay Zones

#### Auto-Reset; Auto-Reset After Burglary Output Timeout (Do not program for UL installations)

If a zone detects an alarm condition and is selected for "Auto-Reset", it will automatically rearm itself as soon as the alarm condition is cleared. Auto-Reset may be delayed to occur after the Alarm Output timeout period by selecting "Auto-Reset After Burglary Output Timeout" and "Auto-Reset". Zones that are not programmed for "Auto-Reset" will not be capable of signaling another alarm until (a) the cause of the alarm has been corrected and (b) the control panel is disarmed. Also see Swinger Shutdown.

#### Auto Status Disable

For high security Installations, the automatic scrolling of Zone Faults can be disabled. When any zone is faulted, the display will read, "Zone Faulted".

#### Backup Report on Telco 1/Telco 2

If "Backup Reporting on Telco 1/Telco 2" is selected and the communicator does not reach the first telephone number (Telco 1) after three attempts, seven attempts will be made to reach the second telephone number (Telco 2). Enter Subscriber Identification Numbers for Telephone 2 and other information required for Telephone 2. Also program Backup Report on Telco 2. Any zone programmed to report to Telco 1 will backup report to Telco 2. **Note:** Subscriber Identification Numbers for both Telephones 1 and 2 must be entered, even if they are the same. Any restore will also first transmit to Telco 1 then Telco 2. The alarm and restore may not be transmitted to the same telco telephone number.

#### Battery

12Vdc standby power source in the control panel is used to provide backup protection in the event of a power loss. The battery is an integral part of the system and must be installed, even if ac power is present. Change the battery every 5 years or as required.

#### Burglary Output See Alarm Outputs

#### Call Waiting See Disable Call Waiting

#### Callback-Method Download; Disable Second Call Answering Machine Override (MUST program for UL installations); Disable Callback Download (MUST program for UL installations); Callback Telephone Numbers; Disable Keypad Function-Mode Download; Answer on Ring Number

Data may be downloaded remotely to the panel after a programmed number of rings (3 to 15) and a control-panel confirmation callback. Program the "Number of Rings"; if not programmed, the panel will pick up after 15 rings.

The feature "2nd Call Answering Machine Override" allows downloading after (1) the panel detects 1 or 2 rings; (2) the panel does not detect another ring for 8 seconds; (3) the panel detects another ring within the next 22 seconds. At this point, the panel will connect and allow the panel to communicate with the downloading computer. In this way, the panel overrides the answering machine. The answering machine will pick up on its programmed number of rings, as usual. **Note:** The number of rings programmed into the panel must exceed that of the answering machine.

Program "Disable Callback Download" to prevent unauthorized downloading to an unattended panel. Program "Disable Answering Machine Download" to inhibit downloading to a telephone connected to an answering machine. Program "Disable Function-Mode Download" to prevent downloading at the keypad.

#### Cancel; Cancel Code; Cancel Report to Telco 3; Cancel Window Duration (Report Cancel Window)

CANCEL is the preventing of a report from being sent by entering a user disarm code. If the area is disarmed during Entry Delay or



the "Pre-Alarm Warning", then no report will be sent and no messages will be displayed at the keypad. If the area is disarmed during the Abort-Delay, then an "Alarm Canceled" will be displayed at the keypad and no report will be sent. If the area is disarmed during or within the Cancel Window Duration, then an "Attempting to Cancel" will be followed by an "Alarm Canceled" for a successful cancellation. Otherwise, the report had been sent and will be responded appropriately to by the Central Station. Cancel must be provided with a Central Station Telephone Number, proper Subscriber O/C Report ID Numbers and a valid Cancel Code to Telco 3. A Cancel Window ("Report Cancel Window") is the duration that the system will attempt to cancel a report, after the report is sent.

**Cancel Next Test Timer Report on Any Report** See Test Timer

**Central Station Receiver Data Format** See Data Format

### **Chime (Displays "MONITOR" on GEM-RP2ASe2 Keypads); Chime Duration**

This annunciator feature may be used on any zone to sound a tone at the keypad while disarmed when the zone goes into trouble. Access the ACTIVATE CHIME function to enable or disable the Chime Mode. This feature is programmable by zone and "Chime Timeout Duration". A time must be programmed for the chime to function. **Note:** "0" means no chime value is programmed.



### **Chime Zone 2**

CHIME2 adds an additional tone onto the regular "Chime Zone" tone. It allows some zones to have distinctive annunciator chimes to identify the door or zone. "Chime Zone" must be selected on any keypad for all area keypads to chime. While the standard chime zone sounds a steady tone when a chime zone is faulted, Chime 2 will sound a pulsating tone when a Chime 2 zone is faulted. This can be used to help the customer easily identify the door which has been opened. Program the zone as Chime 2 in the Zone Features screen. This feature is programmable by zone and "Chime Timeout Duration".

### **Chirp Output on Keyfob Arm/Disarm**

If enabled, when arming with a keyfob, the PGM2 output chirps.

### **Clear Program**

Caution: Erases the dealer program. Use this feature to start a new customized default program. Access Address Location, then press the  or  button.

### **Closing Report; Closing Report Only on Conditional Closing; Conditional Closing; Include Selective/Group Bypass In Conditional Closing/Status; Status Report; Disable Closing Report**

On arming, the communicator can transmit a unique Closing Code for each user and a status report that identifies the problem zone to the central station. Note that Subscriber Identification Numbers and a Closing Code and/or conditional closing code must be entered for any closing report.

Select which users will report closings for each telephone number, even if "Closing Report Only on Conditional Closing" is selected. Normally, a closing report will consist of the Closing Code and the number of the user that armed. If the user armed with an auto-bypassed zone (or selective/group bypassed zone if "Include Selective/Group Bypass In Conditional Closing/Status" was programmed), the Conditional Closing Code will also be sent.

Select "Closing Report Only on Conditional Closing" to report only when arming with an auto-bypassed zone (and selective-bypassed zone if "Include Selective in Conditional Closing/Status" is programmed).

Select "Status Report" to send a closing followed by a status report that identifies the problem zone(s). A typical Status Report is represented by the following example.

Example (4/2 Format). A burglar breaks into a commercial establishment during the night, breaking the window foil on Zone 5. The Open/Close Subscriber Identification Number is "1234"; the Alarm Code for Zone 5 is "3,5" (Burglary Zone 5); the Subscriber Identification Number is "6789"; the Closing Code is "C". The communicator will send the following report to the central station.

When alarm occurs:



"6789 35" – Alarm, Zone 5

Closing Report:

"1234 C1" – Closing, User 1 (User 1 returned, inspected damage & rearmed; the same transmission would occur for User 11, 21, 31, etc.)

"1234 F5" – Trouble, Zone 5 (zone status at time of closing: Window foil still broken; Zone 5 auto-bypasses, repair required; the same transmission would occur for Zone 15, 25, 35, etc.).

### **Cold Start**

**Caution:** Erases the entire program (codes, schedules, etc.), and loads the following defaults: 8 hardwire zones (Zones 1-8) are programmed in Area 1, with no other zone features enabled and no alarms generated. In addition, a Default User 1 Code of "123" is enabled as an Arming Code in Area 1, and after powering up, the installer is required to enter Program Mode using the Dealer Program Default Code of "456789". Press  to exit the EZ Program menu. Access Location Cold Start, then press the  or  button.

### **Data Format**



Ask the central station which of these formats to use.

**Two-Digit or 4/2 Format.** Some central-station receivers require that a four-digit Account Code followed by a two-digit Alarm Code be sent in each report. Example. In a certain installation, the Alarm Subscriber Number is "1234"; a burglary alarm occurs on Zone 1. The Alarm Code for Zone 1 is "3". The communicator will send "1234 31" (Account No. 1234; Alarm, Zone 1). 1400Hz Handshake/Kissoff. 1400Hz Handshake overrides 2300Hz Handshake if both are selected. 2300Hz Handshake/Kissoff. Used with the following receiver formats: Radionics, DCI & Franklin Slow; Radionics Fast.

- ✓ **Zone Number on Pulse Alarm.** If selected, an Alarm Code need not be programmed (the zone number will replace the Alarm Code), however codes for restore, trouble, etc. are still required. Thus, in the foregoing example, if "E" is the designated Restore Code, and Zone 24 trips and is restored, the communicator will send "1234 24" (Account No. 1234; Alarm, Zone 24) followed by "1234 E4" (Account No. 1234; Zone 24 Restored).
- ✓ **Single-Digit (Pulse Only) Format.** The single digit sent for a particular digit of the zone number.
- ✓ **Sum-Check Format.** Sum Check is a sophisticated data format used to enhance the speed and check the accuracy of the received transmission. This format should be preferred whenever the central station is capable of receiving it. After transmitting the Subscriber Identification Number and the Alarm Code, the communicator sends a verifying digit that is the sum of both. The receiver compares the verifying digit with the sum of the other numbers to check transmission accuracy. This feature eliminates the need to repeat data and saves time.
- ✓ **3/1 with Extended Restores.** Some receivers require a three-digit Account Code followed by a single-digit Alarm Code. Example. In another installation, the Alarm Subscriber Number is "123"; an alarm on Zone 1 is restored. The Restore Code for Zone 1 is "E,1". The communicator will send "123 E" (Account No. 123 Restored); followed by "EEE 1" (Restored, Zone 1).
- ✓ **Modem Formats.** Modem formats (SIA, Point ID) are preset and automatic but require a Type for each zone. Program Zone Type as follows: Fire\* = "1"; Panic = "2"; Burglary = "3"; Holdup = "4"; Gas Alarm = "7"; Heat Alarm = "8"; Auxiliary Alarm = "A" (Keypad displays "0"); 24-Hour Aux. Alarm = "B".
- ✓ **Pager Formats.** The control panel has provisions for dialing a pager phone number. The panel will wait for ringing, wait for silence, then send its data. Caution: Because there is no handshake/kissoff, this feature should only be used for Double Reporting; it may not be used for Backup Reporting. Only one report is sent for any call. Pager digits are limited to "0" through "9". Digits represented by "A" through "F" will be converted to "0"s for transmission purposes. Pager formats are 10 digits, arranged as illustrated by the following examples.

Alarms, restores, etc. are transmitted in a 3-2-4 arrangement representing Report Code, Descriptor and Account Number.

Example 1. Burglary, Zone 22 (Report Code = "3").

Transmits: 003 22 1234, where

003 = Report Code (always two zeros + programmable Report-Code digit, 0–9);

22 = Descriptor (2-digit descriptor, zone number: 01–64);

1234 = Account Number (4 digits, programmable).

Openings, closings, etc. are transmitted in a similar arrangement

Example 2. Closing, User 12 (Closing Code = "8")

Transmits 008 12 1234, where

008 = Report Code (always two zeros + programmable Opening/Closing digit, 0–9)

12 = Descriptor (2-digit descriptor (user number: 01–32);

1234 = Account Number (4 digits, programmable).

Keypad Report Codes and System Report Codes are transmitted in the same format.

**Compatible Receivers.** The following receivers are compatible with the GEM-P1664:

- ✓ **FBI CP220.** Formats: Ademco Slow; Silent Knight Slow; Silent Knight Fast; DCI; Franklin Slow; SIA; Radionics Slow; Radionics Fast; Universal High Speed.
- ✓ **Ademco 685.** Formats: Ademco Slow; Silent Knight Slow; Silent Knight Fast; DCI; Franklin Slow; Radionics Slow; Radionics Fast; Universal High Speed; Ademco Point ID.
- ✓ **Radionics 6500.** Formats: Ademco Slow; Silent Knight Slow; Silent Knight Fast; DCI; Franklin Slow; Radionics Slow; Radionics Fast; Universal High Speed.
- ✓ **Osborne-Hoffman Quickalert.** Formats: Ademco Slow; Silent Knight Slow; Silent Knight Fast; DCI; Franklin Slow; SIA; Radionics Slow; Universal High Speed; Ademco Point ID.
- ✓ **Silent Knight 9000.** Formats: Ademco Slow; Silent Knight Slow; Silent Knight Fast; DCI; Franklin Slow; Radionics Slow; Radionics Fast; Universal High Speed; SIA.

## Date/Time

A Date/Time can be set in the Keypad Dealer Program Mode or Quickloader program. "Enable Keypad Set Date/Time Message" will automatically request the date and time at the keypad after extended power failures (if enabled).

## Day Zone (Open; Short); Alarm on Day Zone; Disable Auto-Reset on Day Zone; Reset Day Zone with Arm/Disarm Only; Day Zone Trouble on Open

A Day Zone will give an audible and visual indication at the keypad if there is a problem on the loop while disarmed. Open- and short-circuit conditions are programmed separately, by zone. This feature may be used to warn of a problem (a break in a window foil, for example) during the day, when the panel is not normally armed. When the Day Zone is tripped, "DAY ZONE TRBL" and the zone number(s) will alternately display at the keypad and the sounder will pulse. Press the **RESET** button to silence the sounder and reset the keypad. "ZONE FAULT" will be displayed until the condition is corrected. If **Reset Day Zone With Arm/Disarm Only** is programmed, reset the Day-Zone indication at the keypad. A User Code is required to reset the keypad display. If **Alarm on Day Zone** is programmed for a zone, a Day Zone condition will cause the alarm outputs programmed for that zone (sirens, relays) to activate. If **Day Zone Trouble on Open** is programmed, a zone configured as a 24 hour zone reports an alarm on short and a Day Zone trouble



on an open loop.

**Note:** (1) If a zone is programmed for both "Day Zone Open" and "Day Zone Short", either condition must be reset before the other can activate. (2) Day Zone Short will not function if No EOL Resistor is also programmed. Report Trouble or Trouble Restore is programmed in conjunction with Day Zone Open/Day Zone Short and Trouble on Open/Trouble on Short (the trouble reported will be that programmed under Day Zone Open and/or Day Zone Short).

**Note:** Do not program a Day Zone for 24-hour protection. The keypad will annunciate as a Day Zone but the panel will transmit an Alarm Code and a Trouble Code when tripped.

### Dealer Security Code

The factory-programmed Dealer Security Code is "456789". Use this code to enter the Easy Menu Driven Mode (Dealer Program Mode) to program (or change) the Dealer Security Code. The Dealer Security Code is needed to enter the Dealer Program Mode, thus allowing the dealer to program codes, zone features, reporting features and zone descriptions. This code should be changed as required.

### Dial-Tone Detection; Disable Auto Dial-Tone Detection

The panel features automatic dial-tone detection to ensure that a dial tone is present before the communicator dials. To disable this feature, program an "8" in Location 0394.

When an "E" is programmed before the first digit of an outside telephone number, the communicator dial-tone detection circuit is set to detect the standard 440Hz dial tone. The "E" is generally entered in the location immediately preceding the telephone number. It may be necessary to program at least one 4-second pre-dial delay before a dial-tone detection "E". With certain nonstandard exchanges, pre-dial delay "D"s may be used without a dial-tone detection "E". (See Access Number for Outside Line; Pre-Dial Delay; Telephone Numbers)

### Digital Dialer Report Enter/Exit Test Mode

**Initiation Report.** At the initiation of a test, the control panel sends a message to the central station that a test is in progress. The "Fault Find" function (a Function Menu selection) is enabled, and normally causes all zones to give a two second beep at the keypad (s) when any zone is faulted or restored. As required by SIA CP-01, Fault Find is expanded with the following features when **Digital Dialer Report Enter/Exit Test Mode** is programmed. This option is programmed when "Enable CP-01 Feature" is selected in the Easy Program Menu:

- When Fault Find is entered, it reports to Central Station that "Test Mode" is in progress. On completion of the report, a Ring-Back will be given.
- Fault Find can not be initiated from an armed panel, and all digital dialer reporting is inhibited while in Fault Find.
- Keypad will display the following warning that the system is in Fault Find: "FAULT FIND RF SIG POWER - -"
- If 24-hour zone is open at end of test, no report is sent (GEM-P1664). If a 24-hour zone is tripped and not restored during Fault Find, when the mode is exited the zone will display as "Faulted" on the keypad display.
- When Fault Find is exited by pressing , a Fault Find Restore Report will be sent, and upon completion of the report a Ring-Back will be given.

### Disable Call Waiting (Touch-tone® Dialing Only)

A digital communicator connected to a telephone line with Call Waiting may be disrupted by this feature. However, most lines with Call Waiting also have Selective Call Waiting, which permits the feature to be turned off by dialing a "\*70" just before the telephone number. A "\*" will be dialed by programming a "B".

If the installation has the Call Waiting feature, be sure that it also has Selective Call Waiting, and confirm the disable code with the telephone company. Then program this code ("B70") directly before the phone numbers (after dial-tone detection or pre-dial delay) in the telephone-number locations. See Telephone Numbers.

**Caution:** Should the user cancel his Call Waiting service, the communicator will dial a wrong number unless the phone number is corrected.

### Disable Call Waiting on 1<sup>st</sup> Attempt

Cancel "\*70" after the 1<sup>st</sup> dial attempt. Default is disabled. When enabled, this option will dial the Central Station telephone number as it is programmed in the panel. If the first communication is unsuccessful, the next and remaining dial attempts will remove the \* star button (entered as a "B" from the keypad) and the 2 subsequent digits from the Central Station telephone number.

**Disable Callback Download** See Callback-Method Download

### Disable Code Required for Easy Bypass (Do not program for UL installations)

Any or all zones (1-64) programmed for Selective Bypass may be removed from the system, but each must be removed separately. Refer to BYPASSING ZONES in Section 3 for operation. Security Bypass, recommended for commercial applications, requires entry of a valid user code. Easy Bypass, recommended for residential applications, is selected by programming Disable Code Entry for Easy Bypass; this will permit bypassing/unbypassing zones without the need of entering a code. Do not program this feature in high-





security applications. When one or more zones is bypassed, the BYPASSED reminder on the GEM-RP1CAe2 keypad will display. **Disable Code Required for Easy Bypass** is enabled by default.

**Disable Function-Mode Download** See Callback-Method Download

#### Disable Openings/Closings

Provides the flexibility of disabling openings and/or closings for any area(s).

#### Disable Handshake on Xmit (All Formats)

Causes data transmission to wait one second after dialing a pager telephone number before sending data.

#### Disable PGM2 Clear on Disarm

PGM2 will not clear when a user code is entered to disarm.

#### Disable System Trouble Audible Timeout

If the trouble occurs when disarmed, the sounder will now automatically time out in 10 minutes, without the need to press [RESET]. **(MUST be programmed in UL installations)**

#### Disable Wait-for-Silence (Pager Format)

Causes data transmission to start immediately after the pager telephone number.

#### Disable Zone Fault Scrolling/Disable Auto Status

Non 24-Hour Zones that are open (or shorted) normally display "ZONE FRULTS" (while disarmed) followed by the zone number(s) and description(s). In high-security applications, program Disable Auto Status. Unsecured zones will then be indicated by a "ZONE FRULTED" display without zone numbers displayed. Status may be displayed manually using the DISPLAY STATUS function.

**Double Reporting** See Report Telco 3

#### "E" Lugs (E5, E15, E19) (Do not program for UL installations)





**E5** - Lug E5 is used for Line Seizure. It is normally at 12V and when the telephone line is seized it goes to approximately 1V DC.

**E15** - Lug E15 is used for Armed Status, either Armed Stay or Armed Away. When the system is armed it goes to approximately 1V DC. For multiple area systems: If only 1 area, Lug E15 goes active low when area 1 is armed; if 4 areas, areas 1 through area 4 have to be armed for Lug E15 to go active low.

- **Lug E15 Area 1 Armed Away Only:** When enabled, Lug E15 will activate when area 1 is armed Away. **Note:** If this feature is not selected, the E15 Lug will, by default, activate when the system is armed (all areas).

**E19** - Lug E19 is the Listen in Lug. It is an input and when it is forced low the panel will silence the keypad sounder and bell outputs so that the Veri-phone can listen to activity at the residence. See Veri-Phone (WI783): Silence All Outputs During Audio Session. Use Napco Part No. WL1 for field wiring.

#### Easy Exit (Not evaluated by UL)

While armed in the Interior Mode, Easy Exit can be initiated by pressing  or . Easy Exit restarts the Exit delay, allowing a User to exit an armed premises without disarming and rearming the system. Disable  or  buttons as Easy Exit.

#### Easy Programming of Auto download ID #'s and PC Preset Callback # (GEM-RP1CAe2/GEM-K1CA only)

It is now possible to set the PC Preset Auto download ID # and PC Preset Callback phone number from the GEM-RP1CAe2/GEM-K1CA Easy Program Mode.

1. Enter Easy Program Mode and press PRIOR/NO until Central Phone # is displayed.
2. Program an "F" followed by the Auto Download ID # (2 digits) and then the Callback Telco # (up to 13 digits).
3. Press  to save.
4. Exit Program Mode ([RESET] [RESET]).
5. Enter Function Mode
6. Go to Function "ACTIVATE DOWNLOAD Y/N" and press NEXT/YES.
7. The panel will automatically call the PCPreset computer and download the program on the specified Auto DL line #.

**Note:** After the auto download of the control panel program, the system must be fully tested.

--See following example:

**Enable Alarm Output on Telco Fail only when Area(s) Armed (Alarm Output Only when Armed)**

Example: Program an Auto Download ID # of 07 and a PC Preset Callback # of 1-516-842-9400

- Go to Central Phone # input screen and press: [\*] [5] [0] [7] [1] [5] [1] [6] [8] [4] [2] [9] [4] [0] [0] [ON/OFF]  
'F' Auto DL ID# Callback Phone # Save

Allow Telephone Line Fault test to produce an Alarm Output only when armed. **Note:** requires "System Features: Alarm Output", "Telco Fail" and version 9 or later panel.

**Enable CP-01 Egress Tones Only:** Enable this feature if you want exit and entry sounds only--without setting any other CP-01 features. When enabled, the Exit Delay keypad sounder (including the Exit Urgency sound during the final 10 seconds of the Exit Delay) is enabled.

**Enable CP-01 Limits**

When enabled, three time limits are enabled as per the SIA CP-01 standards: (1) Exit Delay Time: If an attempt is made to change the Exit Delay time to less than 45 seconds the time will be entered as 60 seconds. The maximum programmable time is 255 seconds; (2) Entry Delay: If an attempt is made to change the Entry Delay time to less than 30 seconds the time will be entered as 30 seconds. The maximum programmable time is 255 seconds; and (3) Abort Delay: If an attempt is made to change the Abort Delay to less than 15 seconds or more than 45 seconds the time will be entered as 30 seconds.

**Note:** In accordance with UL standards, the aggregate of the Entry Delay time and Abort Delay time "window" will not be programmed to exceed one minute. **Note:** When "Enable CP-01 Limits" is enabled, the Exit Delay keypad sounder (including the Exit Urgency sound during the final 10 seconds of the Exit Delay) is enabled. **Note:** If "Enable CP-01 Limits" is enabled in EZ Programming, any Zone in a Group *will only activate an alarm and send a report ONCE.* After the Zone has reported, it will remain in the Group and may still initiate the Zone ANDing sequence.

**Enable Keypad 1 Only Programming:** In version 01 of the GEM-P1664 panel, programming is allowed from any keypad by default. Program to restrict programming to Keypad #1 only, if needed.

**Enable Local Alarm on First Zone "AND" Trip** See Zone ANDing (Do not program in UL installations)

**Enable TCP/IP Communications**

Using the NetLink NL-MOD TCP/IP communications module accessory, the GEM-P1664 can report alarms via contact closures or via its bell output but cannot report alarm data such as point ID information. The panel can, when the NL-MOD is visible on a network, receive Windows Quickloader programming information or transmit panel log information over the network. Refer to the NL-Mod Installation Instructions WI1242 for more information.

**Enable Telephone Line Fault Test**

Enable Line Fault Test will cause the panel to monitor the phone line. A failure will display as "SYSTEM TROUBLE/E-08 SERVICE" for Telco Line Fail. Program this system trouble to activate the Burglary Output.

**Enable 2-Count Swinger Shutdown** See Swinger Shutdown

**Exit/Entry Delay; Exit/Entry 1; Exit/Entry 2; Entry Relay**

Delays permit exit and entry through the Entry/Exit Zone(s) after the system is armed without setting off an immediate alarm. Entry delay allows the user time to enter and disarm the panel. Exit delay allows the user to leave the premises after the panel has been armed. Unless the keypad has been configured otherwise, the sounder will come on and will pulse during the last 10 seconds of entry delay to remind the user to disarm.

Two individually-programmable entry-delay times are provided to accommodate different entry zones. If two or more Exit/Entry Zones are entered in succession, the delay programmed for the last Exit/Entry Zone entered will take precedence over all others. Exit-Delay time and Entry-Delay time may each be programmed for up to 255 seconds (4 minutes). See Time Selection.

An external relay may be programmed to trip upon entry (see Programming Manual: Relay Event ID Codes, Area Entry Relays), and remain on for a programmed duration.

**Note:** In UL installations, maximum exit delay is 60 seconds; maximum entry delay is 45 seconds. In UL Mercantile installations, maximum entry delay is 60 seconds.

Entry delay may be canceled by pressing the  button prior to arming, however it will be restored automatically upon disarming.

**Exit/Entry Follower**

A zone programmed as an Exit/Entry Follower will ignore detection during the exit delay, and only during entry delay if the Exit/Entry Zone is entered first. Thus, detection devices (passive infrared detectors, for example) along the path between the keypad and the exit/entry door will not signal an alarm during exit/entry delay under normal conditions. However, if a device in the Exit/Entry Follower Zone detects a violation when the exit/entry door has not first been entered, there will be no entry delay and the Exit/Entry Follower

Zone will go into an instant alarm. If the panel is armed with the entry delays canceled (Instant protection), any violation on the Exit/Entry Zone or the Exit/Entry Follower Zone will cause an immediate alarm.

### Exit Time Restart

This option allows for the following scenario prior to the end of the Exit Time: a violation of an entry/exit zone, a restore, and a second violation of an entry/exit zone *restarts the Exit Time*. The panel does not allow the Exit Time to be restarted more than once. The default setting for this option is *enabled*.



### Expansion Module Zones; EZM Type; EZM Tamper See Tamper

Zones 9–64 or 17-64 (with "Zone Doubling" enabled) are expansion zones added to the basic system using expansion zone modules (EZMs). Any combination of GEM-EZM8 (8 zones) and/or the 4-zone EZM modules integral to each GEM-RP1CAe2 keypad may be used. Refer to the instructions accompanying each module for wiring information.

Each GEM-EZM4/8 Zone Expansion Module has series zone doubling and supervision capability. When an EZM is selected for zone doubling, the EZM will respond as EZM 1 (zones 17 to 24) or EZM 3 (zones 25 to 32) when polled. (Refer to GEM-EZM4/8 Installation Instructions). The EZM zone doubling or loop supervision functionality can be set to either follow the panel configuration or to act as a standard non-zone doubled EZM. Program (see Programming Instructions) to enable all EZM's to follow the attributes of the control panel (global panel feature). **Note:** A GEM-EZM8 cannot be used if the panel is set for loop supervision or zone doubling and this feature is enabled.

Regardless of how the modules are arranged, the expansion zones are divided into consecutively-numbered groups of four. Each 8-zone module comprises two groups. Each group is assigned a number.

### EZ Arming (Easy Arming); Easy Arming Closing Report





Permits quick arming by simply pressing the  button for "Classic" RP Style keypads. Each keypad may be individually programmed for Easy Arming (see Keypad Features). Disarming still requires entry of a valid user code. **NOTE:** Do not program in UL installations. If closings are reported, Easy Arming will report as User 67. Press and hold  or  to EZ Arm "K Series" keypads.

### EZ Zone Doubling

The control panel zone configuration may be expanded from 8 to 16 zones without the use of EZM Modules. To do so simply select "Zone Doubling" and connect zones as shown in Wiring Diagram. The 3.9K EOL resistor must be placed at the end of the loop of the higher zone. For proper supervision, the 2.2K EOL resistor must be placed at the end of the loop of the lower zone.

**Note:** If Zone Doubling is to be used, then normally closed devices must be wired to both zones. If Normally open zones for fire or panic devices are required, then the lower zone (2.2K EOL resistor) must be used and the higher zone (3.9K EOL resistor) must not be programmed for any area.

### Fire; Keypad Fire

Any zone may be programmed for Fire. Connect normally-open devices across a Fire Zone. (The EOL2.2K end-of-line resistor must be installed). A short across the zone will cause a fire alarm, which will be indicated at the keypad by a "FIRE ALARM" LCD display and pulsing sounder. An open circuit on the Fire Zone will identify a trouble and cause flashing "SYSTEM TROUBLE/E4-00 SERVICE" LCD display and pulsing sounder after a 10-second delay. The sounder may be silenced by pressing the  button. The LED will go off within 30 seconds after reset if the alarm or trouble is cleared. For Smoke-Detector Reset, see Alarm Outputs. Fire or Keypad Fire can be made to trip an alarm or report to Central Station. If Keypad Fire is programmed, pressing both the  and  buttons at the same time will sound a fire panic alarm and display "FIRE ALARM" at the keypad. The Keypad Fire function is supplementary to the hardwired zones. **Note:** This feature shall not be considered a substitute for listed manual initiating devices. A fire condition that has not been restored will cause the zone number and description to scroll. To reset (acknowledge) the condition, enter a valid code, then press the  button.

### Fire Verification (Not for use in California)

An alarm on any Fire Zone programmed for "Fire Verification" and connected to the fire power terminal will cause all fire zones to be powered down for 12 seconds. (All devices must be wired with + power on Terminal 25). After this time, power is restored and a 4-second power-up time is started. Thereafter, the zone will be active again. This represents a total processing delay of 16 seconds from the time the alarm is first detected. If an alarm condition still exists at this time or reoccurs within 2 minutes, an alarm will be initiated, otherwise the zone will return to its original state. **Note:** A zone programmed for "Fire Verification" must be programmed as a "Fire Zone" as well.

### GEM-Print

A printer can be made to print all logged operations directly from the panel, when programmed for "Enable GEM-PRINT Module" and a separate Gem-Print Module is added to the panel.

**Include Selective Bypass In Conditional Closing/Status See Closing Report.**



**Inhibit System Trouble Audible at Keypad** (Do not program in UL installations)

For installations where an audible during a system trouble is not desired, an option, *Inhibit System Trouble Audible* can be enabled. Regardless of the system status (Armed or Disarmed) there is no keypad sounder in the event of a system trouble. However, the trouble will still scroll in the keypad display until [RESET] is pressed and the SYS TBL icon will display until the trouble is restored.

- To disable System Trouble Audible, enable the option *Disable System Trouble Audible* in the QL-Windows Keypad Features screen.

**Interior Stay Zones; Interior Normally Bypassed (Stay Mode); Auto Interior Bypass (Stay)/Easy Exit**

Removal of a programmed group of interior (Stay) zones from the system will permit freedom of movement throughout the premises but still allow protection from intrusion through armed perimeter zones. Pressing **INTERIOR** prior to arming will select the Interior Zones, then arm to bypass. The next time the control panel is disarmed, all bypassed zones will automatically revert to non-bypassed (disarmed) zones. When **INTERIOR** is pressed, the "BYPASS" reminder will come on.

The bypassed zones may be displayed on the keypad (see GEM-RP1CAe2 FUNCTION MODE).

If Interior Normally Bypassed is selected, all Interior (Stay) zones will always be inactive. The "BYPASS" reminder will always display, indicating that only partial protection will be provided upon arming. To temporarily restore interior protection, press **INTERIOR**; the "BYPASS" reminder will go out upon arming, denoting full protection, however Interior (Stay) Zones will once again be bypassed the next time the panel is disarmed.

If "Auto Interior Bypass/Easy Exit" is programmed, all Interior Zones will automatically be bypassed if the Exit/Entry doors are not opened during exit delay. If **EXIT** is pressed while armed with Interior Bypassed (Stay), exit delay will restart and Exit/Entry doors may be opened to permit someone to exit (while others remain on premises) without causing an alarm.

**Interior (STAY) Bypass**

Interior Zones, when bypassed, allow free movement within the home while the protection of armed perimeter zones is maintained. To bypass Interior Zones, enter your User Code and press **STAY**. All zones (including Interior Bypass Zones) are all protected with full protection, in ARMED AWAY mode.

**Jumpers** (Refer to Wiring Diagram for UL configuration)

JP1: Keypad Configuration Jumper (top center) is installed across top and center pins for normal operation. When configuring GEM-RP1CAe2 and GEM-K1CA keypads, move jumper across center and lower pins.

JP3: 2-Wire Fire jumpers. Select Zones 7 and/or 8 for use as either 2-Wire Fire Zones or Burglary Zones.

**KeyFob Control of Relay Groups 1 and 2**

The GEM-P1664 supports KeyFob Control of Relay groups 1 and 2. The KeyFob Aux 1 and Aux 2 buttons can be programmed to toggle on and off external Relay Groups 1 and 2.

**KeyFob Arm/Disarm chirp of Alarm Output.**

The Key Fob Arm/Disarm chirp can be directed to the Alarm Output, which can free up the PGM2 Output for other uses such as garage door opener control. To enable the Key Fob Arm/Disarm chirp option on Alarm Output, enable 'Chirp' Output on KeyFob Arm/Disarm and Select Alarm Output for KeyFob 'Chirp' in the PCD-Windows Options screen.

**Keyfob Transmitters; Chirp Output on Keyfob; Select Alarm for Keyfob Chirp**

Keyfob transmitters can (1) operate up to four zones, or (2) can Arm/Disarm an area and provide two Auxiliary control buttons, but cannot be operated in these two modes simultaneously. A Keyfob Transmitter set up to Arm/Disarm an area with "PGM2 Chirp on Keyfob Arm/Disarm" will cause a 1chirp sound on arming and a 2 chirp sound on disarming, by using an steady state Alarm Output (not a Pulse Alarm, Cadence Pulse Alarm or Voice Siren Driver). Programming the Auxiliary Keyfob Buttons to "C: PGM2 Output Toggle" on Auxiliary 1 or 2 buttons will cause PGM2 to toggle the current condition of the PGM2 output. Keyfob 1-8 can have their opening / closings reported as users 57 through 64, respectively.

**Keypad Area Assignments**

In multiple-area systems, each keypad must be individually configured to the correct keypad number. No two keypads can possess the same keypad number. No keypad numbers can be skipped (they must be contiguous). Note that each address comprises 2 nibbles; enter the Area Number in the right nibble.

**Keypad Digital Dialer Test**

A Digital Dialer Test (Central Station Comm. Test) can be initiated from the function menu. Press **MENU** until "DIGITAL DIALER TEST Y/N" is displayed and then press [NEXT/YES] to initiate the transmission of a Test Timer signal. **Note:** Test Timer reporting codes and *Report Test Timer on Telco1 or Telco 3* must be programmed.

**Keypad Jumpers (GEM-RP1CAe2 / GEM-K1CA)**

Refer to label LA1374 on the circuit board fishpaper for jumper locations and a summary of settings.



JP1: Cut to enable Keypad Tamper.  
 JP3: Note different zone terminal wiring required as shown in wiring diagram.  
 W1 & W3: Cut both to disable touch pad backlighting.  
 W2: Cut to disable LCD backlighting.

#### Keypad Jumpers (GEM-RP2ASe2 / GEM-K2AS)

Refer to label LA1390 on the circuit board fishpaper for jumper locations and a summary of settings. See Section 3: Configuring the GEM-RP2ASe2 Keypad for jumper selection.

#### Keypad Jumpers (GEM-RP3DGTL / GEM-K3DGTL)

Refer to label LA2090 on the circuit board fishpaper for jumper locations and a summary of settings. See Section 3: Configuring the GEM-RP2ASe2 Keypad for jumper selection.

#### Keypad Jumpers (GEM-RP4 Series / GEM-K4 Series)

Refer to label LA2103 on the circuit board fishpaper for jumper locations and a summary of settings. See Section 3: Configuring the GEM-RP2ASe2 Keypad for jumper selection.

#### Keypad Features

The following programmed system features will activate only if they have also been enabled at the keypad.

- Ambush
- Easy Arming
- Access Control
- Keypad (Police) Panic
- Keypad Auxiliary Panic
- Keypad Fire Panic

#### Keypad: GEM-K Series Keypads

Panel automatically detects the difference between the "Classic" and the K-Series ("STAY" and "AWAY") style keypads. Keypad #1 will determine this keypad type for the panel.

**Keypad Panic** See Panic Zone

#### Keypad Sounder on Alarm

If a programmed zone goes into alarm, the keypad sounder will activate and will remain activated until the **RESET** button is pressed or the system is disarmed.

**Keypad Tamper** See Tamper

#### Keypad Zone Directory

The GEM-RP1CAe2/GEM-K1 keypads will support the display of the Keypad Zone Directory. Press **FUNCTION** or **MENU** until "DISPLAY ZN DIRECTORY Y/N" is displayed and press [NEXT/YES]. Scroll through the zone directory by pressing [NEXT/YES] / [PRIOR/NO].

#### Keyswitch Arming; Maintained-Key Input Arming

The area will arm/disarm when the programmed zone is momentarily shorted (momentary keyswitch). To supervise the keyswitch, program the zone for Day Zone on Open. Keyswitch Arming will be reported as User 68. Keyswitch must be provided with EOL resistor. Maintained-key input arming will arm when shorted and disarm when opened.

#### Line-Reversal Module, M278

The Line-Reversal Module allows the panel to be monitored by a central station through leased lines. On alarm, the module reverses normal line-voltage polarity. For details, refer to the instructions furnished with the module.

**Loop Response** See Zone Response Time

#### Low Battery; Wireless Low Battery; Keyfob Low Battery

A low-battery system trouble will annunciate at the keypad when the battery terminal voltage drops below normal. This condition may signal a local sounding device, report to a central station (program Panel Low Bat Report Code), or both. If a battery is installed and low terminal voltage is detected, a restore will not occur until the battery is recharged to its specified level and passes a dynamic test. The dynamic test may be initiated manually by pressing the **RESET** button, or it will be initiated automatically, every four hours, by the panel. In wireless installations, when displaying RF transmitter status, a "LoBatt" indication denotes a low-battery condition at the transmitter.

**Lug E15** See "E" Lugs

### Memory Failure

A User or Dealer Memory error will cause the sounder to pulse, the "SYS/TRBL" reminder to flash, and the display to read "SYSTEM TROUBLE/E19-00 SERVICE" or "SYSTEM TROUBLE/E20-00 SERVICE". Press the **RESET** button to silence the sounder ("SYSTEM READY" will display, along with the "SYS/TRBL" reminder). Activate RESET SYSTEM TROUBLE to manually reset the system trouble. A Memory Failure can be programmed to activate an alarm output and/or report using its associated system Report Code.

### Never Arm (Do not use for primary Burglary protection)

A zone programmed as "Never Arm" cannot go into alarm. If tripped, it will display at the keypad when the DISPLAY STATUS function is selected. A chime will sound at the keypad while armed or disarmed if Chime is also programmed for that zone, and enabled at the keypad. This feature is suggested for use as a garage-door or driveway monitor, or similar application.

### No EOL Resistor

Program for any zone not wired with a 2200 Ohm end-of-line resistor. This will disable any zone-short indication (if programmed, "Day Zone Short" is disabled). If not programmed, an end-of-line resistor must be installed. **Note:** This selection is automatically disabled for zones selected as Fire. **Note:** Do not program for UL installations.

**Number of Rings Before Pickup (Answer on Ring)** See Callback-Method Download

**One-Button Arming** See Easy Arming

**Opening Report; Opening Report Only After Alarm Report** (Do not program for UL installations).

Opening and closing reports are generally used in commercial installations. On disarming, the communicator can send an Opening Code for Users 1–64 (Opening Report), or it may transmit only when the control panel is disarmed after an alarm has been reported (Opening Report Only After Alarm Report). (**Note:** Key Fobs 1–8 report as Users 57–64). Subscriber Identification Numbers and Opening Codes must be entered for either opening report.

Program Opening Report Only After Alarm Report to report only when disarming after an alarm report. This feature may be used by the central station to verify that the subscriber has responded and disarmed the panel. If "Opening Report Only After Alarm Report" is selected, also select "Opening Report" for each user.

**Panics; Keypad Aux Panic; Keypad (Police) Panic; Keypad Fire Panic** See Fire; Remote Panic

The Panic Zone is always a 24-Hour Zone. Each keypad is individually selectable for keypad panics (see Keypad Features). If "Keypad Panic" is programmed for a keypad, police panic is activated by simultaneously pressing the **9P** and **\*** buttons. If "Keypad Aux." is programmed, pressing the **8A** and **\*** buttons simultaneously will trip an auxiliary emergency alarm. If "Keypad Fire" is programmed, pressing the **7F** and **\*** buttons at the same time will activate fire panic.

A remote panic button may be connected to a GEM-RP2ASe2/K2AS and GEM-RP3DGTL/K3DGTL Keypad. Splice the two white wires from the keypad to a normally-open momentary-contact pushbutton. Additional panic buttons may be wired in parallel with the first. If remote panic will not be used, insulate both white wires, as a short across them will cause a panic alarm. (In UL installations, remote-panic buttons must be located within 3 feet of the keypad, with no intervening walls or barriers.)

### Power-Up Delay

If programmed, power-up will be delayed for 5 minutes to allow devices such as PIRs time to stabilize (warm up). This will prevent false alarms when ac power is restored after a long power outage and the backup battery is discharged. SIA CP-01 requires you must program this feature on all zones with sensors.

**Pre-Alarm Warning** (Not for UL installations)

Programmable by zone, this feature will cause an alarm to sound only at the keypad for the duration of the programmed Abort Delay (see Abort Delay; Time Selection). After the delay has elapsed, the alarm output will activate and a report will be sent. On a system containing both interior and perimeter zones, the Pre-Alarm Warning will be active ONLY while the system is armed Stay (interior zones bypassed). Tripping the perimeter zones activates an audible keypad warning before the alarm. If armed Away, ALL pre-Alarm warning zones will cause an immediate alarm if tripped. Entry/Exit zones should not have Pre-Alarm Warning programmed. On systems with perimeter zones only, the pre-alarm warning will always be active when the system is armed. To enable, select *Pre-Alarm Warning* in Zone features and provide an Abort Delay Time of 0 to 254 seconds. Zero defaults to 10 seconds.

### Pre-Dial Delay

A Pre-Dial Delay may be used whenever a delay is required before dialing. It may be required when programming Dial-Tone Detection, which causes the communicator to wait before it attempts to detect a dial tone (see Dial-Tone Detection). Certain telephone exchanges send a nonstandard dial tone that the communicator may not be able to detect. With these nonstandard exchanges, it is possible to program Pre-Dial Delay rather than Dial-Tone Detection. This will cause the communicator to wait for a 4 second time period before dialing. Contact the telephone-equipment supplier to find out how long a delay is required before dialing. Select "Pre-Dial Delay" by programming one "D" for each 4-second delay required immediately before the telephone number. In UL



installations, do not program more than one "D" before the telephone number. See Backup Report on Telco 2; Report Telco 3 (Double or Split Reporting). Also see Access Number for Outside Line; Telephone Numbers.

**Print Module Support**

The bus mounted GEM-PRINT will print all system activity. If the GEM-PRINT fails, it will cause an E27- 00 Printer Fail system trouble.

**Priority Area Arming**



Prevents area arming if the alternate Priority Area has not yet been armed.

**Priority Zone (Required for all zones in UL installations)**

A zone that will prevent arming if faulted. If an attempt is made to arm, the sounder will come on and "ZONES NOT NORMAL / CAN'T ARM" will be displayed for 4 seconds. The keypad may be reset by simply pressing the **RESET** button. The fault on a Priority Zone must be corrected before the panel can be armed. Any zone may be selected as a Priority Zone. A zone in trouble that is neither a Priority Zone nor an Auto-Bypass Zone will cause an alarm on arming.

**Priority Zone with Bypass**

A Priority Zone that will permit arming if the priority condition is bypassed. If the system is so programmed, the zone will auto-bypass and (optional) the condition will be reported to a central station.

As above, if an attempt is made to arm, the sounder will come on and "ZONES NOT NORMAL / CAN'T ARM" will be displayed. To reset the keypad, press the **RESET** button; the display will read "ZONE FAULTS". To arm the panel, press the **BYPASS** button, then enter the zone number, then press the  or  button. Any zone not selected as a Priority Zone may be programmed as a Priority Zone with Bypass.

**Pulse Burglary Output** See Alarm Outputs

**Receiver Format**

The communicator can be programmed to transmit to any standard central-station receiver format. A receiver format must be entered for each telephone number used, but a different format may be assigned to each. Refer to Backup Report on Telco 2 and Report Telco 3 to determine whether or not Telephones 2 and/or 3 will be programmed. Call the central station for each telephone number used to confirm the type of receiver in use. Select the receiver format entry for each telephone number from the following table.

ENTRY	RECEIVER FORMAT	DATA FREQ. (Hz)	DUTY CYCLE (ON/OFF)	INTERDIGIT TIME
blank (+)	Ademco, Silent Knight Slow	1900	60/40mS	600mS
2	Radionics Fast	1850	13/12	400
3	Silent Knight Fast	1900	40/30	560
4	Radionics, DCI, Franklin Slow	1800	60/40	600
5	Universal Hi-Speed	1850	30/20	350
B	SIA*	Modem formats		
C	Ademco Point ID*			
E	Pager			

\*These formats do not use programmable codes, but Event ID Codes to identify the type of zone and alarm as follows:

- 1 – Fire
- 2 – Panic
- 3 – Burglary
- 4 – Holdup
- 7 – Gas Alarm
- 8 – Heat Alarm
- A – Auxiliary Alarm (keypad displays "0")
- B – 24-Hour Auxiliary Alarm

**Relay Control (Optional External Relays)**

In addition to the three relay outputs (Alarm, PGM1 and PGM2) provided on the motherboard, up to 16 external relays can be controlled from the keypad through the use of the RM3008 (self-contained) or the RB3008 (to be mounted inside housing). The GEM-OUT8 is similar to the RM3008 but has open collector active low outputs in place of relays. The GEM-OUT8 is designed for



external remote mounting, and one module may be used with the GEM-P1664 Control Panel. Use the RM3008, RB3008 or the GEM-OUT8 for 16 independent programmable active low outputs for controlling 32 relay events, which can be assigned to any of the 16 available external outputs. Multiple relay events can drive the same external relay.

### Relay Follows Zone

External Relays can be programmed to follow a zone. If values are entered in Time locations, the relay will time out after the programmed time.

**Remote Panic** See Panic Zone

### Report Digital Dialer Exit Error/Recent Closing

A Recent Closing transmission is sent if an alarm occurs within two (2) minutes after the expiration of the Exit Time. If the user number is available, it is included in the Recent Closing transmission. **Note:** Recent Closing transmissions are not sent for fire alarms.

### Report Telco 1; Report Telco 3 (Double or Split Reporting)

Alarms, alarm restores, troubles and trouble restores may be selected individually for each zone. Violation of a zone selected to report will communicate the code(s) selected for that zone to the central station.

Normally, Report Telco 1 is used to report to the central station. Report Telco 3 is used when certain zones will report to a different receiver (split reporting); Report Telco 1 and Report Telco 3 are both used on the same zone to report to two receivers successively (Double Reporting). (Double Reporting requires a successful report to Telco 1 before reporting to Telco 3). Also see Backup Report on Telco 2.

**Reset Day Zone with Arm/Disarm Only** See Day Zone

### Residential Fire

Prevents battery depletion during alarm. Must be programmed in Residential Fire Installations.

### Security Bypass

Recommended for commercial applications, requires entry of a valid user code. A typical application would be a warehouse or shipping terminal where the overhead doors are programmed for 24 hour protection and must be Bypassed to allow access, and then Unbypassed again. To activate this feature, DO NOT program *Disable Code Required for EZ Bypass* is Program BE (Bypass Enable) for each user who is to have this ability.

To Security Bypass a zone:

1. Enter a code valid for bypass (Authority Level 1 or higher and Bypass option enabled), then press the **BYPASS** button; BYPASS ENABLED will display.
2. Press the **BYPASS** button, then the zone number (or vice versa) to deactivate that zone. Similarly, a bypassed zone may be unbypassed using the same procedure. **Note:** When the panel is subsequently disarmed, all bypassed zones revert to unbypassed zones (unless Disable Auto-Unbypass on Disarming is programmed or Interior Zones are programmed normally bypassed).

- It is not possible to Bypass/Unbypass Zones using the Directory Mode procedure.
- Typically, any zone, other than a fire zone, will automatically be unbypassed when the panel is disarmed.
- In order to unbypass a fire zone, follow procedures 1 through 4.
- When a fire zone is bypassed, the panel will go into a fire trouble condition. It will also transmit the fire trouble to the CS, if programmed to do so.
- Zones 1-9 are entered as 01 - 09.

### Select Alarm Output for Keyfob Chirp

This feature is associated with **Chirp Output on Keyfob Arm/Disarm**. Normally the chirp on a keyfob arm/disarm is transmitted to the PGM2 output. Selecting "Select Alarm Output for Keyfob Chirp" causes the "Bell" to chirp instead of the PGM2 upon remote arming.

### Selective Bypass

**Disable Code Required for EZ Bypass** (Not for UL installations)

Any or all zones (1-64) programmed for Selective Bypass may be removed from the system, but each must be removed separately. Refer to BYPASSING ZONES in Section 3 for operation. Security Bypass: Recommended for commercial applications, requires entry of a valid user code. EZ Bypass: Recommended for residential applications, is selected by programming Disable Code Entry for EZ Bypass; this will permit bypassing/unbypassing zones without the need of entering a code (see EZ Bypass in Section 3). Do not program this feature in high-security applications. When one or more zones is bypassed, the BYPASSED reminder on the GEM-RP1CAe2 and GEM-K1CA keypads will display.





**Sensor Watch**

It supervises designated zones for a lack of activity and will cause a system trouble E-22-XX Sensor Activity Fail if no activity is detected for the programmed period of time. The sensor watch should be determined based on the coverage area while disarmed and calculated using the least amount of traffic.

**Silencing Alarm Area**

In any system, the ability to silence any combination of alarm devices (outputs) initiated from any area. This must be programmed for all systems to be able to silence an alarm. For example, in a 4-area system, each area could be programmed to silence only those alarms initiated within its own area; or all areas could be programmed to silence an alarm initiated from either area.

**Silence All Outputs During Audio Session** See Veri-Phone™ Audio Priority Over Alarms

**Single-Digit Format** See Central Station Receiver Data Format

**Smoke Detectors; 2-Wire Smoke Detectors; Wireless Smoke Low Battery Resound**

Connect smoke detectors as shown in the diagrams. The "Fire Power" (Terminal 25) is used to reset the smoke detectors.

*Two-Wire Smoke Detectors*

Two-wire smoke detectors may be used only on Zones 7 and 8. Up to 10 compatible 2-wire smoke detectors may be wired to each zone. In Residential applications, program Pulse Alarm Output. Zones 7 and 8 have been designed so they can be easily configured as 2-wire smoke detector zones by means of jumpers (JP3) located above Terminal 21.

1. Program Zones 7 and/or 8 for 2-Wire Smoke Detectors and Fire.
2. If Zone 7 is selected as a 2-Wire Fire Zone, move the left jumper on JP3 from the top two pins (BURG) to the bottom two pins (2WF).
3. Similarly, if Zone 8 is selected as a 2-Wire Fire Zone, move the right jumper on JP3 from the top two pins (BURG) to the bottom two pins (2WF).
4. Connect 2-wire smoke detectors to Zones 7 and/or 8 as shown earlier in this manual.

*Four-Wire Smokes*

If installing 4-wire smokes, subtract smoke-detector alarm current from available standby current. See COMPATIBLE UL-LISTED DEVICES on page 8.

Wire 4-wire smokes as shown earlier in this manual. Program each zone for Fire. Also program zones for Pulse Alarm Output. If they are of the self-resetting type, 4-wire smokes may be powered from Terminals 25 and 6.

*Wireless Smokes*

Wireless Smoke Low Battery Resound allows smoke detectors to sound off every 4 hours to indicate low battery voltage and the need for replacement. (Required for UL installations)

**Sound Alarm On Exit Error**

An Exit Error sequence is initiated if an entry/exit zone is violated at the expiration of the Exit Time. An Exit Error is processed as follows:

1. The local alarm shall immediately sound.
2. The keypad annunciator sounds an Entry Delay.
3. An Entry Delay is initiated.
4. If the alarm system is not Disarmed at the end of the Entry Delay, the Alarm Transmission Sequence is initiated.
5. The Alarm Transmission includes the alarm and an Exit Error Report Code.

**Status Report** See Closing Report

**Subscriber ID Numbers (Account Number)**

If reporting openings and/or closings, program Subscriber Opening/Closing Identification Numbers for each area for each telephone number used. If reporting events, program Subscriber ID Numbers for each area for each telephone number used. Subscriber ID numbers must be programmed for each area and telephone number, even if all are the same. Start with the left-most location.

**Sum Check** See Data Format

**Suppress Bypass Icon When Armed**

Program to inhibit the LCD "BYPASS" display while armed.



**Swinger Shutdown:**

Swinger Shutdown is a common term used in the burglary alarm industry. It is a feature of an alarm panel that prevents multiple false alarms from being generated from faulty detectors (or wiring) by limiting the number of alarms a zone may report during a single arming period. NAPCO has this programmable-by-zone feature named *Swinger Shutdown*, and has been available on its panels for years. The SIA False Alarm Reduction standard CP-01 (to which the panel complies) requires the SIA definition of "swinger shutdown" on all non-fire zones. Our programmable feature allows three trips per arming period which is unacceptable in CP-01 installations. Therefore, to reduce confusion, the following defines both definitions of "Swinger Shutdown", namely (1) the **NAPCO Programming Feature** and (2) the **CP-01 Requirement**:

- **Swinger Shutdown (NAPCO Programming Feature):** Program a zone with this feature to allow only three alarms per arming period. *Auto-Reset* must also be programmed for the zone for this feature to work. **Enable 2 Count Swinger Shutdown:** Same as Swinger Shutdown (NAPCO Programming Feature) above, but enables **two** alarms per arming period instead of three.
- **Swinger Shutdown (CP-01 Requirement):** *To meet CP-01, all non-fire zones must not be programmed for Auto-Reset.* A zone not programmed for Auto-Reset will trip only one alarm per arming period. The panel leaves the factory with no zones programmed for Auto-Reset. If "Enable CP-01 Features" is selected in the Easy Programming menu, all non-fire zones will not be programmed for Auto-Reset.

**System Troubles (Global and Area); Wireless Low Battery; Wireless Supervisory**

System troubles may be programmed to report to any telephone number and/or activate any output. Also program Subscriber ID Numbers, Telephone Numbers, and Report Codes for each system trouble.

**Tamper; EZM Tamper; Keypad Tamper; RF Tamper; Wireless Tamper**

Removing the cover of an expansion zone module will cause the sounder to pulse and the "SYS/TRBL" reminder to flash. The keypad will display "SYSTEM TROUBLE/E13-NN SERVICE", where "NN" denotes the module number. Press the **RESET** button to silence the sounder ("SYSTEM ERROR" will display). Correct the problem, then select RESET SYSTEM TBL to manually reset the system trouble display. Removing a keypad from the wall causes a similar system trouble indication. The keypad will display "SYSTEM TROUBLE/E11-NN SERVICE", where "NN" denotes the keypad number. Press the **RESET** button to silence the sounder ("SYSTEM ERROR" will display).

To manually reset the system trouble, correct the problem then select RESET SYSTEM TBL.

**Note:** If either of the tamper conditions is not corrected within 5 minutes, the system trouble will again display at the keypad. A Tamper condition can be programmed to activate the burglary output and/or report using its associated system Report Code. In wireless installations, when displaying rf transmitter status, a "Tamper" indication denotes that the transmitter case is open. **Note:** The GEM-RP1CAe2/ GEM-K1CA tamper is enabled by cutting jumper JP1 in the keypad.

**TCP/IP Communications** See Enable TCP/IP Communications

**Telco Fail** See Enable Line-Fault Test

**Telco Line Test Delay** See Enable Telephone Line-Fault Test; Time Selection

**Telephone Numbers**

To report to a central station, Telephone Number 1 must be programmed. Telephone Number 2 is programmed for Backup Reporting; Telephone Number 3 is programmed for Double or Split Reporting by selecting "Report Event Telco 3" and "Report Restore Telco 3" in SYSTEM OPTIONS and ZONE OPTIONS.

Private telephone systems may require a Dial-Tone Detection "E" or Pre-Dial Delay "D", followed by an access number to obtain an outside line. (See Access Number for Outside Line).

It should be noted here that the telephone number need not actually start in the first location shown, and may not end in the last. Extra locations have been provided to allow for one or more prefix digits: a Pre-Dial Delay "D" or a Dial-Tone Detection "E". What is important is that the telephone number, with its associated Pre-Dial Delay, Access Number, and Dial-Tone Detection, be wholly contained within that group of locations, and that they be in their proper sequence. **Note:** In UL Installations, do not program more than one "D" before the telephone number.

**Temperature Display at Keypad:** (Not evaluated by UL)

See the GEM-P1664 Programming Instructions WI1422 or WI1423 for more information. The temperature is displayed instead of the date on line 2 of the GEM-RP1CAe2 keypad. The keypad will display from -22F to 140F (or -30C to 60C). Fahrenheit is the default setting, select Celsius by enabling address 1668 option 2. When this Temperature Display Option is enabled, Zone 6 becomes the input for the "Napco Temperature Sensor" module and Zone 6 of the panel becomes inoperative; if Zone Doubling is selected, zones 6, 14 will be inoperative.

Address 1668 option 3 enables Zone 6 to report a temperature problem. Address 1666 (options 1-7) set the lower limit temperature value and address 1667 (options 1-7) sets the upper limit temperature value (both values are set in binary). If the temperature detected by the panel is above or below these set limits, the panel will report an alarm on Zone 6. To function and report properly, Zone 6 must be selected as a reporting zone, 24hr zone in area 1 and auto-resettable. At both 1666 and 1667 addresses, option 8 is sets



positive or negative temperature. If the temperature of 0 degrees is required, "negative zero" (-0) degrees must be used (+0 or an empty location is not a valid temperature). To simulate the sensor module, a power supply can be connected to Zone 6 and set from .55v to 3.05v to display the whole temperature range. Temperature values are read and updated every 5 seconds. To report an outer limit temperature, the temperature must be out of limits for 2 seconds. To avoid false alarm reports, the limits have a threshold of 5 degrees in the software. Two new logs have been created for temperature out of limits and restore. If the  key is depressed and held down for 2 seconds, the date will display for 5 seconds.

**Test Timer; Cancel Next Test Timer Report on Any Report**

The test timer schedule is programmed via the Easy Program Menu and using Napco's Quickloader Software. If "Test Timer" is programmed, an automatic test report will be transmitted to the central station on the scheduled day(s) at the scheduled time. To report test timer, select Report Test Time to Telco 1 or 3 and program a report code. Program the Test Timer reporting time and day of the week. If "Cancel Next Test Timer Report on Any Report" is programmed, any report will cause the next test-timer transmission to be aborted, however subsequent test-timer transmissions will report as scheduled. Do not program this feature in UL installations.

**Timeout**

Specifies the length of time that an alarm, alert, or delay will remain active. See Time Selection.

**Time Selection**

The following times are programmable:

TIME(1)	UNITS	MAX. PROG. TIME
PGM2 OUTPUT TIMEOUT	MIN.	UNTIMED(2)
PGM2 OUTPUT ACCESS CONTROL TIME	SEC.	4 MIN., 15 SEC. (255 SEC.)
ALARM OUTPUT	MIN.	UNTIMED(1)(2)
PULSE-BURG OUTPUT	MIN.	UNTIMED(1)(2)
PGM1 OUTPUT	MIN.	UNTIMED(2)
ABORT DELAY	SEC.	4 MIN., 15 SEC. (255 SEC.)(3)
CHIME TIME	SEC.	63.25 SEC. (255 QTR-SEC.)(3)
AC-FAIL REPORT DELAY	10 MIN.	42 HR., 30 MIN. (2550 MIN.)
EXIT DELAY	SEC.	4 MIN., 15 SEC. (255 SEC.)(4)
ENTRY DELAY 1	SEC.	4 MIN., 15 SEC. (255 SEC.)(4)
ENTRY DELAY 2	SEC.	4 MIN., 15 SEC. (255 SEC.)(4)
SENSOR WATCH	HRS	254 HRS.
CANCEL WINDOW	MIN.	254 MIN.
ZONE INTEGRATION TIME	10 MILLISECONDS	2.55 SEC.
ZONE ANDING TIME	SEC.	255 SEC.

**Time and Date (Keypad) in Dealer Program Mode**

The Keypad Time and Date on the GEM-RP1CAe2/GEM-K1CA keypad may be set in Dealer Program Mode.

**Time and Date (Keypad) in User Program Mode**

When using a GEM-RP1CAe2/GEM-K1CA, the Time and Date may be set in the User Program Mode.

**Time and Date Message Option**

In the event of a complete power failure (AC and DC) and the loss of the system clock, when the system is re-powered, a message 'SET TIME / DATE' will be displayed on the GEM-RP1CAe2 keypad. The message will remain until the Time and Date have been re-programmed.

**Touch-tone Dialing Only; TouchTone Dialing with Rotary Backup**

Select "TouchTone Dialing Only" if the subscriber has TouchTone service. TouchTone dialing is faster than rotary dialing, but not always as reliable.

For the communicator to use TouchTone on all dial attempts, program TouchTone Dialing Only. To use TouchTone on the first attempt with subsequent Rotary dial, program TouchTone Dialing with Rotary Backup. TouchTone Dialing Only will override TouchTone Dialing with Rotary Backup if both are selected. Note that if Backup Reporting is also selected, the communicator will alternate between TouchTone and rotary dial to reach Telephone 1, then Telephone 2. See Backup Report on Telco 2.

**Trouble; Fire Trouble**

An abnormal zone condition (a break in a normally-closed loop; a short on a normally-open loop; or either on an end-of-line-resistor supervised loop) when disarmed.

Trouble on a Burglary Zone is automatically displayed at the keypad unless Disable Zone Fault Scrolling is programmed. If a Burglary Zone is in trouble, it will go into alarm about 10 seconds after arming. However, if Auto Bypass is programmed, the keypad will beep upon arming (does not apply to selective- or group-bypassed zones).



Trouble (open and/or short circuit) on a Day Zone is indicated by a pulsing sounder; display the Day Zone(s) in trouble on the LCD. Keypad indications are reset by the **RESET** button unless Reset Day Zone With Arm/Disarm is selected.

Trouble on a Fire Zone will be indicated by the "FIRE/TRBL" reminder and the sounder. An open circuit (trouble) will cause a flashing "SYSTEM TROUBLE/E41-00 SERVICE" display and a pulsing sounder after a 15-second delay. (A short circuit will cause an alarm condition: steady-on "FIRE ALARM" display and pulsing sounder). The **RESET** button will silence the sounder. Clear the trouble, then press the **RESET** button once again. The keypad will reset after a brief delay.

#### **Trouble on Open; Trouble on Short** (Not for UL installations)

Trouble on Open will identify an open circuit on a loop as a trouble. Trouble on Short will identify a short circuit as a trouble. While there will be no indication at the keypad, any of these trouble conditions can be reported if Report Trouble is programmed as well. **Note:** For use on Burg type Zones only, not for use with 24-Hour Protection feature.

**Trouble/Trouble Restore Telco 1/Telco 3** See Report Telco 1/Telco 3

**Trouble/Trouble Restore Telco 2** See Backup Report on Telco 2

**Two-Digit Format** See Data Format

**Two-Wire Smoke Detectors** See Smoke Detectors

#### **User Codes/Area 1-4 Options; User Closing and Opening Reports by Telephone Numbers; Enable User Code by Area**

Up to 64 six-digit User Codes are programmable, each with its dedicated Area 1 through Area 4 Options. (Disabled, Arm/Disarm, Arm Only, Service, Access, Ambush, User Program and Bypass Enable). Refer to Easy Menu Driven Program Mode. If reporting to a central station, program User Closing and Opening Reports by Telephone Numbers. **Note:** An Ambush Code should not contain digits used as the first two digits of any user code. **Note:** Duplicate User Codes are not allowed.

#### **Veri-Phone™ Audio Priority Over Alarms; Veri-Phone Zones Trip PGM2 Output**

If Silence All Outputs During Audio Session is selected, all output relays will turn off whenever an active low is applied to control-panel Lug E19 (Listen In). Connect Veri-Phone Terminal 16 (INHO) to Lug E19. **Note:** Do not program Keypad Sounder on Alarm for Listen-In Zones.

If "Veri-Phone Audio Priority Over Alarms" is programmed and an active low is applied to the panel's Listen-In Lug (E19), any subsequent alarm reports (except fire alarms) generated during an audio session will be delayed until the end of the session. (Whenever a listen-in session is in progress, the Veri-Phone will output an active low at its INHO Terminal (16) and Lug E1).

Program "Veri-Phone Zones Trip PGM2 Output" to have selectable Listen-In Zones. Connect Veri-Phone Terminal 13 (TRIGL) to control-panel Terminal 8 (PGM2). Program the zone or event for PGM2. Do not use the PGM2 for any other purpose.

#### **Zone ANDing, Groups 1–4 (Not for UL installations); Enable Local Alarm on First Zone "AND" Trip (Not for UL installations)**

Up to four groups of at least two zones each can be "AND"ed, wherein the system will go into alarm only if any two zones of the group are tripped within a factory default time of one minute (but adjustable from 1 to 255 seconds via "Zone ANDing Time Window"). This feature is designed to afford redundant protection for devices, such as glass break detectors, PIRs, etc., that may show a tendency to false under certain conditions. Program each Group for any number of Zones available. All Zones in any Group must be within the same Area. Do not mix 24-Hour Zones and non-24-Hour Zones within the same Group. Do not include a Panic Zone as part of any Group. Auto-Reset must be programmed for each Zone ANDing Zone. **Note:** Any zone that is bypassed or goes into Swinger Shutdown will automatically disable Zone Anding for the entire Group. If "Enable Local Alarm on First Zone AND Trip" is programmed, a trip on any Zone of the Group will cause an alarm output and alarm display at the keypad; there will be no communication to the central station. **Note:** If "Enable CP-01 Limits" is enabled in EZ Programming, any Zone in a Group *will only activate an alarm and send a report ONCE*. After the Zone has reported, it will remain in the Group and may still initiate the Zone ANDing sequence.

**Zone Area 1–4** See Areas

**Zone Number on Pulse Alarm** See Data Formats: Two-Digit Format

#### **Zone Response Time** (750mS required for UL installations)

Loop response is the amount of time in milliseconds (mS) that a normally-closed circuit must remain open, or a normally-open circuit must remain closed, to trigger an alarm. The slower the loop response, the more immune the system will be to intermittents ("swingers"). Loop response times for Zones 1 through 8 are programmed into the control panel; Zones 9-16 with "Zone Doubling" enabled have loop responses the same as their respective 1-8 zones; those for Zones 9 through 64 loop responses are selected in the respective keypad configuration mode or expansion zone module jumper. The panel Zone Response time can be adjusted to a new global value. Address 2062 accepts three decimal digits which are multiplied by 10 milli-seconds to get a new value that replaces the default value of 750ms. If the location is set to 000 the system will default to 750ms internally. The maximum value is 255. If a value above



255 is entered the system will display 000 to request a re-entry. **Note:** Only the panel zones' integration times are programmable. EZM's will continue to use either 50 or 750 ms as selected by jumpers on the EZM. In addition, zone responses are enabled only when armed.

Selectable loop-response times for Zones 1–8 are:

- 750mS (.75 sec.): The slowest loop-response time, recommended for use with magnetic contacts, window foil, etc. Unless programmed otherwise, loop-response time will be 750mS for all zones.
- 50mS (.05 sec.): Used for momentary Panic Buttons and area-protection devices, such as photoelectric eyes, passive infrared sensors, floor mats, etc.

### Zone Status

In high security installations where Disable Auto Status has been programmed, enter the User code and press **FUNCTION** or **MENU** until "Display Zone Status Y/N" is displayed. Press NEXT/YES and then NEXT/PRIOR to scroll through any faulted zones.

**Zone Type** See Central Station Receiver Data Formats: Modem Formats

**2-Wire, 4-Wire Smoke Detectors** See Smoke Detectors

### 24-Hour Zone

A zone selected for "24-Hour Zone" that provides protection at all times, whether or not the system is armed. If "Alarm Output", "Pulsed Alarm Output", "PGM1 Output", "PGM2 Output" and "Keypad Sounder on Alarm" are **not** selected, then the zone is programmed for silent alarm. In this case, there will be no indication on the keypad if the zone is tripped. A 24-Hour Zone will be reset when the zone fault has been cleared and the area has been armed and disarmed. **Note:** Do not program a Day Zone as a 24-Hour Zone.

**24 Hour Day Zone Trouble**--Normally used for a hidden N/C panic button that when pressed, trips an alarm. Switch open = alarm. Short or cut in the loop = trouble.



# STANDBY-BATTERY CALCULATION WORKSHEET

Use the procedure given below to determine the required standby battery capacity in Ampere-Hours (AH). NOTE: It is not totally accurate to merely multiply the combined standby current (in amperes) by the standby time (in hours) to obtain the battery capacity (in ampere-hours), since other factors (control-panel charging capabilities, temperature, battery condition, etc.) affect battery operation. The following calculations will yield the theoretical minimum required capacity.

## 1. STANDBY CURRENT

DEVICE	QTY		STANDBY CURRENT (Amps)		
			EACH	=	TOTAL
GEM-P1664	1	X	0.120	=	0.120
GEM-EZM4/8		X	0.050	=	
GEM-EZM8		X	0.050	=	
GEM-RP1CAe2/ GEM-K1CA		X	0.100	=	
GEM-RP1CAe2/ GEM-K1CA <sup>(1)</sup>		X	0.035	=	
GEM-RP2ASe2/ GEM-K2AS		X	0.065	=	
GEM-RP2ASe2/ GEM-K2AS <sup>(2)</sup>		X	0.020	=	
GEM-RP3DGTL/ GEM-K3DGTL		X	0.050	=	
RM3008 <sup>(3)</sup>		X	0.040	=	
GEM-K4 / K4RF		X	0.045 / 0.075	=	
		X		=	
<b>TOTAL STANDBY CURRENT</b> →					<b>Amperes</b>

(Box 1)

$$X \text{ [Box] Hours} = \text{[Box] AH.}$$

(Standby Time)<sup>(4)</sup> (Box 2)

<sup>(1)</sup> Backlighting disabled (cut Jumpers W1, W2 & W3).

<sup>(2)</sup> Backlighting disabled (cut Jumpers A, B & C).

<sup>(4)</sup> Standby Time in Hours.

## 2. ALARM CURRENT

DEVICE	QTY		ALARM CURRENT (Amps)		
			EACH	=	TOTAL
<b>TOTAL STANDBY CURRENT</b> (from Box 1, above) →					
GEM-P1664 <sup>(1)</sup>	1	X	0.100	=	0.100
BELLS		X		=	
STROBES		X		=	
HORNS / STROBES		X		=	
		X		=	
		X		=	
<b>TOTAL ALARM CURRENT</b> →					<b>Amperes</b>

$$X \text{ [Box] Hours} = \text{[Box] AH.}$$

(Alarm Time)<sup>(2)</sup> (Box 3)

<sup>(1)</sup> Alarm current drawn in alarm.

<sup>(2)</sup> Alarm Time in Hours. Example: For a 15 minute alarm timeout, Alarm Time = 15/60 = 0.25.

**MINIMUM REQUIRED BATTERY CAPACITY = BOX 2 + BOX** → **Amperes**

# WIRING LEGEND

Should removal of the circuit board be necessary, use this wiring legend to relocate wire leads to their proper terminals. Enter wire identification number or color code in WIRE NUMBER column and enter wire function in DESCRIPTION column (optional).

TERMINAL	WIRE NO.	DESCRIPTION
1		
2		
3		
4		
5		
6		
7		
8		
9		
10		
11		
12		
13		
14		
15		
16		
17		
18		
19		
20		
21		
22		
23		
24		
25		
26		
27		
28		
29		

Wiring Legend



# KEYPAD PROGRAMMING MODES

**Note:**

- Functions that are not active, not programmed and/or not applicable to user's area option will be suppressed and will not display.
- Due to space constraints, GEM-RP2AS/RP2ASe/RP2ASe2/K2AS messages are abbreviated.
- Many functions will not be displayed (such as: "DISPLAY ZN FAULTS"). It will require a faulted zone to display or the required condition to be present.

## FUNCTION MODE

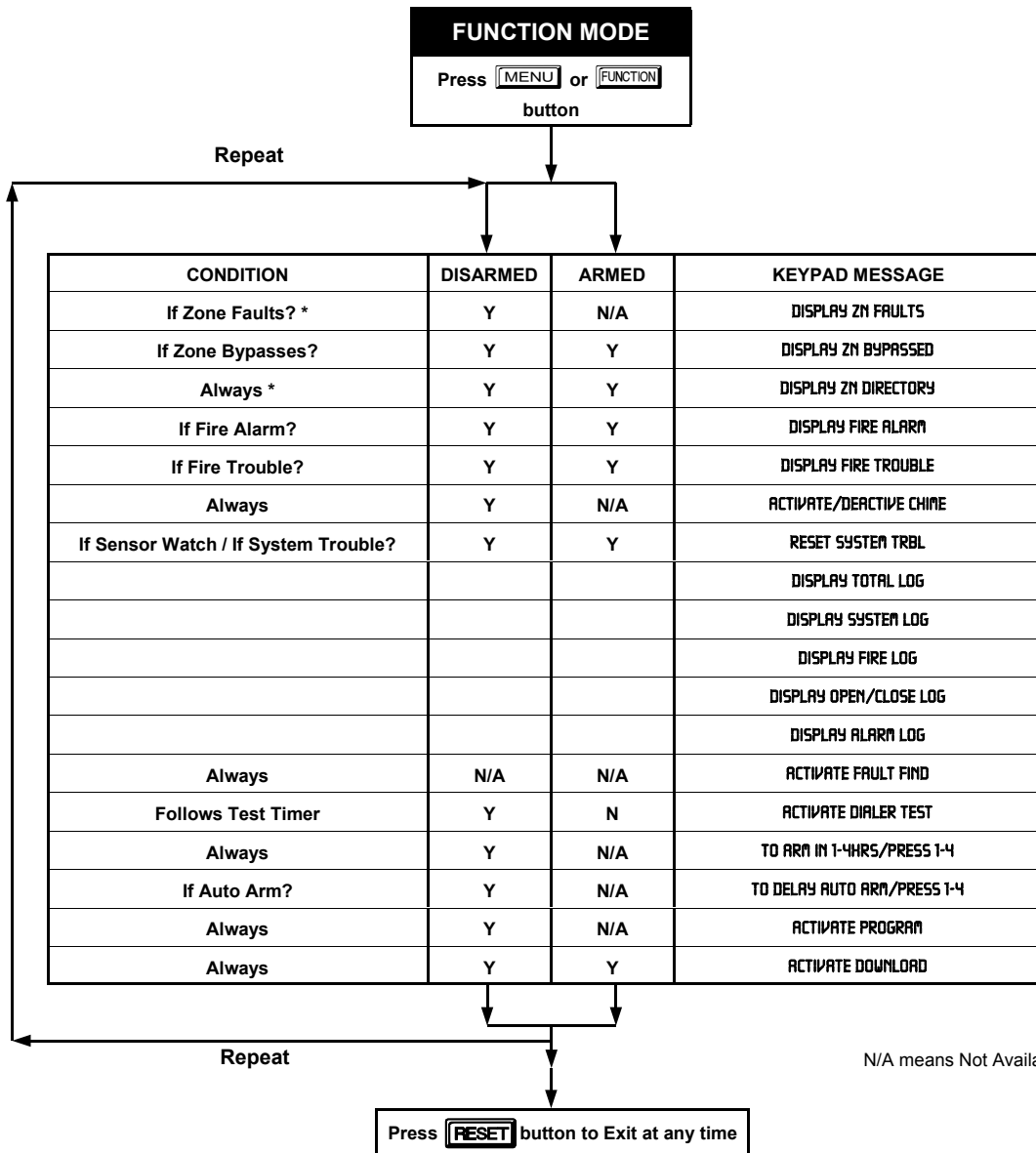
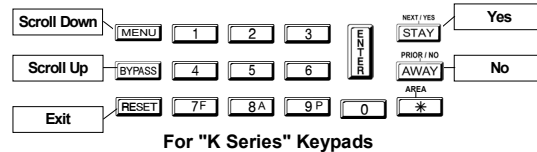
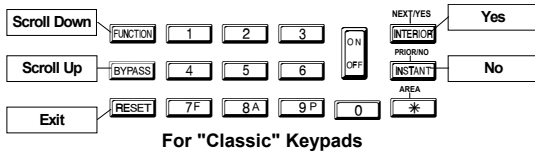

Keypad Programming Modes: Function Mode



# DEALER MODE

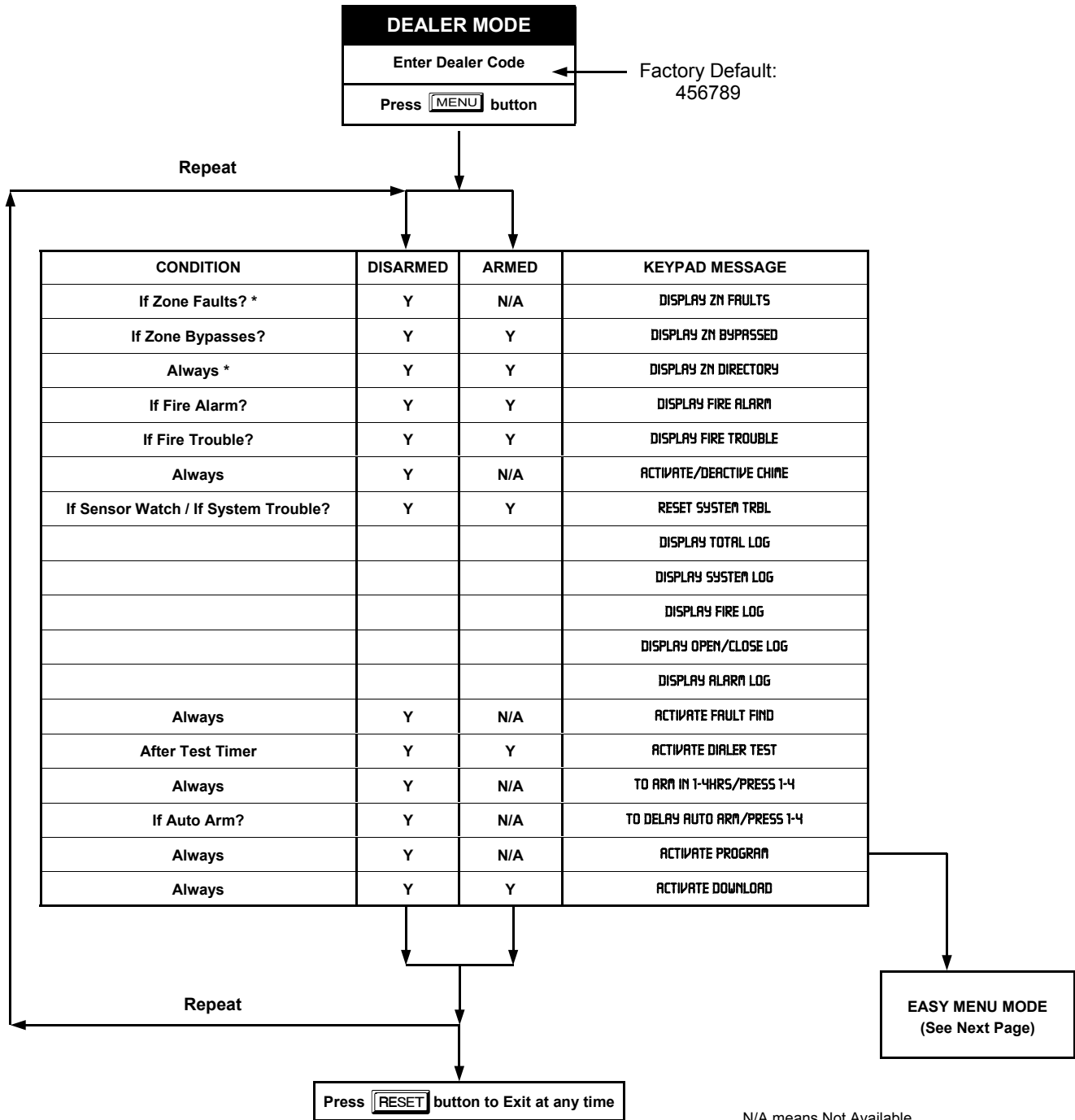
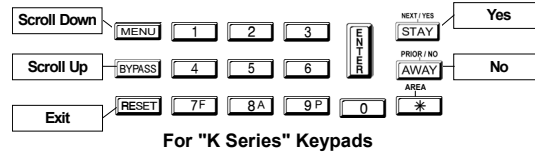
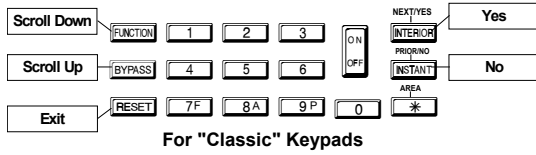

# EASY MENU MODE

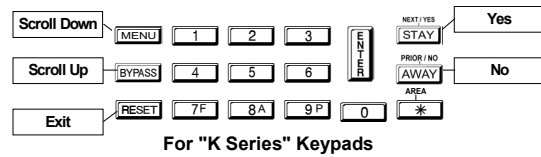
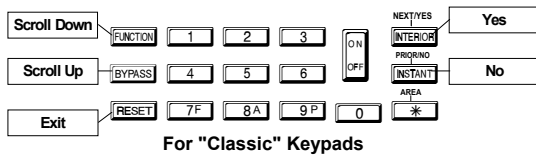

#of Zns in Area1*
EZ Zone Doubling Enabled?*
Fire Zones*
2-Wire Fire Zns*
Report All ZonesTo Central?*
Exit/Entry Zones*
Interior Zones*
24 Hour Zones*
Chime Zones*
Chime 2 Zones*
Exit/Entry 2 Zones*
50mS Loop Zones*
Aux Output Zones*
Sensor Watch Zns*
KP Sndr Alrm Zns*
Auto Byp REnt Zn
Enable No EOLR Zones*
Enable Telco Line Test?*
Enable Burg Out Chirp?*
Enable CP01 Programming?*
# Area 1 Keypads
Central Phone #
Central Station Account #
See WI for Info Rcvr Format
Enter user code
ZN# XMIT#+CS P
KF A XMIT#+CS OP
01 (ZONE DESCRIPTIONS) **
Enter Date**
Enter Time **
Dealer Code
Test Timer

Repeat

Repeat

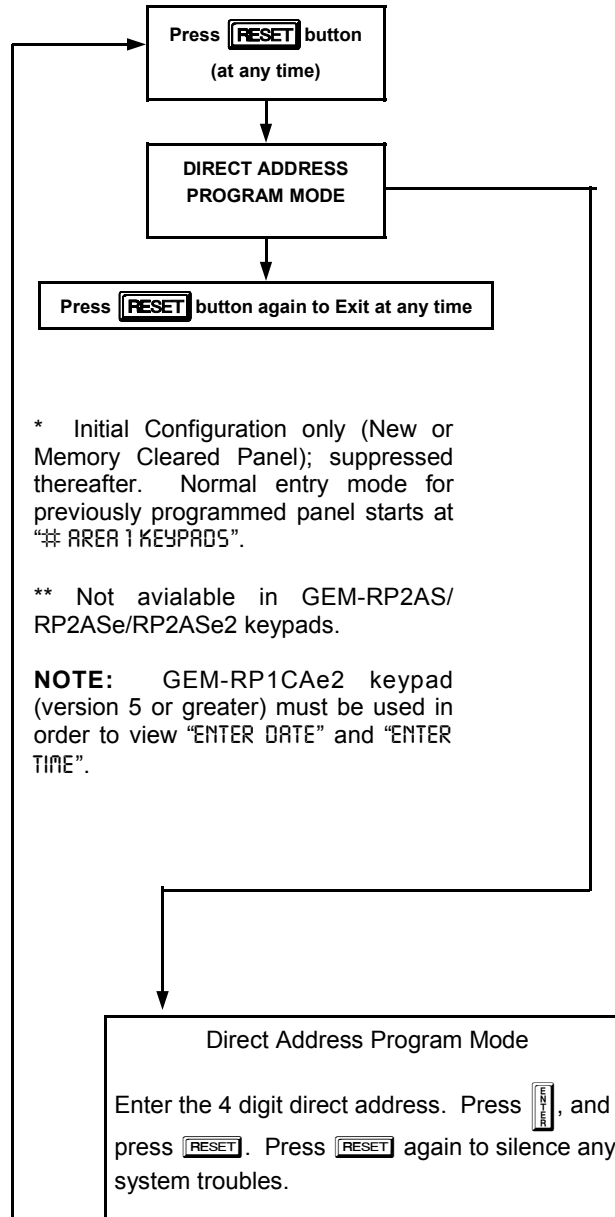

\* Initial Configuration only (New or Memory Cleared Panel); suppressed thereafter. Normal entry mode for previously programmed panel starts at "## AREA 1 KEYPADS".

\*\* Not available in GEM-RP2AS/ RP2ASe/RP2ASe2 keypads.

**NOTE:** GEM-RP1CAe2 keypad (version 5 or greater) must be used in order to view "ENTER DATE" and "ENTER TIME".

# USER MODE

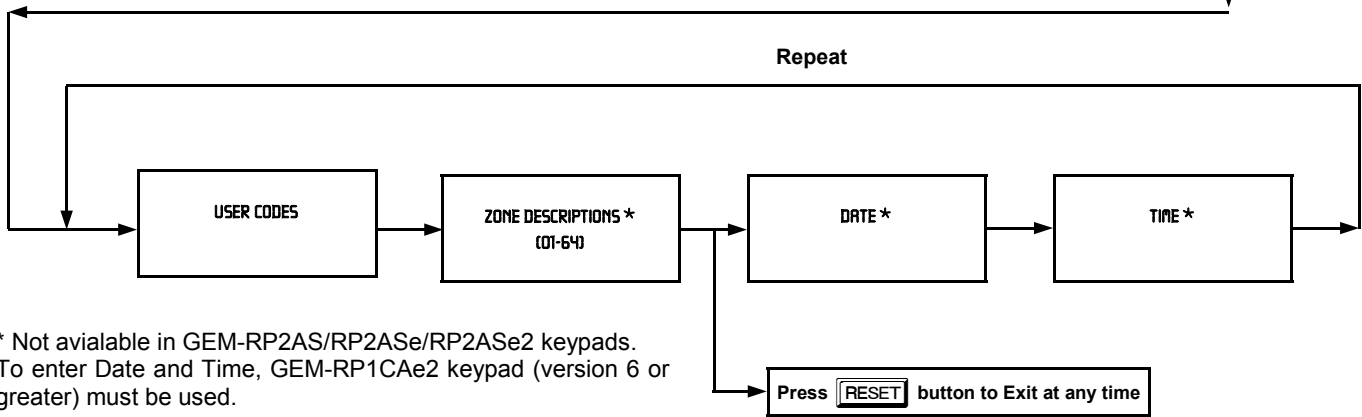
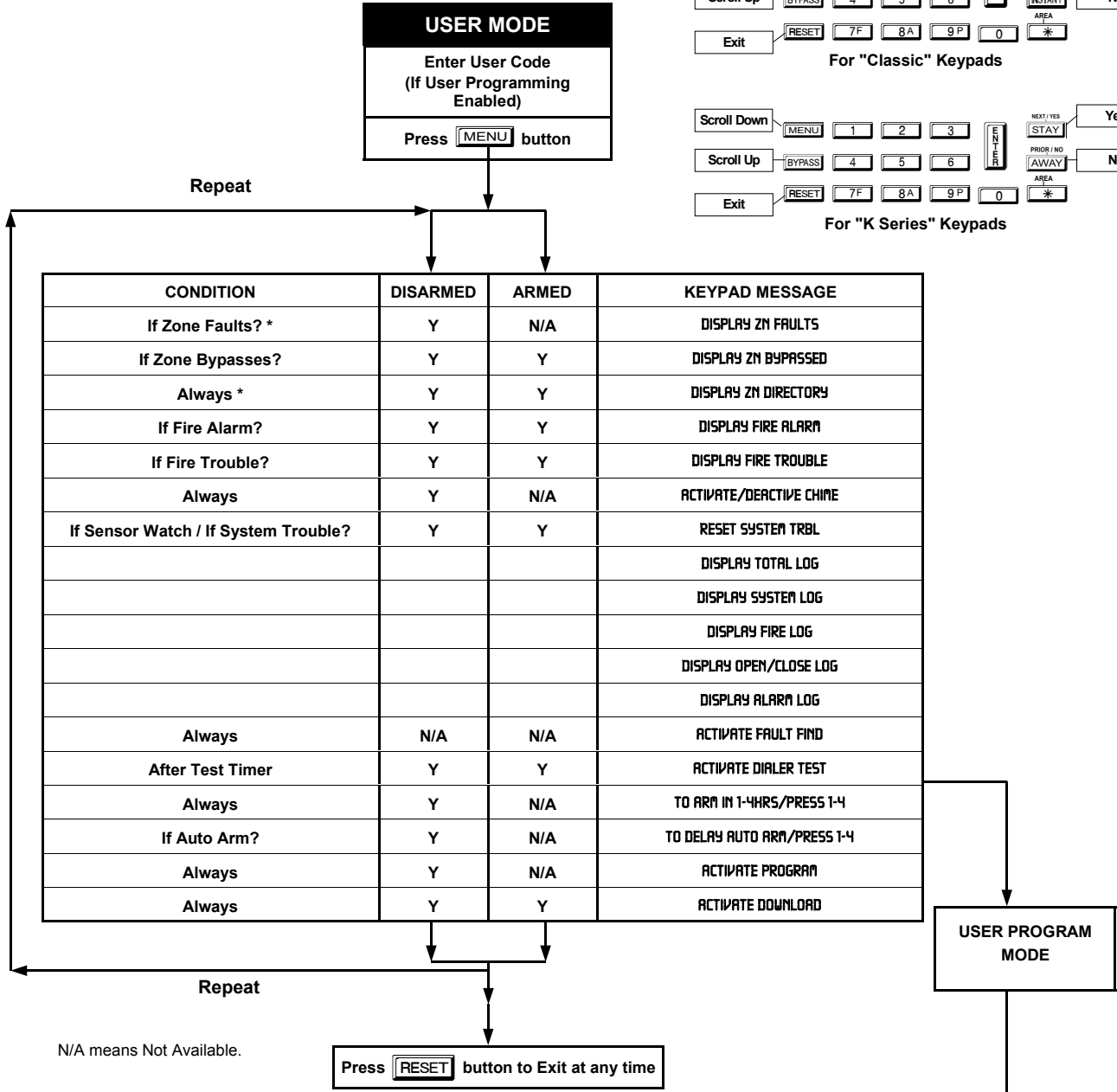
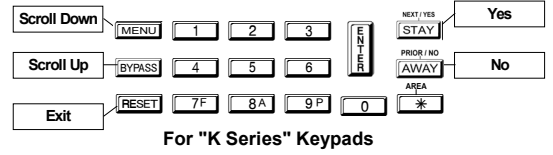
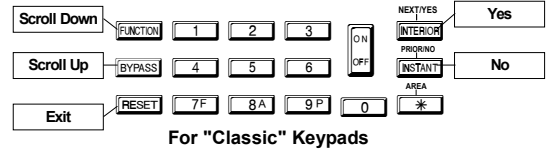

\* Not available in GEM-RP2AS/RP2ASe/RP2ASe2 keypads. To enter Date and Time, GEM-RP1CAe2 keypad (version 6 or greater) must be used.

Keypad Programming Modes: User Mode



# KEYPAD CONFIGURATION MODE

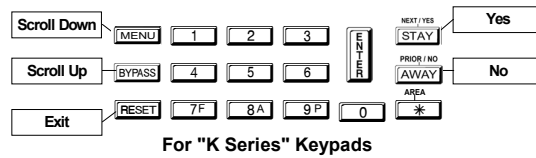
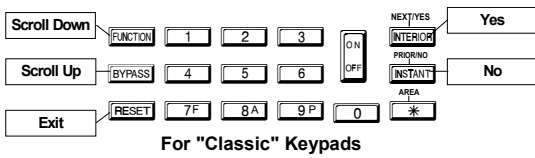

Keypad Programming Modes: Keypad Configuration Mode

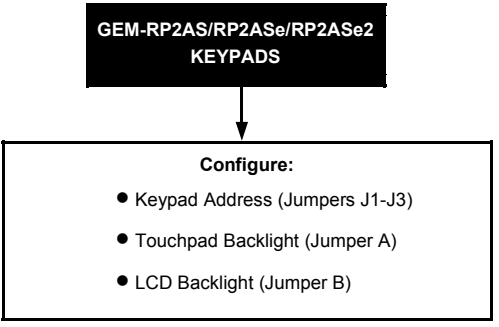
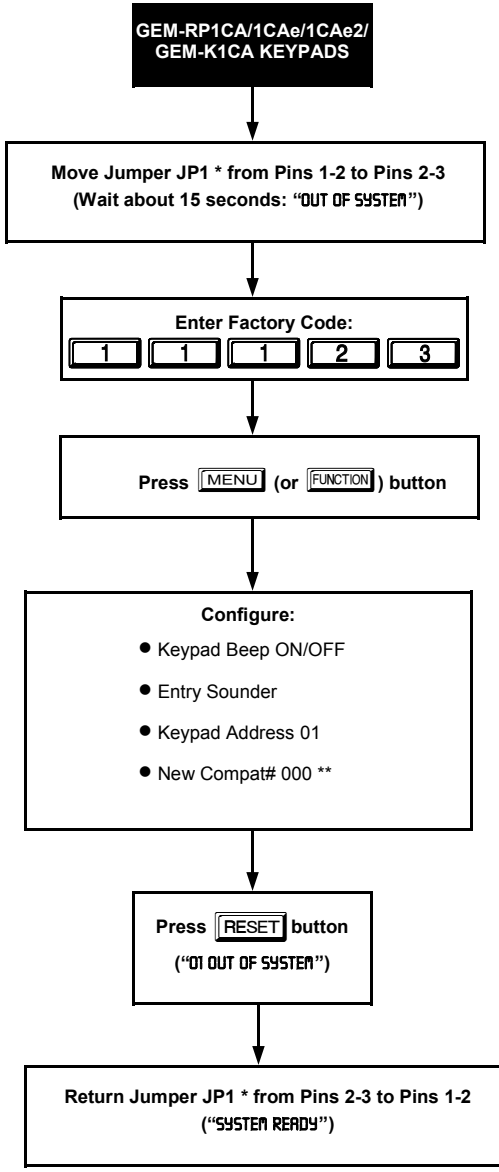

\* JP1 is located at the top center of the circuit board.  
 \*\* Not available in the GEM-P1664.

<b>CP-01 Quick Reference Chart--SIA False Alarm Reduction</b>	
<b>Feature Description</b>	<b>Programming Address Location</b>
CP-01 FEATURES are enabled with one global selection in the panel.	Enabled in EZ Programming
<b>Exit Delay.</b> Minimum allowed programmable Exit Delay time is 45 seconds. Default is 60 seconds. If an attempt is made to change the Exit Delay time to less than 45 seconds the time will be entered as 60 seconds. The maximum programmable time is 255 seconds. The panel uses the existing programmable by zone feature "Entry/ Exit 1" to comply with CP-01. At least one Entry/Exit zone must be programmed for each area. The factory program enables Zone 1 as Entry/Exit and the option to program any zone as Entry/Exit is given in the Easy Program Menu. The existing programmable Entry and Exit delay times are also used. The factory program sets the Exit Time Delay as 60 seconds and Entry Time Delay as 30 seconds. These same times are entered when "Enable CP-01 Features" is selected in the Easy Program Menu.	0000 (Pre-existing)
When " <b>Enable CP-01 Limits</b> " (Address 2053, Bit 3) is enabled, the panel will sound an <b>audible egress</b> sequence when it is armed Away (with interior zones not bypassed). The keypad mini-sounder will beep once every second during the beginning exit delay and beep rapidly the last 10 seconds of exit delay to indicate exit urgency. If the panel is armed Stay (with interior zones bypassed) the keypad mini-sounder is silent and the exit time is double the programmed time. If "Enable CP-01 Limits" (Address 2053, Bit 3) is NOT enabled, the panel will NOT sound an audible egress sequence. <b>Note:</b> This feature affects the operation of "Zone ANDING" as follows: If "Enable CP-01 Limits" is enabled, any Zone in a Group will only activate an alarm and send a report ONCE. After the Zone has reported, it will remain in the Group and may still initiate the Zone ANDING sequence.	2053, Bit 3 (see Note 1) (2053 . . . 4 . . . .)* (2053 · 8)**
<b>Exit Time Restart.</b> This option allows for the following scenario before the end of the Exit Time: a violation of an entry/exit zone, a restore, and a second violation of an entry/exit zone restarts the Exit Time. The panel does not allow the Exit Time to be restarted more than once. The default setting for this option is enabled. Restart is event logged.	2053, Bit 0 (see Note 1) (2053 1 . . . . .)* (2053 · 1)**
<b>Sound Alarm On Exit Error.</b> An Exit Error sequence is initiated if an entry/exit zone is violated at the expiration of the Exit Time. "Exit Error" Central Station Reporting Code is located at address 0706.	2053, Bit 1 (see Note 1) (2053 . 2 . . . . .)* (2053 · 2)**
<b>Unvacated Premises.</b> Convert from Away to Stay based on no egress through exit door ... default is enabled. (GEM-P1664 panel--This feature is Automatic Interior Bypass/ Easy Exit). The panel uses the existing programmable feature "Auto Interior Bypass/Easy Exit". This feature must be enabled in CP-01 installations. This feature is enabled in the factory program and it is also enabled when "Enable CP-01 Features" is selected in the Easy Program Menu.	1424, Bit 0 (1424 1 . . . . .)* (1424 · 1)**
<b>Report Digital Dialer Exit Error/Recent Closing.</b> A Recent Closing transmission is sent if an alarm occurs within two (2) minutes after the expiration of the Exit Time. If the user number is available, it is included in the Recent Closing transmission. "Recent Close" Central Station Reporting Code is located at address 0349. <b>Note:</b> Address 2053, bit 1 must also be set to enable this feature.	2053, Bit 2 (see Note 4) (2053 . . 3 . . . . .)* (2053 · 4)**
<b>Entry Delay.</b> Entry Delay time is 30 second minimum, default is 30 seconds. If an attempt is made to change the Entry Delay time to less than 30 seconds the time will be entered as 30 seconds. The maximum programmable time is 255 seconds. The panel uses the existing programmable by zone feature "Entry/ Exit 1" to comply with CP-01. At least one Entry/Exit zone must be programmed for each area. The factory program enables Zone 1 as Entry/Exit and the option to program any zone as Entry/Exit is given in the Easy Program Menu. The existing programmable Entry and Exit delay times are also used. The factory program sets the Exit Time Delay as 60 seconds and Entry Time Delay as 30 seconds. These same times are entered when "Enable CP-01 Features" is selected in the Easy Program Menu.	0001, 0002 (Pre-existing feature)
<b>Progress Annunciation.</b> Entry urgency annunciation must be different than the alarm mini-sounder. Requires <i>Keypad Sounder on Alarm</i> on all non-fire zones. Locations 0941, 1005, 1069, 1133, 1197, 1261, 1325 and 1389.	Feature in EZ Programming
<b>Disarm.</b> The panel will silence the keypad entry delay tones and alarm annunciation on the first press of a keypad digit for 2.5 seconds.	New Panel Operation
<b>Select Alarm Output for Keyfob Chirp.</b> Normally the chirp on a keyfob arm/disarm is transmitted to the PGM output. Selecting "CHIRP BURG BELL OUTPUT" causes the "Bell" to chirp instead of the PGM on remote Arming. The panel uses the existing programmable feature "Chirp Output on Keyfob Arm/Disarm " (Address 1422, bit 6). This feature must be programmed in a CP-01 installation if a GEM-KEYF is used in the system. The feature is selected in the factory program and is enabled if "Enable CP-01--Enabled" is selected in the Easy Programming Menu.	1423, Bit 7 (see Note 3) (1423 . . . . . 8)* (1423 8 ·)**
<b>Enable CP-01 Limits.</b> When address 2053 bit 3 is enabled, three time limits are enabled as per the SIA CP-01 standards: (1) If the Exit Delay time is programmed for less than 45 seconds, the enabled Exit Delay time will be set to 60 seconds; (2) If the Entry Delay time is programmed for less than 30 seconds, the enabled Entry Delay time will be set to 30 seconds; and (3) If an attempt is made to change the Abort Delay to less than 15 seconds or more than 45 seconds the time will be entered as 30 seconds. (4) Enables Exit Delay sounder. (5) Doubles Exit Delay time when arming Stay due to Silent Exit.	2053, Bit 3 (see Note 1) (2053 . . . 4 . . . .)* (2053 · 8)**
<b>Abort Window Disarm.</b> The panel will silence the keypad entry delay tones and alarm annunciation on the first press of a keypad digit for 2.5 seconds.	New Panel/Keypad Feature
<b>Abort Annunciation after Disarming.</b> Default is enabled. If the panel is disarmed during Abort Delay, the keypad will enunciate abort. "Alarm Cancelled" is displayed on keypad LCD for RP1/K1 and RP2/K2, and "C" in the 7-segment display for the RP3/K3.	New Panel/Keypad Feature
<b>Report Cancel Window.</b> When the system is in alarm and the user disarms in an attempt to Cancel within a minimum of 5 minutes after abort timeout, a Cancel Report will be sent. If Cancel Report is enabled by entering a cancel time (and Abort Delay by zone) Cancel will enunciate on the keypad if the system is disarmed during the Cancel Window. The existing programmable option <i>Report Cancel Window</i> must be programmed for at least 5 minutes in a CP-01 installation. When "Enable CP-01" Features is selected in the easy program menu, this time is set to 7 minutes.	Address 2055
<b>Duress Feature.</b> The existing programmable option " <b>Enable Global Ambush</b> " must not be enabled in CP-01 installations. It is not enabled in the factory program and is not enabled when Enable CP-01 Feature is selected in the Easy Program Menu.	Pre-existing feature



<p><b>Duress Code.</b> The panel will not allow duplicate User Codes to be programmed. Every user program code may now be selected as an Ambush Code for Area 1 or Area 2 by entering a _5 in the Area 1 Options or Area 2 Options respectively. <b>Note:</b> Keypad(s) must be enabled for Ambush.</p>	<p>New Operation of the Panel</p>
<p><b>Cross Zoning.</b> Required Option for cross zoning with either programmable time period or specified by manufacturer. Default is disabled. The existing programmable by zone feature "Zone ANDing Groups" are available for the cross zoning option required by CP-01. This feature is not enabled in the factory program and not enabled when Enable CP-01 Features are enable in the Easy Program Menu. Cross Zone set time = one (1) minute.</p>	<p>Pre-existing feature</p>
<p><b>Swinger Shutdown.</b> Zone will only trip once and will not restore automatically. "Auto-Reset" (Addresses 0917, 0981, 1045, 1109, 1173, 1237, 1301 and 1356) and "Swinger Shutdown" (Addresses 0918, 0982, 1046, 1110, 1174, 1238, 1302 and 1366) are disabled in order to meet the CP-01 requirement of only one alarm activation per zone during an arming period. These features are not selected on zones 1-8 in the factory program and are removed from all zones when "Enable CP-01 Features" is selected in the Easy Program Menu. In a SIA CP-01 installation, these options must not be selected. Auto-Reset must be programmed for all burglary zones in a UL Installation. See the glossary entry, "Swinger Shutdown" in this manual.</p>	<p>Pre-existing features</p>
<p><b>Fire Alarms.</b> Fire Alarm Verification available option on Fire Zones. Default is disabled. The existing programmable option "Fire Alarm Verification" is available as required by CP-01. This feature is not enabled in the factory program and not enabled when "Enable CP-01 Features" is selected in the Easy Program Menu.</p>	<p>Pre-existing feature</p>
<p><b>Call Waiting.</b> Disable Call Waiting on 1st Attempt. Default is disabled. When enabled, the telephone number must be programmed with *70 in front of the telephone number. The first attempt will dial with *70 (disabling call waiting). Subsequent attempts (if first attempt is unsuccessful) will dial without *70. <b>Note:</b> The digits used to disable Call Waiting may vary with location. Be sure to confirm with local telephone company. <b>Note:</b> Disabling Call Waiting on a non Call-Waiting line can result in a delay in the connection to Central Station.</p>	<p>2053, Bit 5 (see Note 2) (2053 . . . . . 6 . . .)* (2053 2 . . .)**</p>
<p><b>System Test.</b> Test Mode for all zones, the sounders, and communicator. The "Fault Find" function (a Function Menu selection) is enabled, and normally causes all hardwired zones to give a two second beep at the keypad(s) when any zone is faulted or restored. As required by SIA CP-01, Fault Find is expanded with the following features when <b>Digital Dialer Report Enter/Exit Test Mode</b> is programmed. This option is programmed when "Enable CP-01 Feature" is selected in the Easy Program Menu:</p> <ul style="list-style-type: none"> <li>• When Fault Find is entered, it reports to Central Station that "Test Mode" is in progress.</li> <li>• Fault Find can not be initiated from an armed panel, and all digital dialer reporting in same area is inhibited while in Fault Find.</li> <li>• Fault Find Central Station Reporting Code is located at address 2053.</li> <li>• Keypad will display the following warning that the system is in Fault Find: "FAULT FIND RF SIG POWER - -"</li> <li>• If a 24-hour zone is tripped and not restored during Fault Find, when the mode is exited the zone will display as "Faulted" on the keypad display.</li> <li>• When Fault Find is exited by pressing <b>[RESET]</b>, a Fault Find Restore Report will be sent.</li> </ul>	<p>2053, Bit 4 (see Note 4) (2053 . . . . . 5 . . .)* (2053 1 . . .)**</p>
<p><b>Notes:</b></p> <p><b>Note 1:</b> This feature is enabled in the factory program and is enabled when "Enable CP-01 Features" is selected in the Easy Program Menu. This feature must be enabled in CP-01-compliant installations.</p> <p><b>Note 2:</b> This feature is not enabled in the factory program and is not enabled when "Enable CP-01 Features" is selected in the Easy Program Menu.</p> <p><b>Note 3:</b> This feature is enabled in the factory program and is enabled when "Enable CP-01 Features" is selected in the Easy Programming Menu. This feature must be programmed in CP-01-compliant installations if a GEM-KEYF is used in the system.</p> <p><b>Note 4:</b> This feature is programmed when "Enable CP-01 Features" is selected in the Easy Programming Menu.</p> <ul style="list-style-type: none"> <li>• At least one Exit/Entry zone must be programmed for each area. (SIA CP-01 Specification 4.2.1)</li> <li>• The GEM-P1664 control panel and at least one GEM-RP1CAe2/GEM-K1CA, GEM-RP2ASe2/GEM-K2AS or a GEM-RP3DGTL/GEM-K3DGTL must be installed.</li> <li>• The following optional accessories support the SIA False Alarm Reduction (FAR) classification, and may be used if desired: GEM-EZOUT8, GEM-RB3008, GEM-RM3008, GEM-EZM8, GEM-EZM4/8, GEM-RECV8/16/32, GEM-TRANS2, GEM-PIR, GEM-SMOKE, GEM-HEAT, GEM-KFOB.</li> <li>• Programming at Installation may be subordinate to other UL requirements for the intended application.</li> <li>• Un-vacated premises: When the system/partition is armed with AWAY button, the system will arm STAY if no exit. There must be a minimum of one Stay/Away or Delay Stay/Away zone enrolled on the partition.</li> <li>• Cross zoning is not recommended for Line security Installations nor is it to be implemented on exit / entry zones.</li> <li>• There is a Communication Delay of 30 seconds in this control panel. It can be removed, or it can be increased up to 45 seconds at the option of the end user by consulting with the Installer.</li> <li>• Do not duplicate any reporting codes. This applies for all communication formats other than SIA sending automatic programmed reporting codes.</li> <li>• In UL installations, Entry Delay time plus Abort Delay time (total combined times) cannot exceed 60 seconds.</li> <li>• Exit Time Restart must be disabled for UL Line Security/Encryption applications.</li> </ul>	

\*Illustrates the LCD display for the GEM-RP1CAe2 and GEM-K1CA keypads.

\*\*Illustrates the LCD display for the GEM-RP2ASe2/GEM-K2AS, and GEM-RP3DGTL/GEM-K3DGTL keypads. Although the data is the same, the GEM-RP3DGTL/GEM-K3DGTL keypads will *display* the data differently--the address location number scrolls, then disappears briefly; the keypad will then display the data entry locations.

# GEM-P1664 FACTORY DEFAULT DESCRIPTION

The Factory Program of the GEM-P1664 will change with the release of the new version that complies with Security Industry Association False Alarm Reduction Control Panel-01 Standard (SIA FAR CP-01).

## Out of Box Panel Operation

The following describes the new panel factory defaults:

The new SIA CP-01 compliant versions of the GEM-P1664 panels have a factory program that allows a locally functioning alarm panel out of the box, programmed with all the non-reporting features required by the SIA CP-01 standard.

The new versions of the panels are manufactured with the following factory programmed features:

1. All zones (64 in the GEM-P1664) are programmed for Priority, Selective Bypass, Alarm Output, Keypad Sounder on Alarm and Abort Delay.
2. Default User 1 Code = "123" and it is set up to arm Area 1 and be a user program code.
3. Keypad Time/Date Display enabled.
4. The reporting format is Ademco, Silent Knight Slow.
5. Touch Tone with Rotary Back-up is enabled.
6. Exit Delay = 60 seconds.
7. Entry Delay 1 and 2 are both 30 seconds.
8. AC Fail Report Delay is 60 minutes.
9. Alarm and Pulse Alarm time-outs are 5 minutes.
10. Chime is set to 2 seconds.
11. Change Pulse Alarm to Cadence Alarm is enabled.
12. Auto Reset after Burglary Output Timeout is enabled.
13. 1422-Bit 6 "Chirp Output on Keyfob Arm/Disarm" is enabled.
14. 1424-Bit 0 "Automatic Interior Bypass/Easy Exit" is enabled.
15. 1423-Bit 7 "Select Alarm Output for Keyfob Chirp" is enabled.
16. 2053-Bit 0 "Exit Time Restart" is enabled.
17. 2053-Bit 1 "Sound Alarm on Exit Error" is enabled.
18. 2053-Bit 3 "Enable CP-01 Limits" is enabled.
19. 1417 "Abort Delay" is changed to 30 seconds.
20. Cancel Time ("Cancel Window Duration") is set to zero minutes.

The complete Easy Programming menu will appear upon initial entry into Dealer Program Mode. Subsequent entry into Dealer Program Mode allows only a subset of the Easy Program Menu.

With this new SIA CP-01 compliant panel, the Easy Program Menu has been increased to allow several additional features to be programmed in the Menu, rather than requiring that these features be programmed through the Direct Address programming method. **Note:** Upon entering Dealer Program Mode, the above referenced factory program is immediately cleared and the "Prior to CP-01 Changes" (see below) factory program is loaded. Therefore, if you enter Dealer Program Mode, you will be required to first enter Easy Program Mode and answer Easy Program Mode questions before making any needed changes to the factory program via Direct Address Programming Mode.

Once the panel is removed from its box, you have three choices: (1) Do not enter Dealer Program Mode and complete the installation using the unmodified factory program; (2) Upload the Factory Default Program (above) to PCD-Windows, make desired changes, and re-download this modified PCD-Windows program back to the panel; (3) Enter Dealer Program Mode in order to allow the EZ Program Menu to appear, then answer "Yes" to the question "**Enable CP-01 Features?**".

A critical addition to the Easy Program Menu is the question "**Enable CP-01 Features? Y/N**". If the answer to this question is "**No**" then the following changes to the program occur:

1. All zones (64 in the GEM-P1664) are programmed for Priority, Selective Bypass, Alarm Output, Auto Reset and Swinger Shutdown. Only the zones selected by the first EPM question "How many Zones" are programmed for Area 1.
2. Default User 1 Code = "123" and it is set up to arm Area 1 and be a user program code.
3. Keypad Time/Date Display enabled.
4. All zones are programmed with report codes and as burg/fire alarm types depending on whether they were selected as fire zones. Zones not selected as fire are burg type.
5. The reporting format is selectable in the Easy Program Mode.
6. Touch Tone with Rotary Back-up is enabled.
7. Exit Delay = 60 seconds.
8. Entry Delay 1 and 2 are both 30 seconds.
9. AC Fail Report Delay is 60 minutes.



10. Alarm and Pulse Alarm time-outs are 15 minutes.
11. Chime is set to 2 seconds.
12. Change Pulse Alarm to Cadence Alarm is enabled.
13. Auto Reset after Burglary Output Timeout is enabled.

If the answer to the question “**Enable CP-01 Features? Y/N**” is “**Yes**”, then the following changes to the above program occur:

1. Auto Reset and Swinger Shutdown are removed from burg zones.
2. 1422-Bit 6 "Chirp Output on Keyfob Arm/Disarm" is enabled.
3. 1424-Bit 0 "Automatic Interior Bypass/Easy Exit" is enabled.
4. 1423-Bit 7 "Select Alarm Output for Keyfob Chirp" is enabled.
5. 2053-Bit 0 "Exit Time Restart" is enabled.
6. 2053-Bit 1 "Sound Alarm on Exit Error" is enabled.
7. 2053-Bit 2 "Report Digital Dialer Exit Error/Recent Closing" is enabled.
8. 2053-Bit 3 "Enable CP-01 Limits" is enabled.
9. 2053-Bit 4 "Digital Dialer Report Enter/Exit Test Mode" is enabled.
10. 1417 "Abort Delay" is changed to 30 seconds.
11. Cancel Time ("Cancel Window Duration") is set to 7 minutes.

Subsequent entering of the Dealer Program allows only a subset of the Easy Program Menu which does not include the question “Enable CP-01 Features” and prevents the existing program from being deleted, but allows the system to be expanded. The CP-01 Quick Reference Chart (see pages 59-60 of this manual) and the explanation of the Easy Program Question “Enable CP-01” (above) should be reviewed before installing the panel.

**Note:** When address 2053 "Enable CP-01 Limits" is enabled, the Exit Delay keypad sounder (including the Exit Urgency sound during the final 10 seconds of the Exit Delay) is enabled.

#### **Out of Box Panel Operation (Prior to CP-01 Changes)**

The following describes the control panel factory defaults that are loaded if you enter the Dealer Program Menu, which is also the factory default used with these panels prior to modifications made in order to comply with the CP-01 requirements:

The program has minimum defaults, programmed with 8 hardwire zones (Zones 1-8) programmed in Area 1. No other zone features were enabled and no alarms could be generated. Other features included:

- 1) Default User 1 Code = "123" and enabled as an Arming Code in Area 1.
- 2) Dealer Program Default Code = "456789".

After powering up, the installer is required to enter Program Mode using the Dealer Program Default Code of "456789".

The Easy Program mode that is entered is a series of questions regarding the required functions of the particular installation. After exiting the Easy Program Mode, the installer could complete the installation. Subsequent entering of Dealer Program Mode allows only a subset of the Easy Program menu that prevents the existing program from being deleted, but allows the system to be expanded.



## FCC STATEMENT

This equipment generates and uses radio-frequency energy and, if not installed and used properly, that is, in strict accordance with the manufacturer's instructions, may cause interference to radio and television reception. It has been type tested and found to comply with the limits for a Class-B computing device in accordance with the specifications in Subpart J of Part 15 of FCC Rules, which are designed to provide reasonable protection against such interference in a residential installation.

However, there is no guarantee that interference will not occur in a particular installation. If this equipment does cause interference to radio or television reception, which can be determined by turning the equipment off and on, the user is encouraged to try to correct the interference by one or more of the following measures: reorient the receiving antenna; relocate the computer with respect to the receiver; move the computer away from the receiver; plug the computer into a different outlet so that computer and receiver are on different branch circuits.

If necessary, the user should consult the dealer or an experienced radio/television technician for additional suggestions. The user may find the following booklet prepared by the Federal Communications Commission helpful: "How to Identify and Resolve Radio-TV Interference Problems". This booklet is available from the U.S. Government Printing Office, Washington, DC 20402; Stock No. 004-000-00345-4.

**CAUTION:** This equipment generates and uses radio-frequency energy. If not installed using conventional installation practices for RF devices, it may cause interference to radio and television reception. It has been tested and found to comply with the limits for a Class A computing device pursuant to Subpart B of Part 15 of FCC Rules, which are designed to provide reasonable protection against such interference. However, there is no guarantee that interference will not occur in a particular installation. If it has been found to cause interference to radio or television reception, which can be determined by removing and reapplying AC and battery power to the equipment, the installer should try to correct the interference by one or more of the following measures: reorient the receiving antenna; connect the power transformer to a different outlet so that the control panel and receiver are on different branch circuits; relocate the control panel with respect to the receiver.



# NOTES

# GEM-P1664 WIRING DIAGRAM



**NAPCO SECURITY SYSTEMS, INC.**  
AMITYVILLE, N.Y. 11701

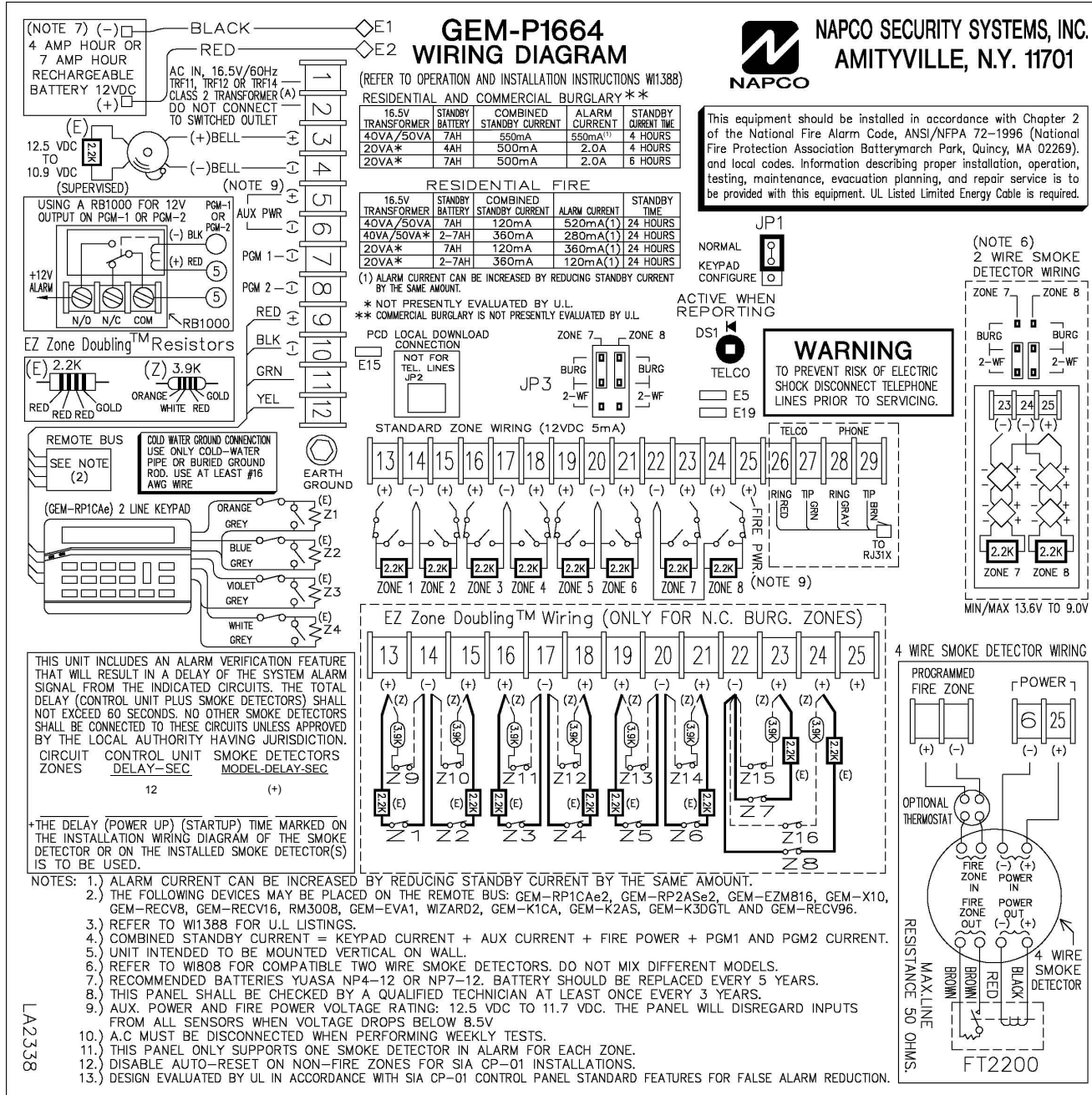

GEM-P1664 Wiring Diagram

LA2338



## NAPCO LIMITED WARRANTY

NAPCO SECURITY SYSTEMS, INC. (NAPCO) warrants its products to be free from manufacturing defects in materials and workmanship for *thirty-six months* following the date of manufacture. NAPCO will, within said period, at its option, repair or replace any product failing to operate correctly without charge to the original purchaser or user.

This warranty shall not apply to any equipment, or any part thereof, which has been repaired by others, improperly installed, improperly used, abused, altered, damaged, subjected to acts of God, or on which any serial numbers have been altered, defaced or removed. Seller will not be responsible for any dismantling or reinstallation charges.

THERE ARE NO WARRANTIES, EXPRESS OR IMPLIED, WHICH EXTEND BEYOND THE DESCRIPTION ON THE FACE HEREOF. THERE IS NO EXPRESS OR IMPLIED WARRANTY OF MERCHANTABILITY OR A WARRANTY OF FITNESS FOR A PARTICULAR PURPOSE. ADDITIONALLY, THIS WARRANTY IS IN LIEU OF ALL OTHER OBLIGATIONS OR LIABILITIES ON THE PART OF NAPCO.

Any action for breach of warranty, including but not limited to any implied warranty of merchantability, must be brought within the six months following the end of the warranty period.

IN NO CASE SHALL NAPCO BE LIABLE TO ANYONE FOR ANY CONSEQUENTIAL OR INCIDENTAL DAMAGES FOR BREACH OF THIS OR ANY OTHER WARRANTY, EXPRESS OR IMPLIED, EVEN IF THE LOSS OR DAMAGE IS CAUSED BY THE SELLER'S OWN NEGLIGENCE OR FAULT.

In case of defect, contact the security professional who installed and maintains your security system. In order to exercise the warranty, the product must be returned by the security professional, shipping costs prepaid and insured to NAPCO. After repair or replacement, NAPCO assumes the cost of returning products under warranty. NAPCO shall have no obligation under this warranty, or otherwise, if the product has been repaired by others, improperly installed, improperly used, abused, altered, damaged, subjected to accident, nuisance, flood, fire or acts of God, or on which any serial numbers have been altered, defaced or removed. NAPCO will not be responsible for any dismantling, reassembly or reinstallation charges.

This warranty contains the entire warranty. It is the sole warranty and any prior agreements or representations, whether oral or written, are either merged herein or are expressly cancelled. NAPCO neither assumes, nor

authorizes any other person purporting to act on its behalf to modify, to change, or to assume for it, any other warranty or liability concerning its products.

In no event shall NAPCO be liable for an amount in excess of NAPCO's original selling price of the product, for any loss or damage, whether direct, indirect, incidental, consequential, or otherwise arising out of any failure of the product. Seller's warranty, as hereinabove set forth, shall not be enlarged, diminished or affected by and no obligation or liability shall arise or grow out of Seller's rendering of technical advice or service in connection with Buyer's order of the goods furnished hereunder.

NAPCO RECOMMENDS THAT THE ENTIRE SYSTEM BE COMPLETELY TESTED WEEKLY.

**Warning:** Despite frequent testing, and due to, but not limited to, any or all of the following; criminal tampering, electrical or communications disruption, it is possible for the system to fail to perform as expected. NAPCO does not represent that the product/system may not be compromised or circumvented; or that the product or system will prevent any personal injury or property loss by burglary, robbery, fire or otherwise; nor that the product or system will in all cases provide adequate warning or protection. A properly installed and maintained alarm may only reduce risk of burglary, robbery, fire or otherwise but it is not insurance or a guarantee that these events will not occur. CONSEQUENTLY, SELLER SHALL HAVE NO LIABILITY FOR ANY PERSONAL INJURY, PROPERTY DAMAGE, OR OTHER LOSS BASED ON A CLAIM THE PRODUCT FAILED TO GIVE WARNING. Therefore, the installer should in turn advise the consumer to take any and all precautions for his or her safety including, but not limited to, fleeing the premises and calling police or fire department, in order to mitigate the possibilities of harm and/or damage.

NAPCO is not an insurer of either the property or safety of the user's family or employees, and limits its liability for any loss or damage including incidental or consequential damages to NAPCO's original selling price of the product regardless of the cause of such loss or damage.

Some states do not allow limitations on how long an implied warranty lasts or do not allow the exclusion or limitation of incidental or consequential damages, or differentiate in their treatment of limitations of liability for ordinary or gross negligence, so the above limitations or exclusions may not apply to you. This Warranty gives you specific legal rights and you may also have other rights which vary from state to state.

