



Ranger 8600

Installation Manual

**RANGER 8600
DOWNLOADABLE CONTROL COMMUNICATOR
INSTALLATION MANUAL**

TABLE OF CONTENTS

1. TABLE OF CONTENTS.....	P.1
2. GENERAL DESCRIPTION	P.2
3. STANDARD AND OPTIONAL PARTS LIST	P.2
4. PARTS DIAGRAM	P.3
5. TERMINAL DRAWING AND SPECIAL NOTES.....	P.4
6. TERMINAL DESCRIPTION.....	P.5
7. HOW TO PROGRAM THE RANGER 8600.....	P.6
8. KEYPAD PROGRAMMING EXAMPLES.....	P.7
9. OPTIONAL #8950 PROGRAMMER EXAMPLE.....	P.7
10. REQUIRED PROGRAMMING INSTRUCTIONS.....	P.8
11. PROGRAMMING WORK SHEETS.....	P.10-12
12. COMMUNICATOR FORMAT SELECTION GUIDE.....	P.13
13. OPTIONAL PROGRAMMING INSTRUCTIONS.....	P.15-31
14. DOWNLOAD PROGRAMMING INSTRUCTIONS.....	P.31
15. GENERAL OPERATING INSTRUCTIONS.....	P.32
16. KEYPAD OPERATION.....	P.35
17. LOCAL TELEPHONE COMPANY INTERFACE INFO.....	P.36
18. SPECIFICATIONS & WARRANTY.....	P.38

**CADDX-CADDI CONTROLS, INC.
GLADEWATER, TEXAS 903-845-6941**

RANGER 8600

INSTALLATION MANUAL

General Description

The Caddx Ranger 8600 is a versatile 6 zone security control with a built-in digital communicator. Its microcomputer design gives some of the most versatile, yet easy to use features available for most security applications today. Each of the six zones can be programmed to be one of nine different types including 24 Hour, Interior Follower, and Day zone. Each zone is individually annunciated and can be bypassed from the keypad. See page 15 for a description of all zone types. Read the **OPERATORS MANUAL** before you begin the installation for the best overall description of how the Ranger 8600 functions. After installation of the security system, complete the information on page 1 of the operators manual and explain the system operation to all security system owners/operators.

Standard Parts List.

The Ranger 8600 is shipped with the parts listed below.

QUANTITY	PART DESCRIPTION	PART NO.
1	MASTER CONTROL PANEL	8600
1	REMOTE KEYPAD	8601
1	16.5 VAC, 25VA TRANSFORMER	T-1625
8	3.3K, 1/2 WATT E.O.L. RESISTORS	EOL-33
1	INSTALLATION MANUAL	IM-8600-C
1	OPERATORS MANUAL	OM-8600

Optional Parts List.

The following parts are available for use with the Ranger 8600.

OPTIONAL PARTS DESCRIPTION	PART NO.
LCD KEYPAD	9050
PROGRAMMER WITH DIGITAL NUMERIC DISPLAY	8950
DOWNLOADING SOFTWARE PACKAGE	DL-900
MAINTENENCE CODE GENERATING SOFTWARE	CG-800
CAMLOCK W/KEYS AND RETAINER	600-CL
12VDC 6AH BATTERY	B-1260

PARTS DIAGRAM

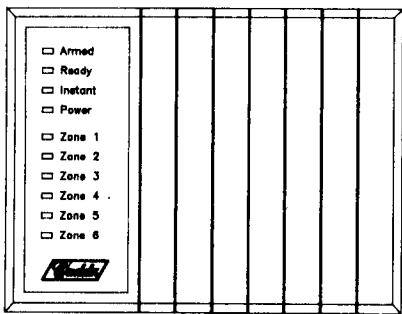
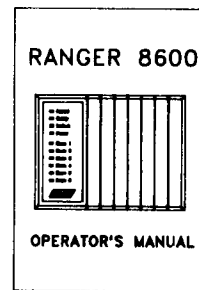
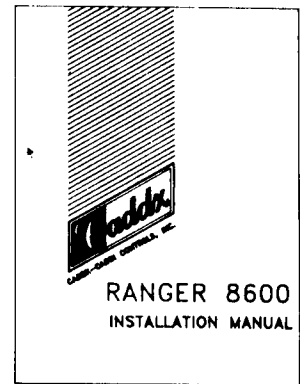
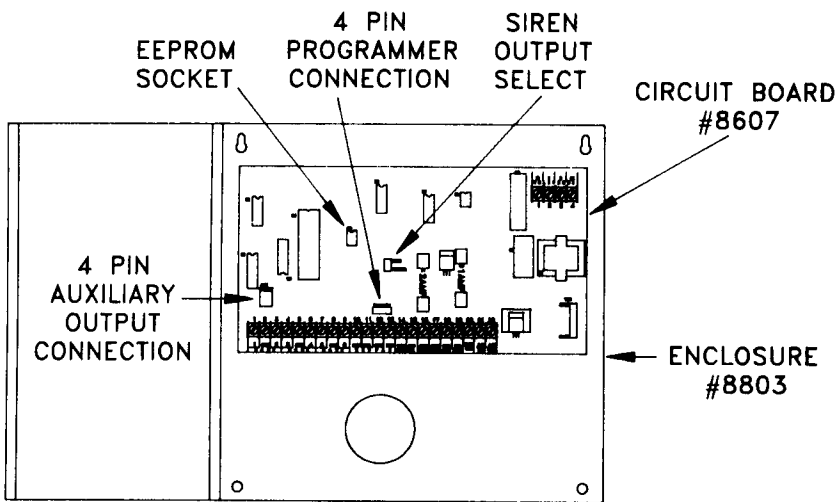

KEYPAD WITH BACKLIGHTING
#8601

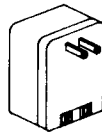

TRANSFORMER
#T-1625

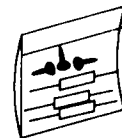

HARDWARE
PACK

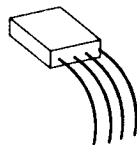

4 WIRE
CONNECTOR
FOR AUX OUTPUT
#8920 (OPTIONAL)

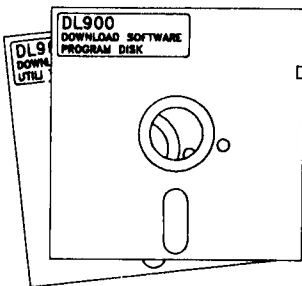

SOFTWARE PACKAGE
#DL900 (OPTIONAL)

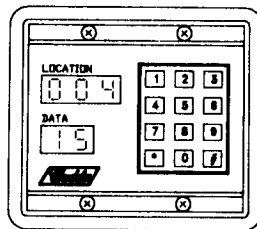

PROGRAMMER
#8950 (OPTIONAL)

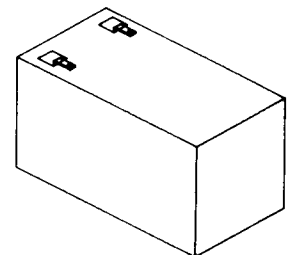

BATTERY
#B-1260 (OPTIONAL)

Terminal drawing and special notes

**CADDX
RANGER
8000/8600**
CADDX-CADDI CONTROLS, INC.
GLADEWATER, TX 75647

WARNING - FOR CONTINUED PROTECTION AGAINST THE RISK OF FIRE REPLACE ONLY WITH THE SAME TYPE AND RATING OF FUSE F1 = 2 AMP F2 = 1 AMP

WARNING - TO PREVENT RISK OF ELECTRIC SHOCK ALWAYS DISCONNECT THE TELEPHONE LINE PRIOR TO SERVICING

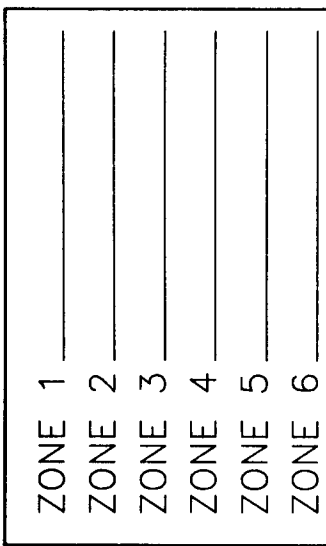
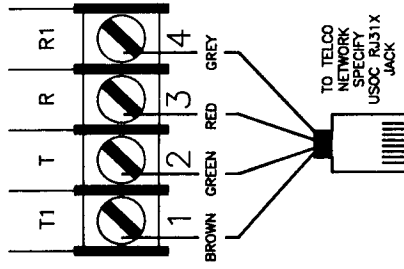

FOR ADDITIONAL INFORMATION AND INSTRUCTIONS REFER TO THE APPROPRIATE INSTALLATION AND OPERATION MANUALS.

KEYPAD

- 1) MAXIMUM 4 KEYPADS PER SYSTEM
- 2) MAXIMUM WIRE RUN PER KEYPAD
a. 22 GAUGE WIRE: 200 FEET
b. 18 GAUGE WIRE: 500 FEET
- 3) DO NOT DAISSY CHAIN KEYPADS. EACH MUST HAVE AN INDIVIDUAL WIRE RUN.
- 4) ADDITIONAL KEYPADS DRAW 60 mA

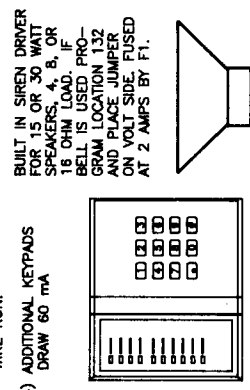

LIGHTNING PROTECTION
THE CONTROL PANEL MUST BE EARTH GROUNDED FOR LIGHTNING PROTECTION TO WORK EFFECTIVELY. THE GROUND CONNECTION SHOULD BE TO A VERIFIED COLD WATER GROUND PIPE OR A DEDICATED DRIVEN METAL ROD 6" TO 10" LONG. USE MINIMUM 14 GAUGE WIRE.

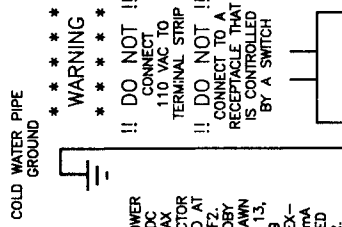

WARNING
DO NOT !!
CONNECT 110 VAC TO TERMINAL STRIP
DO NOT !!
CONNECT TO A RECEPTACLE THAT IS CONTROLLED BY A SWITCH

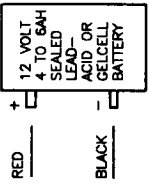
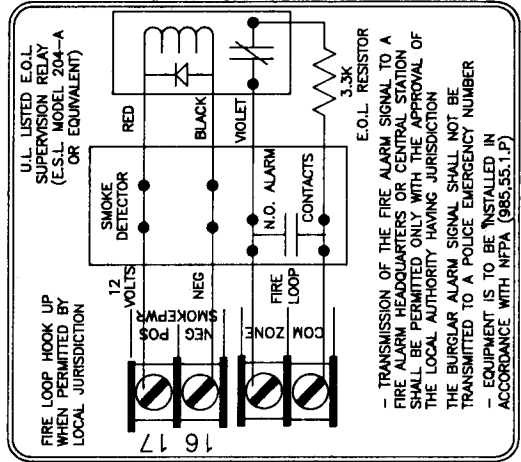
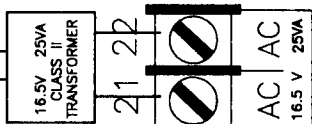

BATTERY CAPACITY FOR EMERGENCY STANDBY AT LEAST 4 HOURS
CONTROL PANEL DRAWS 200mA STANDBY POWER

TERMINAL DESCRIPTION

TERMINAL NO.	DESCRIPTION
1	Connect one side of zone 1 loop. The other side of loop to common terminal 2. Open or short causes alarm.
2	Common (-) Terminal
3	Connect one side of zone 2 loop. The other side of loop to common terminal 2. Open or short causes alarm.
4 - 9	See Terminal Drawing and repeat the above sequence for zones 3-6
10,11,12,13	Connect keypad wires as follows; yellow to terminal 10, green to terminal 11, black to terminal 12, red to terminal 13. 200 ft. maximum run with 22 gauge wire, 500 ft. maximum run with 18 gauge wire. Home run cable to each keypad.
14(-)& 15(+)	Siren driver output to speaker(s), (speaker rating should be 15 watt at 8 or 16 ohm, or 30/40 watt at 4, 8, or 16 ohms). If siren driver disable is selected in location 132, output becomes voltage output, 12VDC, 1 Amp maximum load.
16(-)& 17(+)	Smoke detector power 12VDC, 100 mA maximum (For those jurisdictions which allow the Priority zone to be used with smoke detectors.)
18(-)& 19(+)	Auxiliary power, regulated 12VDC, 500 mA maximum.
20	Earth Ground, connect to a cold water pipe or 6 to 10 foot driven rod.
21 & 22	AC input, connect a 16.5V 25 VA, Class II U.L. approved transformer. (included)
T1	House Telephone Tip (brown)
T	Telephone Tip (green)
R	Telephone Ring (red)
R1	House Telephone Ring (gray)
Battery Leads	Standby battery leads black(-) and red(+) connect to a 12VDC lead acid rechargeable battery. Do not connect to a dry cell battery.

PROGRAMMING

The Ranger 8600 can be placed into the "Program" mode by either of the following methods.

1. Enter the 4 digit "Go To Program" access code (locations 28-31). At initial power-up the code in these slots is [9][7][1][3]. The Ranger 8600 must be disarmed to gain access to programming with this code.
2. Plug the optional model #8950 programmer into the 4-pin male outlet marked "program" on the Ranger 8600 P.C. Board. See figure 3 on page 7.

When the system keypad is utilized for programming (as described by method 1 above), the Ranger 8600 will be in the "Program" mode, and the yellow LED's will display the data in location 000. The data is displayed using a Binary system. With this system the yellow zone 1 LED equals "1" when illuminated. The zone 2 LED equals "2" when illuminated. The zone 3 LED equals "4" when illuminated. The zone 4 LED equals "8" when illuminated. Thus if the data in location 000 is "9", the LED for zone 1 (=1) and zone 4 (=8) would be illuminated. By adding the two values together, (1+8=9) you would determine that the data in location 000 is "9". If the data in location 000 is "6", the LED for zone 2 (=2) and zone 3 (=4) would be added (2+4=6) indicating the data in that location to be "6". If no LED's are illuminated, the location contains a "0". To advance from location 000 through 180, press the [#] key. To go to a specific location, press the location number followed by the [#] key. The yellow LED's will then display the data in that location. Data is changed by entering a number 0 to 15 followed by [*] (* = data enter). Review the examples in figure 2 on page 7.

When using the optional #8950 Programmer, the programming keystrokes will be the same as with the system keypad. The #8950 however, has the ability to display the location number and the data on the numeric display. See figure 3 on page 7.

There are three function codes that are used to program the Ranger 8600. These are [2][1][0][#], [2][2][0][#], and [2][3][0][#] and are described below.

- After all the data has been entered into locations 000-180, you must enter the code [2][2][0][#] to permanently load the information into the EEPROM. **IF THIS STEP IS NOT TAKEN, THE DATA IN THE EEPROM WILL NOT CHANGE, AND THE RANGER 8600 WILL NOT CHANGE CHARACTERISTICS.**
- To change the Ranger 8600 data back to the original default values, enter the code [2][1][0][#] to load the data into the RAM memory and then [2][2][0][#] to load that data into the EEPROM.
- To exit the Program mode after it has been accessed with the four digit "Go To Program" access code, enter code [2][3][0][#].

PROGRAMMING EXAMPLE - FIGURE 2

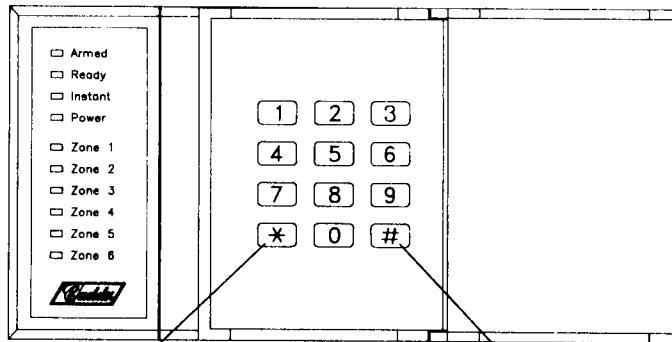
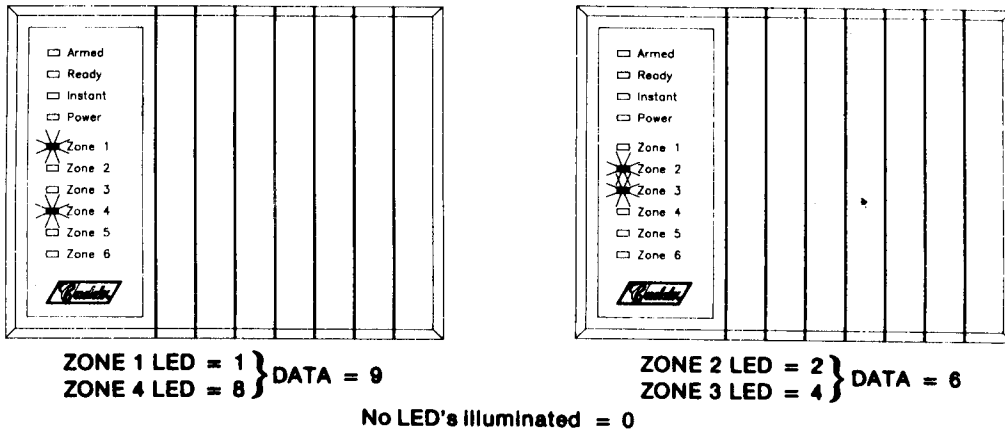

To change or enter data in location shown, enter data and follow by the * Key.

Pressing the # Key will advance to next location, or specific locations can be reached by pressing location number followed by the # Key.

#8950 PROGRAMMER - FIGURE 3

Current Location Indicator

1 Thru 0 Data Keys

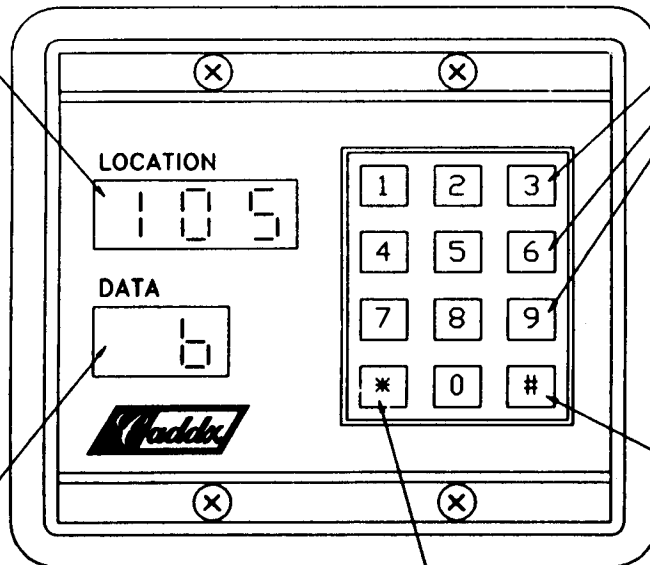

Current Data Indicator

Data Enter/Change key

Location Advance Key

PAGES 8 & 9 DESCRIBE ALL THE LOCATIONS WHICH MUST BE PROGRAMMED IN ORDER FOR THE RANGER 8600 TO FUNCTION AND REPORT TO A CENTRAL STATION. ADDITIONAL OPTIONS MAY BE SELECTED BY FOLLOWING THE PROGRAMMING INSTRUCTIONS ON PAGES 14 THRU 31.

LOCATIONS 032-047: PROGRAMMING THE PRIMARY TELEPHONE NUMBER

The primary telephone number is programmed in successive locations beginning with location 032. Any zero (0) within the telephone number, must be programmed as a "10". A "0" indicates the end of the phone number. Delays of four seconds can be programmed at any point in the phone number by programming a "13" in the appropriate location. If tone dialing is desired, program a "15" in the location where tone dialing should begin. If the entire number should be tone dialing, program a "15" in location 032. When using split reporting, the primary number always takes priority over the secondary telephone number.

LOCATIONS 048-051: PROGRAMMING THE ACCOUNT CODE FOR THE PRIMARY PHONE NUMBER

The account code sent when the PRIMARY phone number is dialed is programmed in locations 048-051. Any zero (0) within the account code must be programmed as a "10", and the communicator will report a zero (0). If the account code is three digits long, use locations 048, 049, and 050. Program a "0" to indicate the end of the account code.

LOCATION 052: PROGRAMMING COMMUNICATOR FORMAT FOR THE PRIMARY PHONE NUMBER

Location 052 contains the communicator format used to transmit to the receiver connected to the primary phone number. Consult the instructions for your central station receiver to determine which format is compatible. To select Ademco/Silent Knight Fast, program a "2" in location 052. Sescoa/Franklin Fast requires a "4" in this location, and Radionics 1800HZ/2300HZ Fast with parity and hex capability requires a "9" in this location. If you need another format, choose from those listed on the format table located on page 13 and program the data in location 052. If this location contains a "0", the built-in communicator will be disabled, and the Ranger 8600 will function as a local only control.

LOCATION 053: DISABLING THE SECONDARY TELEPHONE NUMBER AS A BACKUP

Location 053 is used to disable the secondary phone number as a "backup". This feature can be used with split reporting (locations 176-177) to prevent a report from going to the secondary telephone number after unsuccessful attempts to the primary phone number. If location 053 contains a "0", the secondary phone number will backup the primary, and the primary phone number will backup the secondary. If location 053 contains a "1", only the primary phone number will be called.

LOCATIONS 054-069: PROGRAMMING THE SECONDARY TELEPHONE NUMBER (SPLIT REPORTING)

Locations 054-069 contain the secondary telephone number. This number allows certain communicator reports to go to another number (split reporting), or to cause the communicator to dial a second number if the primary number does not respond after the number of attempts programmed into location 134 have been tried unsuccessfully. The same number of attempts are made with the back-up number. Tone dialing and delay instructions are the same as for the primary number.

LOCATIONS 070-073: PROGRAMMING THE ACCOUNT CODE FOR THE SECONDARY PHONE NUMBER

Locations 070-073 contain the account code for the secondary phone number. Any zero (0) within the account code must be programmed as a "10", and the communicator will report a zero (0). If the account code is three digits long, use locations 070, 071, and 072. Program a "0" to indicate the end of the account code. If these locations are left blank, the account code in locations 048-051 will be reported.

LOCATION 074: PROGRAMMING COMMUNICATOR FORMAT FOR THE SECONDARY TELEPHONE NUMBER

Location 074 contains the communicator format for the secondary phone number. Consult the instructions for your central station receiver to determine which format is compatible. To select Ademco/Silent Knight Fast, program a "2" in this location. Sescoa/Franklin Fast requires a "4" in this location, and Radionics 1800HZ/2300HZ Fast with parity and hex capability requires a "9" in this location. If you need another format, choose from those listed on the format table located on page 13 and program the appropriate data in this location. If location 074 is "0", the format programmed in location 052 will be used.

LOCATIONS 000-031 and 075-180 ARE ADDITIONAL OPTIONAL PROGRAMMING SLOTS TO CHANGE STANDARD DEFAULT COMMUNICATOR AND CONTROL FUNCTIONS FOR SECURITY SYSTEMS WITH NON-STANDARD REQUIREMENTS. THESE ARE EXPLAINED ON PAGES 14 THROUGH 31.

ARM/DISARM CODES

LOCATION	PAGE	DESCRIPTION	DATA	DATA	DATA	DATA	DEFAULT
0-3	14	USER 1 ARM/DISARM CODE <i>MASTER</i>					"1-2-3-4"
4-7	14	USER 2 ARM/DISARM CODE					"15" DISABLED
8-11	14	USER 3 ARM/DISARM CODE					"15" DISABLED
12-15	14	USER 4 ARM/DISARM CODE					"15" DISABLED
16-19	14	USER 5 ARM/DISARM CODE					"15" DISABLED
20-23	14	USER 6 ARM/DISARM CODE					"15" DISABLED
24-27	14	USER 7 ARM/DISARM CODE <i>HOSTAGE</i>					"15" DISABLED
28-31	14	"GO TO PROGRAM" ACCESS CODE <i>PROGRAM</i>					"9-7-1-3"

PHONE NUMBERS ACCOUNT CODE AND FORMAT

32-39	8	PRIMARY PHONE NUMBER DIGITS 1 - 8	1	8	10	10	?	?	?	?	"0" DISABLED
40-47	8	PRIMARY PHONE NUMBER DIGITS 9 - 16	?	?	?	0					"0" DISABLED
48-51	8	PRIMARY ACCOUNT CODE									"0" DISABLED
52	8	PRIMARY FORMAT							4		"0" DISABLED
53	8	SECONDARY PHONE NUMBER AS BACK UP									"0" ENABLED
54-61	9	SECONDARY PHONE NUMBER DIGITS 1 - 8	0								"0" DISABLED
62-69	9	SECONDARY PHONE NUMBER DIGITS 9 - 16	0								"0" DISABLED
70-73	9	SECONDARY ACCOUNT CODE							0		"0" DISABLED
74	9	SECONDARY FORMAT							0		"0" DISABLED

OPTIONAL CONTROL AND COMMUNICATOR FEATURES

LOCATION	PAGE	DESCRIPTION	DATA	DEFAULT
75	15	ENTRY TIME 1 (10 SECOND INCREMENTS)	3	"3" 30 SECONDS
76	15	EXIT TIME 1 (10 SECOND INCREMENTS)	6	"6" 60 SECONDS
77	15	SIREN SHUTDOWN/RECYCLE TIMEOUT (2 MINUTE INCREMENTS) <i>6 MIN</i>	3	"4" 8 MINUTES
78	15	ZONE 1 TYPE <i>1-DAY ZONE 2-24HR 3-1/1</i>	3	"3" ENTRY/EXIT
79	15	ZONE 2 TYPE <i>4-INTERIOR FOLLOWER</i>	5	"5" INTERIOR FOLLOWER
80	15	ZONE 3 TYPE <i>5-INST FOLLOWER</i>	6	"6" INSTANT
81	15	ZONE 4 TYPE <i>6-INST 7-20 MIN SILENT</i>	6	"6" INSTANT
82	15	ZONE 5 TYPE <i>8-PRIMARY</i>	6	"6" INSTANT
83	15	ZONE 6 TYPE <i>9-SECONDARY</i>	6	"6" INSTANT
84	15	RESERVED		RESERVED
85	15	RESERVED		RESERVED

COMMUNICATOR CODES

LOCATION	PAGE	DESCRIPTION	CODE	EXTENDED CODE	DEFAULTS
86-87	16	DURESS COMMUNICATOR CODE	2	7	"0" DISABLED
88-89	17	AUXILIARY 1 COMMUNICATOR CODE	4	8	"0" DISABLED
90-91	17	AUXILIARY 2 COMMUNICATOR CODE	1	8	"0" DISABLED
92-93	17	KEYPAD PANIC COMMUNICATOR CODE	2	8	"2 - 0"
94-95	17	TAMPER COMMUNICATOR CODE	0	0	"0" DISABLED
96-97	18	"DOWNLOADING COMPLETE" COMMUNICATOR CODE	0	0	"0" DISABLED

COMMUNICATOR CODES (CONTINUED)

LOCATION	PAGE	DESCRIPTION	CODES	EXTENDED CODE	DEFAULTS
98-99	18	AUTOTEST COMMUNICATOR CODE	0	0	"0" DISABLED
100-101	18	RESERVED			RESERVED
102	18	CLOSING COMMUNICATOR CODE	0	MAN NUMBER	"0" DISABLED
103	18	OPENING COMMUNICATOR CODE	0	MAN NUMBER	"0" DISABLED
104-105	19	ZONE 1 COMMUNICATOR CODE	3	1	"1 - 0"
106-107	19	ZONE 2 COMMUNICATOR CODE	3	2	"2 - 0"
108-109	19	ZONE 3 COMMUNICATOR CODE	3	3	"3 - 0"
110-111	19	ZONE 4 COMMUNICATOR CODE	3	4	"4 - 0"
112-113	19	ZONE 5 COMMUNICATOR CODE	3	5	"5 - 0"
114-115	19	ZONE 6 COMMUNICATOR CODE	3	6	"6 - 0"
116-119	20	RESERVED			RESERVED
120-121	20	AC POWER LOSS COMMUNICATOR CODE	7	9	"0" DISABLED
122-123	20	LOW BATTERY COMMUNICATOR CODE <i>Smoke 7(26)</i>	7	8	"0" DISABLED
124	20	TROUBLE COMMUNICATOR CODE	0	ZONE NUMBER	"0" DISABLED
125	20	ZONE BYPASS COMMUNICATOR CODE <i>Smoke 8(36)</i>	0	ZONE NUMBER	"0" DISABLED
126	20	RESTORE COMMUNICATOR CODE	0	ZONE NUMBER	"0" DISABLED
127	21	CANCEL COMMUNICATOR CODE	0	MAN NUMBER	"0" DISABLED

OPTIONAL CONTROL AND COMMUNICATOR FEATURES

LOCATION	PAGE	DESCRIPTION	DATA	DEFAULT
128	21	ABORT COMMUNICATOR CODE	0	"0" DISABLED
129	21	KEYPAD HOLDUP/PANIC AUDIBLE	0	"0" AUDIBLE
130	21	NUMBER OF ALARMS FOR SWINGER SHUTDOWN	5	"0" DISABLED
131	21	AUTO BYPASS/INSTANT ARMING <i>1 = N/A INST DKS 3 = 100% SW PRA</i>		"0" DISABLED
132	22	SIREN DRIVER/VOLTAGE OUT	0	"0" SIREN
133	22	L.E.D. EXTINGUISH	0	"0" DISABLED
134	22	DIAL ATTEMPTS	8	"8" EIGHT ATTEMPTS
135	22	POWER UP CONDITION	0	"0" LAST CONDITION
136	22	POWER UP DELAY	0	"0" 60 SEC DELAY
137	22	IMMEDIATE RESTORE BY ZONE	0	"0" DISABLED
138	22	NO ARMING WITH A ZONE BYPASSED	0	"0" DISABLED
139	23	QUICKARM DIGIT	0	"0" DISABLED
140	23	PRIORITY SIREN CUTOFF INHIBIT	0	"0" RECYCLES
141	23	DOUBLE LINE EXTENDED	0	"0" DISABLED
142	23	SIREN/BELL TEST	0	"0" DISABLED
143	23	RESETTABLE AUXILIARY POWER	1	"1" POWER RESET
144	23	EUROPEAN PULSE DIAL RATIO	0	"0" DISABLED
145	24	AUXILIARY OUTPUT 1	0	"0" ARMED
146	24	AUXILIARY OUTPUT 2	1	"1" READY
147	24	AUXILIARY OUTPUT 3	2	"2" BURG/PANIC SIREN
148	24	AUXILIARY OUTPUT 4	3	"3" FIRE SIREN
149	24	AUXILIARY OUTPUT INVERSION	0	"0" HIGH GOING LOW

OPTIONAL CONTROL AND COMMUNICATOR FEATURES (CONTINUED)

LOCATION	PAGE	DESCRIPTION	DATA	DEFAULT
150	24	AC POWER LOSS DELAY	0	"0" DELAYED
151	24	NUMBER OF RINGS TO ANSWER DOWNLOAD CALL	8	"8" 8 RINGS
152	25	DAYS LEFT UNTIL AUTOTEST REPORT		UNDEFINED
153	25	CURRENT MONTH		UNDEFINED
154	25	CURRENT YEAR-TENS DIGIT		UNDEFINED
155	25	CURRENT YEAR-ONES DIGIT		UNDEFINED
156	25	CURRENT DAY-TENS DIGIT		UNDEFINED
157	25	CURRENT DAY-ONES DIGIT		UNDEFINED
158	25	CURRENT HOUR-TENS DIGIT		UNDEFINED
159	25	CURRENT HOUR-ONES DIGIT		UNDEFINED
160	26	CURRENT MINUTES-TENS DIGIT		UNDEFINED
161	26	CURRENT MINUTES-ONES DIGIT		UNDEFINED
162	26	AUTOTEST REPORT HOUR-TENS DIGIT		"0"
163	26	AUTOTEST REPORT HOUR-ONES DIGIT		"0"
164	26	AUTOTEST REPORT MINUTES-TENS DIGIT		"0"
165	26	AUTOTEST REPORT MINUTES-ONES DIGIT		"0"
166	27	AUTOTEST REPORT INTERVAL		"0"
167	27	ROTATING MAINTENANCE CODE	0	"0" DISABLED
168	27	COMPLEX/SEED CODE DIGIT 1	0	"0"
169	27	COMPLEX/SEED CODE DIGIT 2	0	"0"
170	27	COMPLEX/SEED CODE DIGIT 3	0	"0"
171	27	COMPLEX/SEED CODE DIGIT 4	0	"0"
172	27	USER #7 (MAINTENANCE CODE) OPENING COMMUNICATOR CODE	0	"0" DISABLED
173	27	USER #7 (MAINTENANCE CODE) CLOSING COMMUNICATOR CODE	0	"0" DISABLED
174	28	ZONES 3-4-5-6 EOL RESISTOR DEFEAT	0	"0" SUPERVISED
175	29	ZONES 1-2 EOL RESISTOR DEFEAT	0	"0" SUPERVISED
176	29	TAMPER, DL COMPLETE, AUTOTEST, SPLIT REPORTING	0	"0" PHONE NUMBER 1
177	30	AC FAIL, LOW BATT, OPEN/CLOSE, MAINT OPEN/CLOSE, SPLIT REPORT	0	"0" PHONE NUMBER 1
178	30	SECONDARY ENTRY TIME (10 SECOND INCREMENTS) 1:10 Sec		"0" INSTANT
179	31	SECONDARY EXIT TIME (10 SECONDS INCREMENTS) 1:10 Sec		"0" EXIT TIME 1
180	31	LOOP RESPONSE TIME	0	"0" 500 MS
181-185	31	RESERVED		RESERVED

REMEMBER: AFTER ALL DATA HAS BEEN ENTERED, PRESS [2][2][0][#] TO STORE DATA IN EEPROM!

DOWNLOADING ACCESSIBLE LOCATIONS

186-193	31	CONTROL PANEL ACCESS CODE									"86000000"
194-201	31	CALLBACK PHONE NUMBER DIGITS 1-8									"0" DISABLED
202-209	31	CALLBACK PHONE NUMBER DIGITS 9-16									"0" DISABLED
210	31	ANSWERING MACHINE DEFEAT									"0" DISABLED
211	31	LOCAL PROGRAMMING LOCKOUT									"0" NOT LOCKED
212	31	CONTROL PANEL SHUTDOWN									"0" CONTROL ON

COMMUNICATOR FORMAT SELECTIONS

DATA	FORMAT	DESCRIPTION
"0"	LOCAL ONLY	THE COMMUNICATOR IS DISABLED
"1"	ADEMCO/SILENT KNIGHT SLOW	1900HZ TRANSMIT 1400HZ HANDSHAKE DOUBLE ROUND PARITY 10 PPS
"2"	ADEMCO/SILENT KNIGHT FAST	1900HZ TRANSMIT 1400HZ HANDSHAKE DOUBLE ROUND PARITY 20 PPS
"3"	SESCOA/FRANKLIN SLOW	1800HZ TRANSMIT 2300HZ HANDSHAKE DOUBLE ROUND PARITY 10 PPS
"4"	SESCOA/FRANKLIN FAST	1800HZ TRANSMIT 2300HZ HANDSHAKE DOUBLE ROUND PARITY 20 PPS
"5"	EXTENDED RADIONICS SLOW	1800HZ TRANSMIT 2300HZ HANDSHAKE DOUBLE ROUND PARITY 20 PPS EXTENDED HEX CAPABILITY
"6"	EXTENDED RADIONICS SLOW	1800HZ TRANSMIT 1400HZ HANDSHAKE DOUBLE ROUND PARITY 20 PPS EXTENDED HEX CAPABILITY
"7"	EXTENDED RADIONICS FAST	1800HZ TRANSMIT 2300HZ HANDSHAKE DOUBLE ROUND PARITY 40 PPS EXTENDED HEX CAPABILITY
"8"	EXTENDED RADIONICS FAST	1800HZ TRANSMIT 1400HZ HANDSHAKE DOUBLE ROUND PARITY 40 PPS EXTENDED HEX CAPABILITY
"9"	EXTENDED RADIONICS FAST WITH PARITY	1800HZ TRANSMIT 2300HZ HANDSHAKE SINGLE ROUND WITH PARITY 40PPS EXTENDED HEX CAPABILITY
A ="10"	EXTENDED RADIONICS FAST WITH PARITY	1800HZ TRANSMIT 1400HZ HANDSHAKE SINGLE ROUND WITH PARITY 40PPS EXTENDED HEX CAPABILITY
B ="11"	SILENT KNIGHT 4+2 SLOW	1900HZ TRANSMIT 1400HZ HANDSHAKE DOUBLE ROUND PARITY FOUR-TWO 10PPS
C ="12"	SILENT KNIGHT 4+2 FAST	1900HZ TRANSMIT 1400HZ HANDSHAKE DOUBLE ROUND PARITY FOUR-TWO 20PPS
D ="13"	RADIONICS NON-EXTENDED	1800HZ TRANSMIT 2300HZ HANDSHAKE DOUBLE ROUND PARITY 20 PPS HEX CAPABILITY
E ="14"	RADIONICS NON-EXTENDED	1800HZ TRANSMIT 1400HZ HANDSHAKE DOUBLE ROUND PARITY 20 PPS HEX CAPABILITY
F ="15"	ADEMCO/SILENT KNIGHT FAST HEX	1900HZ TRANSMIT 1400HZ HANDSHAKE DOUBLE ROUND PARITY 20 PPS HEX CAPABILITY

LOCATIONS 000-003: PROGRAMMING THE MASTER ARM/DISARM CODE

Locations 000-003 contain master arm/disarm code (user number 1). Location 000 contains the first digit of the code; location 003 contains the fourth digit of the code. THE CODE MUST CONTAIN FOUR (4) DIGITS. The master code can then be used in the run mode to enter arm/disarm codes 1-7 (see page 32, ENTERING AND CHANGING THE MASTER CODE). The factory default code is [1][2][3][4].

LOCATIONS 004-007: PROGRAMMING THE ARM/DISARM CODE FOR USER 2

Locations 004-007 contain the arm/disarm codes for user number 2. Location 004 contains the first digit of the code, location 007 contains the fourth digit of the code. THE CODE MUST CONTAIN FOUR (4) DIGITS. To disable a code PROGRAM a "15" as the first digit of the code. This code can be changed in the RUN mode using the master code (see page 33, ENTERING AND CHANGING AUXILIARY CODES). The factory default for user 2 is disabled.

LOCATIONS 008-023: PROGRAMMING THE ARM/DISARM CODE FOR USERS 3-6:

Locations 008-023 contain the arm/disarm codes for user numbers 3-6. To program these codes follow the instructions for user number 2 corresponding to the following table:

USER NUMBER	LOCATION	COMMENTS
3	008-011	Can be changed in the run mode
4	012-015	Can be changed in the run mode
5	016-019	Can be changed in the run mode
6	020-023	Can be changed in the run mode

LOCATIONS 024-027: PROGRAMMING THE DURESS CODE OR USER 7

Locations 024-027 contain the arm/disarm code for Duress or for user number 7. Duress capability is enabled by programming a communicator code in locations 086-087. If locations 086-087 are left unprogrammed, user number 7 will act as a standard user code. If the maintenance code option is selected in location 167, locations 024-027 should not be programmed.

LOCATIONS 028-031: PROGRAMMING THE "GO TO PROGRAM" ACCESS CODE

Locations 028-031 contain the "Go To Program" access code. Location 028 contains the first digit of the code and location 031 contains the fourth digit of the code. THE CODE MUST CONTAIN FOUR (4) DIGITS. With the Ranger 8600 disarmed, the "Go To Program" access code can be used to enter the program mode. To disable the "Go To Program" access code, program a "15" in location 028. The factory default setting is [9][7][1][3].

LOCATIONS 032-074: SEE PAGES 8 & 9

LOCATION 075: PROGRAMMING THE ENTRY DELAY TIME

Location 075 contains the number of 10 second increments in the entry delay. The entry delay can be programmed in 10 second increments from 10 to 150 seconds ("1" = 10 seconds through "15" = 150 seconds). For example, programming a "2" in this location will produce an entry delay of 20 seconds. (Note: A "0" entry is treated as 0 seconds). Programming a "6" in this location will produce an entry delay of 60 seconds. Factory default is 30 seconds.

LOCATION 076: PROGRAMMING THE EXIT DELAY TIME

Location 076 contains the number of 10 second increments in the exit delay. The exit delay can be programmed in 10 second increments from 10 to 150 seconds ("1" = 10 seconds through "15" = 150 seconds). For example, programming a "2" in this location will produce an exit delay of 20 seconds. (Note: A "0" entry is treated as 0 seconds). Programming a "6" in this location will produce an exit delay of 60 seconds. Factory default is 60 seconds.

LOCATION 077: PROGRAMMING THE SIREN SHUTDOWN/RECYCLE TIMEOUT

Location 077 contains the number of 2 minute increments in the automatic cutoff time. The automatic cutoff time can be programmed in 2 minute increments from 2 to 30 minutes ("1" = 2 minutes through "15" = 30 minutes). For example, programming a "2" in this location will produce an automatic cutoff time of 4 minutes. (Note: A "0" entry is treated as the factory default of 8 minutes.) Programming a "6" in this location will produce an automatic cutoff time of 12 minutes.

LOCATIONS 078-083: PROGRAMMING THE ZONE TYPES

Locations 078 through 083 contain a number identifying the characteristics of each of the 6 zones. Location 078 corresponds to zone 1 and location 083 corresponds to zone 6. Each zone will factory default according to the following list:

ZONE NUMBER	DEFAULT CHARACTERISTIC
ZONE 1	"3"=ENTRY/EXIT DELAY
ZONE 2	"5"=INTERIOR FOLLOWER
ZONE 3	"6"=INSTANT
ZONE 4	"6"=INSTANT
ZONE 5	"6"=INSTANT
ZONE 6	"6"=INSTANT

To program zone characteristics other than the default values, program a number from "1" to "9" based on the characteristics found in the list on the following page.

LOCATIONS 084-085: RESERVED FOR FUTURE USE

NUMBER	ZONE CHARACTERISTICS DESCRIPTION
"1"	DAY ZONE - A trip on a Day zone will produce an instant alarm when armed and activate the keypad sounder when disarmed.
"2"	24 HOUR - A trip on a 24 Hour zone will produce an instant alarm when the Ranger 8600 is armed or disarmed.
"3"	ENTRY/EXIT - A trip will start entry delay. The lack of a trip during exit delay will enable the "Automatic Bypass" or "Instant" mode if so programmed.
"4"	INTERIOR DELAY - A trip on Interior Delay zone will initiate an entry delay. It will be ignored during exit delay and when disarmed .
"5"	INTERIOR FOLLOWER - Interior zone that follows the delay zones. It is instant during non-delay times. It can be bypassed before arming, or by allowing it to automatically be bypassed in the "Automatic Bypass/Instant" mode if so programmed.
"6"	INSTANT - Produces an instant alarm when tripped in the armed mode. It is ignored when disarmed.
"7"	24 HOUR SILENT - A trip on a 24 hour silent zone will communicate to the central station when the Ranger 8600 is armed or disarmed.
"8"	PRIORITY - A short on a Priority zone type will communicate to the central station when the Ranger 8600 is armed or disarmed. Priority zones cannot be bypassed.
"9"	SECONDARY DELAY - A secondary delay zone works like an interior delay zone but has its own independent delay time (see locations 178-179).

NOTE: WHEN PROGRAMMING THE FOLLOWING COMMUNICATOR CODES, A "10" MUST BE PROGRAMMED IN ORDER TO REPORT A ZERO (0).

LOCATION 086-087: PROGRAMMING THE RANGER 8600 FOR DURESS CODE CAPABILITY

The Ranger 8600 has the ability to report a duress code when the system is armed or disarmed with user code number 7 and a duress communicator code is programmed in locations 086-087. If both locations are "0", the duress capability is disabled and user code number 7 can only be used as a standard arm/disarm code. Location 086 contains the standard digit, and location 087 contains the extended digit. When using 4+2 format, the number programmed in location 086 is sent as the second, or "ones" digit. The first, or "tens" digit is programmed in location 087. **NOTE: ENABLING THE MAINTENANCE CODE FEATURE IN LOCATION 167 WILL AUTOMATICALLY DISABLE THE DURESS FEATURE**

LOCATION 088-089: PROGRAMMING FOR AUXILIARY 1

The Ranger 8600 has the ability to report an Auxiliary 1 code and activate the Priority siren each time the [1] and [3] keys are pressed simultaneously on the keypad. The desired reporting code is programmed in locations 088-089. If both locations are "0", the Auxiliary 1 double keypress is disabled. Location 088 contains the standard digit, and location 089 contains the extended digit. When using a 4+2 format, the number programmed in location 088 is sent as the second, or "ones" digit. The first, or "tens" digit is programmed in location 089. If activated, the siren can be silenced by entering any arm/disarm code.

LOCATION 090-091: PROGRAMMING FOR AUXILIARY 2

The Ranger 8600 has the ability to report an Auxiliary 2 code and activate the pulsing buzzer each time the [4] and [6] keys are pressed simultaneously on the keypad. The desired Auxiliary 2 code is programmed in locations 090-091. If both locations are "0", the Auxiliary 2 double keypress is disabled. Location 090 contains the standard digit, and location 091 contains the extended digit. When using 4+2 format, the number programmed in location 090 is sent as the second, or "ones" digit. The first, or "tens" digit is programmed in location 091. If activated, the keypad sounder can be silenced by entering any Arm/Disarm code.

LOCATION 092-093: PROGRAMMING FOR KEYPAD PANIC

The Ranger 8600 has the ability to report a Keypad panic code and activate the Burg siren each time the [*] and [#] keys are pressed simultaneously on the keypad. The desired Keypad panic code is programmed in locations 092-093. If both locations are "0", the Keypad panic double keypress is disabled. Location 092 contains the standard digit, and location 093 contains the extended digit. When using 4+2 format, the number programmed in location 092 is sent as the second, or "ones" digit. The first, or "tens" digit is programmed in location 093. If activated, the siren can be silenced by entering any Arm/Disarm code.

LOCATION 094-095: PROGRAMMING THE TAMPER FEATURE

The Ranger 8600 has an optional tamper feature that, when enabled, will lock out the keypads for 1 minute if 30 random keypresses are made without producing a valid code. The desired tamper code should be programmed in locations 094-095. If the control is not programmed for local only, the tamper will be communicated. If both locations are "0", the tamper feature will not be enabled or reported. Location 094 contains the standard digit, and location 095 contains the extended digit. When using 4+2 format, the number programmed in location 094 is sent as the second, or "ones" digit. The first, or "tens" digit is programmed in location 095.

LOCATION 096-097: PROGRAMMING TO REPORT DOWNLOADING COMPLETE

Locations 096-097 contain the communicator report sent each time a download session has been completed. The report will come in after a disconnect has been made from a downloading session. Location 096 contains the standard communicator code, and location 097 contains the extended communicator code. When using a 4+2 format, the number programmed in location 096 is sent as the second, or "ones" digit. The number programmed in location 097 is sent as the first, or "tens" digit. When using an extended format, the extended report will be sent if location 097 contains a number other than "0". If locations 096-097 are "0", this report is disabled.

LOCATION 098-099: PROGRAMMING FOR AUTOTEST REPORTS

The Ranger 8600 has the ability to send autotest reports at intervals from 1 to 15 days. Locations 098-099 contain the communicator codes sent for autotest. Location 098 contains the standard communicator code, and location 099 contains the extended communicator code. When using a 4+2 format, the number programmed in location 098 is sent as the second, or "ones" digit. The number programmed in location 099 is sent as the first, or "tens" digit. When using an extended format, the extended report will be sent if location 099 contains a number other than "0". If locations 098-099 are "0", autotest is disabled. (NOTE: WHEN USING AUTOTEST, LOCATIONS 152-166 MUST BE PROGRAMMED.)

LOCATION 100-101: RESERVED FOR FUTURE USE

LOCATION 102: PROGRAMMING TO REPORT CLOSINGS

The Ranger 8600 has the ability to report a closing code each time the control is armed. The desired closing code is programmed in location 102. If this location contains a "0", closings will not be reported. When using 4+2 format, the number programmed in this location is sent as the first, or "tens" digit. The second, or "ones" digit is automatically the man number. When using the remote arming input, the man number is 1. When using a one button "Quick Arm" code the man number is 1. The closing report will not be initiated until the end of the exit delay.

LOCATION 103: PROGRAMMING TO REPORT OPENINGS

The Ranger 8600 has the ability to report an opening code each time the control is disarmed. The desired opening code is programmed in location 103. If this location contains "0", openings will not be reported. When using 4+2 format, the number programmed in this location is sent as the first, or "tens" digit.

er is 1. remote arming input, the man

LOCATION 104-105: PROGRAMMING THE COMMUNICATOR CODE FOR ZONE 1

Locations 104-105 contain the communicator code to be reported each time zone 1 creates an alarm. Location 104 contains the standard digit, and location 105 contains the extended digit. When using 4+2 format, the number programmed in location 104 is sent as the second, or "ones" digit. The first, or "tens" digit is programmed in location 105.

LOCATION 106-107: PROGRAMMING THE COMMUNICATOR CODE FOR ZONE 2

Locations 106-107 contain the communicator code to be reported each time zone 2 creates an alarm. Location 106 contains the standard digit, and location 107 contains the extended digit. When using 4+2 format, the number programmed in location 106 is sent as the second, or "ones" digit. The first, or "tens" digit is programmed in location 107.

LOCATION 108-109: PROGRAMMING THE COMMUNICATOR CODE FOR ZONE 3

Locations 108-109 contain the communicator code to be reported each time zone 3 creates an alarm. Location 108 contains the standard digit, and location 109 contains the extended digit. When using 4+2 format, the number programmed in location 108 is sent as the second, or "ones" digit. The first, or "tens" digit is programmed in location 109.

LOCATION 110-111: PROGRAMMING THE COMMUNICATOR CODE FOR ZONE 4

Locations 110-111 contain the communicator code to be reported each time zone 4 creates an alarm. Location 110 contains the standard digit, and location 111 contains the extended digit. When using 4+2 format, the number programmed in location 110 is sent as the second, or "ones" digit. The first, or "tens" digit is programmed in location 111.

LOCATION 112-113: PROGRAMMING THE COMMUNICATOR CODE FOR ZONE 5

Locations 112-113 contain the communicator code to be reported each time zone 5 creates an alarm. Location 112 contains the standard digit, and location 113 contains the extended digit. When using 4+2 format, the number programmed in location 112 is sent as the second, or "ones" digit. The first, or "tens" digit is programmed in location 113.

LOCATION 114-115: PROGRAMMING THE COMMUNICATOR CODE FOR ZONE 6

Locations 114-115 contain the communicator code to be reported each time zone 6 creates an alarm. Location 114 contains the standard digit, and location 115 contains the extended digit. When using 4+2 format, the number programmed in location 114 is sent as the second, or "ones" digit. The first, or "tens" digit is programmed in location 115.

LOCATION 116-119: RESERVED FOR FUTURE USE

LOCATION 120-121: PROGRAMMING TO REPORT AC POWER LOSS

The Ranger 8600 has the ability to report an AC power failure code after the AC power has been off for 5 minutes. The desired AC failure mode is programmed in locations 120-121. If both locations are "0", AC power failure will not be reported. Location 120 contains the standard digit, and location 121 contains the extended digit. When using 4+2 format, the number programmed in location 120 is sent as the second, or "ones" digit. The first, or "tens" digit is programmed in location 121.

LOCATION 122-123: PROGRAMMING TO REPORT LOW BATTERY

The Ranger 8600 has the ability to report a low battery code when AC power has been lost and the battery has discharged down to 10.3 volts. The desired low battery code is programmed in locations 122-123. If both locations are "0", low battery will not be reported. Location 122 contains the standard digit, and location 123 contains the extended digit. When using 4+2 format, the number programmed in location 122 is sent as the second, or "ones" digit. The first, or "tens" digit is programmed in location 123.

LOCATION 124: PROGRAMMING FOR PRIORITY ZONE TYPE TROUBLE REPORTING

The Ranger 8600 has the ability to report a trouble code each time a Priority zone opens. The desired trouble code is programmed in location 124. If this location contains a "0", the Priority Trouble will not be reported.

LOCATION 125: PROGRAMMING FOR ZONE BYPASS REPORTING

The Ranger 8600 has the ability to report a bypass on zones 1-6. The desired bypass code is programmed in location 125. If this location contains a "0", zone bypass will not be reported. When using 4+2 format, the number programmed in this location is sent as the first, or "tens" digit. The second, or "ones" digit is the zone communicator code. The bypass will be reported at the end of the exit delay for non-24 hour zones. 24 hour zones will report a bypass immediately. When a bypass is removed, a restore will be reported if "Restore" is enabled in location 126.

LOCATION 126: PROGRAMMING THE COMMUNICATOR CODE FOR RESTORAL

Location 126 contains the communicator code that will be sent for restoral of a zone. If this location contains a "0", no restorals will be reported. If a restoral code is programmed and an extended format is selected, the restorals will be reported by zone. If a restoral code is programmed and an extended format is not selected, a restoral code will be sent when all of the previously reported conditions have restored. When using 4+2 format, the number programmed in this location is sent as the first, or "tens" digit. The second, or "ones" digit will be the "ones" digit of the zone or condition that restored.

LOCATION 127: PROGRAMMING THE COMMUNICATOR CODE FOR CANCEL (EXCEPTION OPENING)

Location 127 contains the communicator code that will be sent for cancel. The cancel code programmed in this location will be sent if an arm/disarm code is entered after a trip on zones 1 through 6 has been reported (excluding 24 hour zones). After a cancel has been reported, no loop restorals will be transmitted on non-24 Hour zones. If this location contains a "0", cancel is disabled. When using 4+2 format, the number programmed in this location is sent as the first, or "tens" digit. The second, or "ones" digit is the man number of the person that cancelled. When using a remote arming input, the man number is 1.

LOCATION 128: PROGRAMMING THE COMMUNICATOR TO ABORT

Location 128 is used to enable the communicator abort. A "1" in this location will cause the Ranger 8600 to abort the report of a trip on any non-24 hour zone, if an arm/disarm code is entered prior to central station connection. If this location contains a "0", the Ranger 8600 will not abort any reports.

LOCATION 129: PROGRAMMING FOR SILENT PANIC/HOLD-UP

Location 129 is used to silence the audible output for a panic/hold-up alarm. Programming a "1" in this location will silence the audible output during a panic/hold-up alarm. If this location contains a "0", the Ranger 8600 will have an audible panic/hold-up output.

LOCATION 130: ENABLING THE SWINGER SHUTDOWN

Location 130 is used to enable the burglary zone swinger shutdown. The number programmed in this location, will determine the number of trips the Ranger 8600 will allow, before bypassing all burglary zones (1-6) which have tripped during an arming cycle. The bypassed zones will not report trips to a central station, and the local siren or bell will not sound for these zones. A zone trip will not be added to the number count until after the zone has tripped more than once. If this location contains a "0", this feature is disabled. A zone which has been bypassed by this feature will be reported if bypass reporting is enabled in location 125.

LOCATION 131: AUTOMATIC BYPASS / INSTANT ARMING

Location 131 is used to enable automatic "Instant Arming". Programming a "1" in this location will cause the control to automatically enter the "Instant" mode and bypass interior follower zones if a fault is not detected on an entry/exit zone during the exit delay. Programming a "3" in this location (Automatic Bypass), will cause the interior follower zones to become bypassed if a fault is not detected on an entry/exit zone, yet will not change the status of the entry/exit zone. If this location contains a "0", these features are disabled. Pressing the [*] key when the system is armed, will cause the "Instant" light to toggle. When the "Instant" light is on, the entry/exit zone is instant; when off, the entry/exit zone is delayed. The [*] key will toggle the "Instant" mode regardless of the programming data in this location.

LOCATION 132: BUILT-IN SIREN DRIVER / 1 AMP VOLTAGE OUTPUT

The built-in siren driver has a steady sound (for Priority zone type), and a yelp sound (for Burglary and Panic). Factory default is "0", enabling this feature. If the built-in siren driver is NOT to be used, take the following procedure. First, remove the jumper on the PC board. Next, program a "1" in location 132. Finally, replace the jumper in the voltage position. Terminals 14 & 15 will now output 1 Amp at 12VDC.

LOCATION 133: L.E.D. EXTINGUISH FEATURE

Keypad LEDs (with the exception of the A.C. LED) will be extinguished after 60 seconds of keypad inactivity, if a "1" is programmed in location 133. The LEDs will become illuminated immediately upon a keypress or alarm condition.

LOCATION 134: ENTERING THE NUMBER OF DIAL ATTEMPTS

Location 134 is used to enter the number of dial attempts (1 to 15 attempts) the communicator will try for the appropriate phone number(s) before ending the notification process. If this location contains an "8", the communicator will make 8 attempts to the first number, and then eight attempts to a second number, if a second number is programmed as backup.

LOCATION 135: POWER UP CONDITION

If a "1" is programmed in location 135, the Ranger 8600 will power-up disarmed if there is a total power shutdown and battery failure. If a "2" is programmed in this location, it will power up armed. If this location contains a "0", the Ranger 8600 will maintain the condition it was in at power down. A watchdog circuit reset will cause the Ranger 8600 to reset to the selected condition.

LOCATION 136: POWER UP DELAY

If a one "1" is programmed in location 136, the Ranger 8600 will not delay 60 seconds before accepting open or short inputs from any zone. If a "0" is programmed, sensors on all zones are allowed 60 seconds to stabilize at power-up, or after exiting the program mode. After 60 seconds, the Ranger will once again accept loop opens or shorts as an alarm condition. This 60 second period will also be initiated after a watchdog circuit reset condition.

LOCATION 137: IMMEDIATE RESTORE BY ZONE

If a "1" is programmed in location 137, restoral signals will follow the restore condition and report restores immediately after the condition has unfaulted. A non-extended format will not send a restore message until all zones and trouble conditions have restored. If this location contains a "0", the restore signal or signals will be reported only after siren timeout.

LOCATION 138: NO ARMING WITH A ZONE BYPASSED

If a "1" is programmed in location 138, the Ranger 8600 will not arm with any zone bypassed. If programmed with a "0", up to 5 of the 6 burglary zones can be bypassed, and the Ranger 8600 can still be armed.

LOCATION 139: PROGRAMMING THE QUICK ARM DIGIT

The Ranger 8600 can be programmed to "Quick Arm" with one digit by programming a digit (1-9) in location 139. A "0" in this location will disable this feature. If the "Quick Arm" digit is the same as the first digit of the Master code (user 1), the "Door Chime Annunciation" feature will not function.

LOCATION 140: PRIORITY SIREN CUTOFF INHIBIT

If a "1" is programmed in location 140, a Priority zone type siren will sound continuously until an arm/disarm code is entered. If this location contains a "0", the Priority zone type siren will shutdown after the amount of time programmed in location 077 has elapsed. Programming in this location does not affect the burglary siren.

LOCATION 141: DOUBLE LINE EXTENDED ALARM REPORTING

If an extended format is selected in location 052, and a "1" is programmed location 141, all reports will be double line extended. If location 141 contains a "0", only non-alarm reports will be extended (restore, cancel, opening, closing, bypass, and trouble). With this format, the central station will receive the report on two printed lines. The example below shows a burglary report from zone 6 of account number 999. Zone 6 was programmed to report a 3.

LINE 1:	999	3
	(ACCOUNT CODE)	(EXTENDED CODE)
LINE 2:	333	6
	(EXTENDED CODE 3 TIMES)	(ZONE CODE)

LOCATION 142: SIREN/BELL TEST FEATURE

Programming a "1" in location 142 will cause the siren/bell to come on each time the [1] and [7] keys are pressed simultaneously. The siren/bell can be silenced with an arm/disarm code. The siren/bell test does not cause the communicator to transmit a message.

LOCATION 143: RESETTABLE AUXILIARY POWER

Programming a "1" in location 143 will cause the 8600 (when in the disarmed state) to interrupt the smoke detector power each time the [#] button is pressed. If this location contains a "0", the smoke detector power will reset only after the [#] button is pressed when zone(s) designated as Priority zone types are on steady for alarm or blinking for trouble.

LOCATION 144: EUROPEAN PULSE DIAL RATIO

Programming a "1" in location 144 will change the pulse dialing make/break ratio and interdigit spacing to conform to most European telecom standards.

LOCATION 145-148: PROGRAMMING THE AUXILIARY OUTPUTS

The 8600 has 4 auxiliary outputs located in a pin connector on the left side of the control PC board. These outputs can be activated by 10 different conditions. To utilize the outputs, program a number from "0" to "9" in locations 145 (output 1) to location 148 (output 4) according to the desired characteristics listed below. Output 1 is the bottom pin and output 4 is the top pin.

PROGRAMMED DIGIT	ACTIVATION ON	NOTES
"0"	ARMED STATE	LATCHED OUTPUT
"1"	READY	LATCHED OUTPUT
"2"	BURG/PANIC SIREN	RECYCLED OUTPUT
"3"	PRIORITY SIREN	RECYCLED OUTPUT
"4"	ARMED WITH BYPASS	LATCHED OUTPUT
"5"	AC POWER	LATCHED OUTPUT
"6"	LOW BATTERY	LATCHED OUTPUT
"7"	ALARM MEMORY	LATCHED OUTPUT
"8"	ENTRY	LATCHED OUTPUT
"9"	EXIT	LATCHED OUTPUT

LOCATIONS 149: INVERTING THE AUXILIARY OUTPUTS

The auxiliary outputs of the 8600 are normally POSITIVE (+) going NEGATIVE (-). They can be changed to a normally NEGATIVE (-) going POSITIVE (+) by programming the appropriate number in location 149. Auxiliary output 1 has a value of "1", Auxiliary output 2 has a value of "2", Auxiliary output 3 has a value of "4", and Auxiliary output 4 has a value of "8". The values for the outputs that you wish to change to NEGATIVE going POSITIVE must be added together and the total programmed in location 149. For example, if you wished to make outputs 2 ="2" and 3 ="4" NEGATIVE going POSITIVE, you would program "6" (2+4=6) in location 149. NOTE: CURRENT LIMITED TO 250 MICRO AMPS POSITIVE AND 20 mA NEGATIVE.

LOCATION 150: AC POWER LOSS DELAY FEATURE

Location 150 is used to disable the 5 minute delay before reporting an AC power failure. If a "1" is programmed in this location, AC power failures will be reported immediately. If a "0" is programmed in this location, AC power failures will not be reported until the power has been off for 5 minutes.

LOCATION 151: PROGRAMMING THE NUMBER OF RINGS TO ANSWER DOWNLOAD CALL

Location 151 contains the number of rings the 8600 must detect before answering the telephone when initiating a download. If a number from "1" to "15" is programmed in this location, the control will answer after THAT number of rings has been detected. If a "0" is programmed in this location, the 8600 will not answer the download call. (SEE LOCATION 212: ANSWERING MACHINE DEFEAT)

LOCATION 152: PROGRAMMING THE NUMBER OF DAYS LEFT UNTIL AUTOTEST REPORT

Location 152 contains the number of days left until the next autotest report. If this location contains a "0", an autotest signal will be reported the first time the current time equals the autotest time programmed in locations 162-165. Locations 098-099 must be programmed to enable autotest reporting.

LOCATION 153: PROGRAMMING THE CURRENT MONTH

Location 153 contains the current month. The month must be programmed using a number from "1" to "12". This location must be programmed when using the maintenance code feature (see location 167).

LOCATION 154: PROGRAMMING THE CURRENT YEAR - TENS DIGIT

Location 154 contains the current year - tens digit. If the current year is 1990, this location should contain a 9, which is the tens digit of the current year.

LOCATION 155: PROGRAMMING THE CURRENT YEAR - ONES DIGIT

Location 155 contains the current year - ones digit. If the current year is 1990, this location should contain a "0", which is the ones digit of the current year. If the current year is 1991, this location should contain a "1", which is the ones digit of the current year.

LOCATION 156: PROGRAMMING THE CURRENT DAY OF THE MONTH - TENS DIGIT

Location 156 contains the current day of the month - tens digit. If the current day of the month is the 5th (05), this location should contain a "0", which is the current day of the month - tens digit. If the current day of the month is the 26th, this location should contain a "2".

LOCATION 157: PROGRAMMING THE CURRENT DAY OF THE MONTH - ONES DIGIT

Location 157 contains the current day of the month - ones digit. If the current day of the month is the 5th (05), this location should contain a "5", which is the current day of the month - ones digit. If the current day of the month is the 26th, this location should contain a "6".

LOCATION 158: PROGRAMMING THE CURRENT HOUR - TENS DIGIT

Location 158 contains the current hour - tens digit. The time is entered in 24 hour time. If the current time is 5:25 PM, the 24 hour time is 17:25, so this location should contain a "1", which is the current hour - tens digit. If the current time is 9:36 AM, the 24 hour time is 09:36, so this location should contain a "0".

LOCATION 159: PROGRAMMING THE CURRENT HOUR - ONES DIGIT

Location 159 contains the current hour - ones digit. The time is entered in 24 hour time. If the current time is 5:25 PM, the 24 hour time is 17:25, so this location should contain a "7", which is the current hour - ones digit. If the current time is 9:36 AM, the 24 hour time is 09:36, and this location should contain a "9".

LOCATION 160: PROGRAMMING THE CURRENT MINUTES - TENS DIGIT

Location 160 contains the current minutes - tens digit. The time is entered in 24 hour time. If the current time is 5:25 PM, the 24 hour time is 17:25, so location 160 should contain a "2", which is the current minutes - tens digit. If the current time is 9:36 AM, the 24 hour time is 09:36, and this location should contain a "3".

LOCATION 161: PROGRAMMING THE CURRENT MINUTES - ONES DIGIT

Location 161 contains the current minutes - ones digit. The time is entered in 24 hour time. If the current time is 5:25 PM, the 24 hour time is 17:25, so this location should contain a "5", which is the current minutes - ones digit. If the current time is 9:36 AM, the 24 hour time is 09:36, and this location should contain a "6".

LOCATION 162: PROGRAMMING THE HOUR FOR AUTOTEST - TENS DIGIT

Location 162 contains the tens digit of the hour that the autotest report is initiated. The time is entered in 24 hour time. If the desired autotest time is 5:25 PM, the 24 hour time is 17:25, so this location should contain a "1", which is the tens digit of the desired hour for autotest. If the desired autotest time is 9:36 AM, the 24 hour time is 09:36, and this location should contain a "0".

LOCATION 163: PROGRAMMING THE HOUR FOR AUTOTEST - ONES DIGIT

Location 163 contains the ones digit of the hour that the autotest report is desired. The time is entered in 24 hour time. If the desired autotest time is 5:25 PM, the 24 hour time is 17:25, so this location should contain a "7", which is the ones digit of the hour for autotest. If the desired autotest time is 9:36 AM, the 24 hour time is 09:36, and this location should contain a "9".

LOCATION 164: PROGRAMMING THE MINUTES FOR AUTOTEST - TENS DIGIT

Location 164 contains the tens digit, of the minutes after the hour that the autotest is desired. The time is entered in 24 hour time. If the desired autotest time is 5:25 PM, the 24 hour time is 17:25, so this location should contain a "2", which is the tens digit of the minutes for autotest time. If the desired autotest time is 9:36 AM, the 24 hour time is 09:36, and this location should contain a "3".

LOCATION 165: PROGRAMMING THE MINUTES FOR AUTOTEST - ONES DIGIT

Location 165 contains the ones digit, of the minutes after the hour that the autotest is desired. The time is entered in 24 hour time. If the desired autotest time is 5:25 PM, the 24 hour time is 17:25, so this location should contain a "5", which is the ones digit of the minutes for autotest time. If the desired autotest time is 9:36 AM, the 24 hour time is 09:36, and this location should contain a "6".

LOCATION 166: PROGRAMMING THE AUTOTEST TIME REPORTING INTERVAL

Location 166 contains the number of days between automatic test reports. If a report is desired every 7 days, this location should contain a "7". Valid entries are "1" to "15" days.

LOCATION 167: PROGRAMMING FOR ROTATING MAINTENANCE CODES

The Ranger 8600 has the ability to automatically generate a different MAINTENANCE arm/disarm code daily. This code is produced using the current date programmed in locations 153-157, and the 4 digit complex or "seed code", programmed in locations 168-171. This code can then be generated by using the CG-800 "Code Generating Software" which is designed to operate on a DOS based personal computer. If this location contains a "1", the maintenance code is enabled and the code will change daily. If this location contains a "3", the code will change on the first day of each month. If location 167 contains a "0", this feature is disabled, and the user #7 arm/disarm code will be the code programmed in locations 024-027. NOTE: ACTIVATING THE MAINTENANCE CODE WILL AUTOMATICALLY DISABLE THE DURESS CODE, REGARDLESS OF WHAT IS PROGRAMMED IN LOCATIONS 086-087.

LOCATION 168-171: PROGRAMMING THE SEED CODE FOR ROTATING MAINTENANCE CODES

Locations 168-171 contain the complex, or "seed code" required to generate rotating maintenance codes as described in the paragraph above. These locations allow a unique set of codes for different buildings or complexes. NOTE: ACTIVATING THE MAINTENANCE CODE WILL AUTOMATICALLY DISABLE THE DURESS CODE, REGARDLESS OF WHAT IS PROGRAMMED IN LOCATIONS 086-087.

LOCATION 172: PROGRAMMING USER 7 OR MAINTENANCE CODE OPENING COMMUNICATOR CODE

The Ranger 8600 has the ability to give an opening report each time user number 7 disarms the control. The desired opening code should be programmed in this location. This feature can be used in conjunction with the rotating maintenance code to give an opening report each time the maintenance code is used to disarm. When using an extended format, the extended code will always be a 7.

LOCATION 173: PROGRAMMING USER 7 OR MAINTENANCE CODE CLOSING COMMUNICATOR CODE

The Ranger 8600 has the ability to give a closing report each time user number 7 arms the control. The desired closing code should be programmed in this location. This feature can be used in conjunction with the rotating maintenance code to give a closing report each time the maintenance code is used to arm. When using an extended format, the extended code will always be a 7. CAUTION! If a "Quick Arm" code has been selected, and the first digit of the rotating maintenance code is the same digit as the "Quick Arm" code, the maintenance closing code will not be reported.

LOCATION 174: PROGRAMMING ZONES 3 THROUGH 6 FOR NORMALLY CLOSED OPERATION ONLY

Location 174 is used to program zones 3,4,5,& 6 for normally closed operation only, eliminating the need for the end of line resistors on that zone. When a zone is programmed for normally closed operation only, a short will not change the loop condition, and an open on that zone will produce a faulted condition. This feature will be ignored by any Priority zone. To program a zone for normally closed only, use the following chart and program the appropriate number in this location.

ZONES PROGRAMMED FOR NC OPERATION	DATA FOR LOCATION 174
6	"1"
5	"2"
5 & 6	"3"
4	"4"
4 & 6	"5"
4 & 5	"6"
4,5, & 6	"7"
3	"8"
3 & 6	"9"
3 & 5	A ="10"
3,5, & 6	B ="11"
3 & 4	C ="12"
3,4, & 6	D ="13"
3,4, & 5	E ="14"
3,4,5, & 6	F ="15"

LOCATION 175: PROGRAMMING ZONES 1 AND/OR 2 FOR NORMALLY CLOSED OPERATION ONLY

Location 175 is used to program zones 1 and/or 2 for normally closed operation only, eliminating the need for the end of line resistors on these zones. When a zone is programmed for normally closed operation, a short on that zone will not change the loop condition, and an open on that zone will produce a faulted condition. This feature will be ignored by any Priority zone. To program a zone for normally closed only, use the following chart and program the appropriate number in this location.

ZONES PROGRAMMED FOR NC OPERATION	DATA FOR LOCATION 175
2	"1"
1	"2"
2 & 1	"3"

LOCATION 176: SPLIT REPORTING - PROGRAMMING TAMPER, DOWNLOAD COMPLETE, AND AUTOTEST TO REPORT TO THE SECONDARY PHONE NUMBER

The 8600 is capable sending certain reports to the secondary telephone number. This feature known as split reporting can be used to send alarm reports to one number and supervisory reports to another number. When using split reporting with the 8600, the primary telephone number always takes priority over the secondary telephone number. The 8600 always sends zone and alarm reports to the primary telephone number. There are 8 reports that can be programmed to report to the second telephone number. Location 176 is used to force up to four of these individual reports to the second telephone number. To program tamper, download complete, or autotest to report to the secondary telephone number, use the following chart and program the appropriate number in location 176.

REPORTS TO SEND TO SECONDARY NUMBER	DATA FOR LOCATION 176
AUTOTEST	"2"
DOWNLOAD COMPLETE	"4"
DOWNLOAD COMPLETE; AUTOTEST	"6"
TAMPER	"8"
TAMPER; AUTOTEST	A ="10"
TAMPER; DOWNLOAD COMPLETE	C ="12"
TAMPER; DOWNLOAD COMPLETE; AUTOTEST	E ="14"

LOCATION 177: SPLIT REPORTING - PROGRAMMING AC POWER FAIL, LOW BATTERY, OPEN/CLOSE, AND MAINTENANCE OPEN/CLOSE TO REPORT TO THE SECONDARY PHONE NUMBER

The 8600 is capable sending certain reports to the secondary telephone number. This feature known as split reporting can be used to send alarm reports to one number, and supervisory reports to another number. When using split reporting with the 8600, the primary telephone number always takes priority over the secondary telephone number. The 8600 always sends zone and alarm reports to the primary telephone number. There are 8 reports that can be programmed to report to the second telephone number. Location 177 is used to force up to four of these individual reports to the second telephone number. To program AC power fail, low battery, open/close, or maintenance code open/close to report to the secondary telephone number, use the following chart and program the appropriate number in this location.

REPORTS TO SEND TO SECONDARY NUMBER	DATA FOR LOCATION 177
MAINT CODE OPEN/CLOSE	"1"
OPEN/CLOSE	"2"
OPEN/CLOSE; MAINT CODE OPEN/CLOSE	"3"
LOW BATTERY	"4"
LOW BATTERY; MAINT CODE OPEN/CLOSE	"5"
LOW BATTERY; OPEN/CLOSE	"6"
LOW BATTERY; OPEN/CLOSE; MAINT CODE OPEN/CLOSE	"7"
AC FAIL	"8"
AC FAIL; MAINT CODE OPEN/CLOSE	"9"
AC FAIL; OPEN/CLOSE	A ="10"
AC FAIL; OPEN/CLOSE; MAINT CODE OPEN/CLOSE	B ="11"
AC FAIL; LOW BATTERY	C ="12"
AC FAIL; LOW BATTERY; MAINT CODE OPEN/CLOSE	D ="13"
AC FAIL; LOW BATTERY; OPEN/CLOSE	E ="14"
AC FAIL; LOW BATTERY; OPEN/CLOSE; MAINT CODE OPEN/CLOSE	F ="15"

LOCATION 178: PROGRAMMING THE SECONDARY ENTRY DELAY (ZONE TYPE 9)

Location 178 contains the number of 10 second increments in the entry delay, when an entry delay is initiated by a zone type 9. The entry delay can be programmed in 10 second increments from 10 to 150 seconds ("1" = 10 seconds through "15" = 150 seconds). For example, programming a "2" in this location will produce an entry delay of 20 seconds. (Note: A "0" entry is treated as zero (0) seconds). Programming a "6" in this location will produce an entry delay of 60 seconds.

LOCATION 179: PROGRAMMING THE SECONDARY EXIT DELAY (ZONE TYPE 9)

Location 179 contains the number of 10 second increments after arming, before trips will be recognized on a zone type 9. The exit delay can be programmed in 10 second increments from 10 to 150 seconds ("1" = 10 seconds through "15" = 150 seconds). For example, programming a "2" in this location will produce an exit delay of 20 seconds. (Note: A "0" entry is treated as zero (0) seconds). Programming a "6" in this location will produce an exit delay of 60 seconds. If the exit delay time in this location is less than, or equal to that in location 076, zone type "9" will be delayed the amount of time in location 076.

LOCATION 180: PROGRAMMING THE LOOP RESPONSE TIME

Location 180 is used to program the loop response time for all zones. The response time is equal to 20 milliseconds times the number programmed in this location ("1" = 20 milliseconds and "5" = 100 milliseconds). If this location contains a "0", the loop response time will be 500 milliseconds.

LOCATIONS 181-185: DO NOT PROGRAM THESE LOCATIONS (each should be "0")

THE FOLLOWING LOCATIONS ARE ACCESSIBLE ONLY THROUGH DOWNLOADING

LOCATIONS 186-193: CONTROL PANEL ACCESS CODE

Locations 186-193 contain the eight digit access code the 8600 must receive from the downloading software before the panel will permit downloading to occur. The factory default code is listed in the instructions provided with the CADDX download software package.

LOCATIONS 194-209: CALL BACK TELEPHONE NUMBER

The presence of a phone number in locations 194-209 will cause the control panel to dial back this number after a successful panel access code has been entered. If a telephone number is present, the control panel will hang up for approximately 36 seconds (insuring that the calling party has disconnected), then it will call back. Any zero (0) within the telephone number must be programmed as an "A". If tone dialing is desired, program an "F" in the location where tone dialing should begin. If the entire number should be tone dialing, program an "F" in location 194. Four second delays can be obtained anywhere in the sequence by programming a "D" in the appropriate delay location. WARNING: CALLBACK PHONE NUMBER SHOULD ALWAYS BE REVIEWED FOR ACCURACY BEFORE DISCONNECTING.

LOCATION 210: ANSWERING MACHINE DEFEAT

Location 210 contains the answering machine defeat enable. To defeat an answering machine, two telephone calls must be made to the premises. On the first call, let the phone ring the same number of times (or less) as the number programmed in location 210 (maximum 3). The control panel will detect these rings and start a 45 second timer. If a call comes in during that 45 second time frame, the control panel will answer on the first ring. To disable this feature, program a "0" in this location.

LOCATION 211: LOCAL PROGRAMMING LOCKOUT

Location 211 is used to disable local programming lockout. If a "5" is programmed in this location, all local programming is locked out. If an "A" is programmed in this location, all programming functions related to the digital communicator will be locked out. Any other number in location 211 will allow all local programming.

LOCATION 212: CONTROL PANEL SHUTDOWN

Location 212 is used to shut down the control panel. Programming an "A" in this location will completely shutdown the control panel. The keypad will appear "dead", and the siren and communicator will not operate. WARNING: EXTREME CARE SHOULD BE TAKEN NOT TO INADVERTENTLY PROGRAM THIS LOCATION.

GENERAL OPERATING INSTRUCTIONS

Arming and Disarming the Ranger 8600

To turn the security system on, close all protected doors and windows. The green "Ready" light will be on. Input a valid code to change the armed status. If the armed status is changed when a PRIORITY zone type has been in alarm or trouble, or the A.C. LED is off, the keypad sounder will start beeping. Entering the code again will silence the keypad sounder and not change armed status (pressing the RESET [#] key will reset the LEDES for PRIORITY zones if the short has cleared). The following conditions will prevent the armed status from changing when a code is entered:

- 1. The Ready light is out and the system is currently disarmed (the keypad sounder will beep 3 times if green Ready LED is not illuminated).
- 2. The siren is currently on for something other than a control zone (in this case silence the siren).
- 3. The keypad sounder is currently beeping for Priority zone type Trouble or a Day zone (in this case silence the keypad sounder).
- 4. A zone is bypassed and "No Arming With Zone Bypassed" mode has been selected in the location 138.

Bypassing Zones

To bypass any of the zones 1-6, disarm the control and press [*],zone number(s) to bypass, and [*]. If the control is in the disarmed state, the bypass condition of the zones will toggle. Priority zones cannot be bypassed.

Entering and Changing the Master Code (User Code #1)

When the Ranger 8600 is first powered-up, the master code standard default is [1][2][3][4]. To change the master code from the keypad in the run (standard) mode from [1][2][3][4] to [5][6][7][8], the sequence is as follows: Press [*][1][#] which enters programming for user code #1. Now press the current master code of [1][2][3][4], followed by [*][1][#] verifying that user code #1 is being changed. Now, enter the new code of [5][6][7][8], followed by [*][1][#] to exit programming of codes. So, the entire procedure would consist of pressing 17 keys as follows:

[*][1][#] - [1][2][3][4] - [*][1][#] - [5][6][7][8] - [*][1][#]
(MASTER CODE) (NEW CODE)

(NOTE: IF THE MASTER CODE IS CHANGED, ALL AUXILIARY CODES ARE INVALIDATED !)

Entering and Changing an Auxiliary Code

When the Ranger 8600 is first powered-up the auxiliary codes are disabled. In order to program auxiliary codes you must know the master code (user code #1). Each auxiliary code has its own unique number from 2 through 7 and must be referred to by its number. The auxiliary code is programmed much like changing the master code. For example: to program auxiliary code #2 the sequence would be as follows:

[*][2][#] - [1][2][3][4] - [*][2][#] - [][][][] - [*][2][#]
 (MASTER CODE) (NEW CODE)

Codes 3 through 7 would be entered by using the above sequence and replacing [2] with the appropriate number 3-7.

Removing Auxiliary Codes

To remove an auxiliary code, simply program it to be the master code. For example, to remove user code #2, the sequence would be as follows:

[*][2][#] - [1][2][3][4] - [*][2][#] - [1][2][3][4] - [*][2][#]

User code #2 has now been eliminated.

Quick Arm Feature

This code cannot be entered in the run mode. It is only accessible in the program mode.

Note: If an attempt is made to change any of the codes from the keypad, and a invalid master code is entered, or a [*] or [#] is made part of a code, the keypad sounder will beep 3 times and the keypad will return to the normal state. If the master code is changed, all auxiliary codes will be invalidated.

Arming and Disarming With Automatic Bypass/Instant Arming

If "Automatic Bypass/Instant Arming" is enabled, there are three ways to arm the Ranger 8600.

1.) Input an arm/disarm code and leave the building through an entry/exit door. There will be an exit delay for leaving. When returning through an entry/exit door or delayed zone, the keypad sounder will beep continuously to remind you to disarm the system promptly.

2.) Input an arm/disarm code and stay in the building. If no entry/exit zones are tripped during the exit delay, and location 131 contains a "1", the interior follower zones will automatically bypass, the entry/exit zones will become instant, and the "Instant" LED will become illuminated. With a "3" in location 131, the interior follower zones will bypass, but the entry/exit zones will not change. In either case, the entry delay zones will not be effected.

3.) Bypass all the interior zones, arm the system and stay in or leave the building. In both cases, the Entry/Exit zones will not become instant if all the interior zones were bypassed prior to arming.

Door Chime Annunciation

This feature is used as an annunciator feature when the Ranger 8600 is disarmed. When Door Chime Annunciation is activated, a fault on a delayed, instant, or entry/exit zone will produce a one second beep. To activate Door Chime Annunciation, enter the first digit of the master code and wait 5 seconds. The keypad will produce a one second sound (beep) to notify you of the activation of this feature. Follow the same procedure to deactivate the Door Chime Annunciation feature. This feature cannot be activated when the system is armed. If the "Quick Arm" digit is the same as the first digit of the Master code, Door Chime Annunciation will not function.

Smoke-Detector Reset

Pressing the RESET [#] key when a PRIORITY zone type has been in alarm or trouble will produce a 10 second power down of the resettable power output. When power is restored to the loop, the zone light(s) for PRIORITY zones will extinguish if the Priority loop(s) have returned to a normal state. The condition of the Priority loop is ignored during reset. The Ranger 8600 can also be programmed to produce a 10 second power down of the resettable power output, without regard for the condition of the PRIORITY loops (only when the Ranger 8600 is disarmed). This feature can be used with other sensors when memory LED's are reset by removal of power. If the PRIORITY loop(s) have not reset, the keypad sounder will begin to beep at the end of the 10 second reset period.

Alarm History

Five seconds after pressing the [0] key, the keypad will announce "Freeze Frame" alarm history. The zone LED's will indicate which zone(s) caused the last alarm, regardless of the number of times the Ranger 8600 has been armed or disarmed since that alarm. It announces by blinking the zone LED(s) that caused the alarm, and lighting steady those that were bypassed when that alarm occurred. The annunciation will continue for 5 seconds. Alarm History is erased when the the Ranger 8600 is put into the program mode. A burglary zone that has been bypassed due to "Swinger Shutdown" will alternate between continuous and blinking.

Siren/Bell Test Feature

This feature is enabled by programming a "1" in location 142. When enabled, pressing the [1] and [7] keys simultaneously on the keypad, the siren or bell will sound without making a communication. Entering an arm/disarm code will silence the siren/bell.

Zone Recycling

All zones on the Ranger 8600 will reset independent of each other. When a zone has reset, it is then able to create another audible alarm. If the siren/bell has not recycled, a trip or a re-trip will extend the time for another recycle period.

KEYPAD OPERATION

The Ranger 8600 will accept up to four #8601 Control Keypads. The keypad is a four wire keypad that has a 12 key telephone type keypad, a sounder, and 10 LEDs.

The LEDs are used to indicate the following:

ARMED - (red) On when system is armed; off otherwise. Blinks on non-24 hour zones as alarm memory until a valid code is entered.

READY - (green) On when all burglary zones are secure; off otherwise.

INSTANT - (red) On when the entry/exit zones are instant; off otherwise.

AC ON - (red) On when AC power is on; off otherwise. This light will not go out in the LED extinguish mode unless A.C. power is lost.

ZONES 1-6 - (yellow) On when bypassed; blinking when faulted; off otherwise. When "Freeze Frame" alarm history is being shown, LED's will blink for prior alarm, and will be on continuous for bypass. If a particular zone has been programmed for Priority, the light will be on continuous for alarm, and blinking for trouble.

Keypad Sounder - The keypad sounder is built into the keypad and will sound for the following reasons:

- Beeps for all key presses.
- Sounds continuously during entry delay.
- Pulses when a Day zone trips, when Priority trouble occurs, or when the armed status changes and one of the zones has been in alarm or trouble is on, or if the A.C. LED is off.
- When pulsing, it can be silenced by entering a code. (armed status will not change)
- 3 Beeps for trying to arm when a faulted zone is not bypassed.
- Beeps 1 second for "Door Chime Annunciation" and activation of "Door Chime Annunciation".
- 3 Beeps when errors are made reprogramming codes.
- Beeps 1 second at the end of the exit delay.
- Beeps 3 times when all zones are bypassed or any zone is bypassed and the "No Arming With A Zone Bypassed" mode has been selected in location 138.
- Beeps 3 times when a error is made when bypassing a zone.
- Beeps 3 times to let the user know if the armed status did not change.
- Pulses continuously after reset attempt when loop has not restored.

LOCAL TELEPHONE COMPANY INTERFACE INFORMATION

TELEPHONE CONNECTION REQUIREMENTS

Except for telephone company provided ringers, all connections to the telephone network shall be made through standard plugs and standard telephone company provided jacks or equivalent in such a manner as to allow for immediate disconnection of the terminal equipment. Standard jacks shall be so arranged that if the plug connected thereto is withdrawn, no interference to the operation of the equipment at the customers premises which remains connected to the telephone network, shall occur by reason of such withdrawal.

INCIDENCE OF HARM

Should terminal equipment or protective circuitry cause harm to the telephone network, the telephone company shall, where practical, notify the customer that temporary discontinuance of service may be required; however, where prior notice is not practical, the telephone company may temporarily discontinue service if such action is deemed reasonable in the circumstances. In the case of such temporary discontinuance, the telephone company shall promptly notify the customer who will be given the opportunity to correct the situation. The customer also has the right to bring a complaint to the FCC if he feels the disconnection is not warranted.

CHANGES IN TELEPHONE COMPANY EQUIPMENT OR FACILITIES

The telephone company may make changes in its communications facilities, equipment, operations, or procedures where such action is reasonably required and proper in its business. Should any such change render the customers terminal equipment incompatible with the telephone company facilities, the customer shall be given adequate notice to make modifications to maintain uninterrupted service.

GENERAL

The FCC prohibits customer provided terminal equipment be connected to party lines.

IMPORTANCE OF THE RINGER EQUIVALENCE NUMBER

The Ringer Equivalence Number of this device is 0.2 B. This number is a representation of the electrical load that it applies to your telephone line.

MALFUNCTION OF THE EQUIPMENT

In the event that the device should fail to operate properly, the customer shall disconnect the equipment from the telephone line to determine if it is the customers equipment that is not functioning properly. If the problem is with the device the customer shall discontinue use until it is repaired.

EQUIPMENT INFORMATION

MANUFACTURER OF CONNECTING EQUIPMENT: CADDX-CADDI CONTROLS INC., FCC REGISTRATION NUMBER: GCQ4DC-17266-AL-E, RINGER EQUIVALENCE: 0.2 B

SPECIFICATIONS

OPERATING POWER	16.5 VAC 25 VA Transformer
AUXILIARY POWER	12 VDC Regulated 500 mA
LOOP RESISTANCE	300 Ohms Maximum
BUILT-IN SIREN DRIVER	2-tone (Steady and Yelp)
ALARM CURRENT AVAILABLE (if above driver is not used)	1 Amp
LOOP RESPONSE	Selectable to 500ms
OPERATING TEMPERATURE	32° to 120° F
KEYPAD DIMENSIONS	5.50" Wide- 4.25" High 0.850" Deep
METAL ENCLOSURE DIMENSION	11.25" Wide 11.25" High 3.50" Deep
SHIPPING WEIGHT	9 lbs.

WARRANTY STATEMENT

CADDX-CADDI CONTROLS, INC. GUARANTEES THIS PRODUCT AGAINST DEFECTIVE PARTS AND WORKMANSHIP FOR TWENTY-FOUR (24) MONTHS FROM DATE OF MANUFACTURING.

IF ANY DEFECT APPEARS DURING THE WARRANTY PERIOD RETURN IT TO CADDX, POSTAGE PREPAID. THE UNIT WILL BE REPAIRED AND RETURNED.

CADDX ASSUMES NO LIABILITY FOR CONSEQUENTIAL OR INDIRECT DAMAGE AND ACCEPTS NO RESPONSIBILITY FOR REPAIRING DAMAGE TO THE PRODUCT CAUSED BY MISUSE, CARELESS HANDLING, OR WHERE REPAIRS HAVE BEEN MADE BY OTHERS.

NO OTHER GUARANTEE, WRITTEN OR VERBAL, IS AUTHORIZED BY OR ON BEHALF OF CADDX-CADDI CONTROLS, INC., GLADEWATER, TEXAS.

**CADDX-CADDI CONTROLS, INC
1420 NORTH MAIN STREET
GLADEWATER, TEXAS 75647
IN TEXAS 800-727-2339
NAT. TOLL FREE 800-652-2339**