

PowerSeries

PC1616/PC1832/PC1864 version 4.2 NA

Installation Guide

DSC®
PowerSeries™
SECURITY SYSTEM



WARNING: This manual contains information on limitations regarding product use and function and information on the limitations as to liability the manufacturer. The entire manual should be carefully read.

Table of Contents

Section	Description	Page
1	Installation & Wiring	1
1.1	Keybus Wiring	2
1.2	Zone Wiring.....	2
1.3	Zone Expanders.....	2
1.4	Bell Wiring	2
1.5	AUX Power Wiring.....	4
1.6	PGM Wiring.....	4
1.7	Telephone Line Wiring.....	4
1.8	Ground	4
1.9	Battery.....	4
1.10	AC Wiring	4
2	User Commands	5
2.1	Away Arming	5
2.2	Stay Arming.....	5
2.3	Disarming	5
2.4	[*] Commands.....	5
2.5	Function keys	7
3	Programming	8
3.1	Template Programming	8
3.2	DLS Programming.....	8
3.2.1	Local Programming.....	8
3.2.2	Remote Programming (via telephone line).....	8
3.3	Advanced Keypad Programming.....	8
3.3.1	Programming Toggle Options.....	9
3.3.2	Programming Decimal & Hexadecimal Data.....	9
3.3.3	How to Exit Programming.....	9
3.3.4	Viewing Programming	9
4	Programming Descriptions	10
5	Programming Worksheets	27
6	For the Record	52
7	Zone Programming Summary	53
App A	Reporting Code Formats (Contact ID, SIA)	APP A
App B	UL Listing Requirements	APP B
App C	SIA False Alarm Reduction Quick Reference Chart	APP C
App D	Troubleshooting Guide	APP D
App E	Template Programming	APP E

Section 1: Installation & Wiring

This Installation Guide provides the basic installation, wiring and programming information required to program the PowerSeries PC1616, PC1832 and PC1864 control panels. This guide shall be used in conjunction with the *PowerSeries PC1616/1832/1864 Reference Manual* which can be obtained from your local dealer or downloaded from the DSC web site at www.dsc.com.

 All necessary information required to meet UL Listing requirements is included in this document.

Technical Summary

	FEATURES	PC1616	PC1832	PC1864
OUT OF THE BOX Qty 1 <input type="checkbox"/> Cabinet Qty 1 <input type="checkbox"/> PC Module Qty 1 <input type="checkbox"/> Installation guide Qty 1 <input type="checkbox"/> User manual Qty 2 <input type="checkbox"/> Cabinet Label Qty 1 <input type="checkbox"/> Cabinet Door Plug Qty 4 <input type="checkbox"/> Standoffs Qty 16 <input type="checkbox"/> 5.6KΩ Resistors Qty 1 <input type="checkbox"/> 2.2KΩ Resistor Qty 1 <input type="checkbox"/> 1.0KΩ Resistor Qty 1 <input type="checkbox"/> Grounding Kit	On-board Zones	6	8	8
	Hardwired Zones	16 (1xPC5108)	32(3xPC5108)	64 (7xPC5108)
	Wireless Zones	32	32	32
	Keypad Zone Support	✓	✓	✓
	On-board PGM Outputs	PGM 1 - 50mA PGM 2 - 300mA	PGM 1 - 50mA PGM 2 - 300mA	PGM 1, 3, 4 - 50mA PGM 2 - 300mA
	PGM Expansion	8x50mA (PC5208) 4x500 mA (PC5204)	8x50mA (PC5208) 4x500 mA (PC5204)	8x50mA (PC5208) 4x500 mA (PC5204)
	Keypads	8	8	8
	Partitions	2	4	8
	User Codes	47 + Master Code	71 + Master Code	94 + Master Code
	Event Buffer	500 Events	500 Events	500 Events
Transformer Required	16.5VAC/40VA	16.5VAC/40VA	16.5VAC/40VA	
Battery Required	4Ah / 7Ah/14Ahr	4Ah / 7Ah/14Ahr	4Ah / 7Ah/14Ahr	
Bell Output	12V/700 mA (cont)	12V/700 mA (cont)	12V/700 mA (cont)	

SPECIFICATIONS
Temp Range 0°C-49°C (32°F-120°F)
Humidity (Max) 93%R.H.
Power Supply 16.5VAC/40VA @60Hz
Current Draw (Panel)..... 110mA (nom.)
Aux+ Output 11.1-12.6VDC/700mA
Bell Output..... 11.1-12.6VDC/700mA

COMPATIBLE DEVICES

Keypads (Backward compatible with all PowerSeries keypads)	Modules
PK55XX Keypad..... 125mA (max.)	T-Link TL150*TL-250/TL300 275/350mA
RFK55XX Keypad 135mA (max.)	PC5100 2-wire Interface 40mA plus devices to 170mA max.
LCD5511 Fixed Message LCD Keypad 85mA (max.)	PC5132-433 Wireless Receiver 125mA
LED5511Z 8-zone LED Keypad 100mA (max.)	RF5108-433 Wireless Receiver 125mA
Cabinets	
PC5003C222x298x78mm (11.3x11.7x3.0in)	PC5108 Zone Expander 30mA
PC500C (residential burg only)213x235x78mm (8.4x9.25x3.0in)	PC5200 Power Supply 20mA
PC4050CAR (UL commercial burg)305x 376x124mm (12.0x14.8x4.9in)	PC5204 Power Supply with 4 Programmable Outputs 30mA
CMC-1 (UL commercial burg)287x297x76mm (11.3x11.7x3.0in)	PC5208 Low Current Programmable Output Module 50mA
Suttle, SAE 14355.6 x 362x 95mm (14x14.25x 3.75in)	PC5400 Printer 65mA
Suttle, SAE 21533.4 x 362x 95mm (21x14.25x 3.75in)	PC5401 Bi-Directional RS232 Module (Not UL Listed) 65mA
Suttle, SAE 28711.2 x 362x 95mm (28x14.25x 3.75in)	Escort5580 Telephone Interface Module 130mA
Suttle, SAE 421066.8 x 362x 95mm (42x14.25x 3.75in)	
<i>Refer to the Reference Manual for alternate control cabinets</i>	
<i>*The T-Link TL-150 is not UL/ULC listed</i>	
<i>Refer to the Reference Manual for additional devices.</i>	

Classified in Accordance with ANSI/SIA CP-01-2000 (SIA-FAR)

Installation

Begin the installation by mounting additional modules in the cabinet using the standoffs provided, then mount the cabinet in a dry protected area with access to unswitched AC power.

Install Hardware in the sequence indicated in the following pages. Do **NOT** apply power until installation is complete.

 All wiring entry points are designated by arrows. All circuits are classified UL power limited except for the battery leads. Minimum 1/4" (6.4mm) separation must be maintained at all points between power limited and non-power limited wiring and connections.

1.1 Keybus Wiring

The 4-wire KEYBUS (red, black, yellow and green) is the communication connection between the control panel and all modules. The 4 KEYBUS terminals of all modules must be connected to the 4 KEYBUS terminals of the main control panel.

The following rules must be followed when wiring the Keybus:

- Minimum 22 AWG wire, maximum 18 AWG (2-wire twisted preferred)
- Do **NOT** use shielded wire
- Modules can be home run, connected in series or can be T-tapped provided that the maximum wire distance from the control panel to any module does not exceed 1,000 feet (305m)
- No more than 3,000 feet (915m) of wire can be used in total

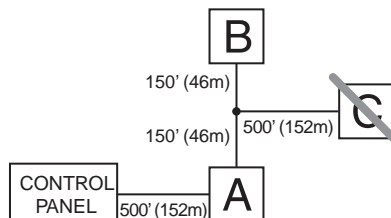

1.2 Zone Wiring

Zones can be wired for Normally Open, Normally Closed Contacts with Single-end-of-line (SEOL) resistors or Double End-of-Line (DEOL) resistors. Observe the following guidelines

- For **UL** Listed Installations use SEOL or DEOL only.
- Minimum 22 AWG wire, maximum 18 AWG
- Do **NOT** use shielded wire
- Wire run resistance shall not exceed 100Ω. Refer to the chart below.

Burglary Zone Wiring Chart	
Wire Gauge	Maximum wire Length to End-of-line Resistor (feet/meters)
22	3000 / 914
20	4900 / 1493
19	6200 / 1889
18	7800 / 2377
Figures are based on maximum wiring resistance of 100Ω	

- Section [001]-[004] Selects Zone Definition
- Section [013] Opt [1] Selects Normally Closed or EOL resistors
- Section [013] Opt [2] Selects Single EOL or Double EOL resistors.
- Section [101]-[108] Opt [14], [15], [16] Selects Normally Closed Single EOL or Double EOL for on-board zones (PC1864, PC1832, Zone 1-8; PC1616, Zone 1-6),

Zone Status - Loop Resistance/Loop Status

- **Fault** - 0Ω (shorted wire/loop)
- **Secure** - 5600Ω (contact closed)

Normally Closed Loops - Do NOT use for UL Installations

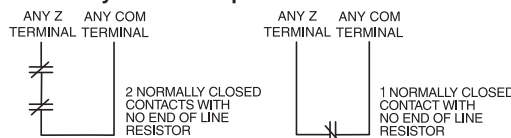

Single End-of-Line Resistor Wiring

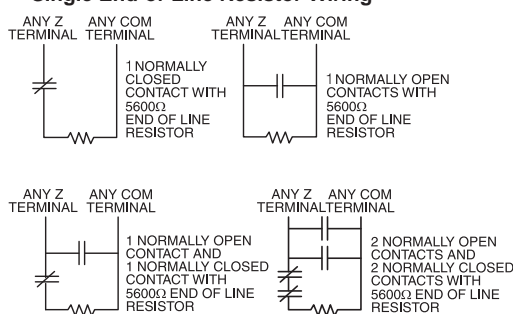

Double End-of-Line Resistor Wiring

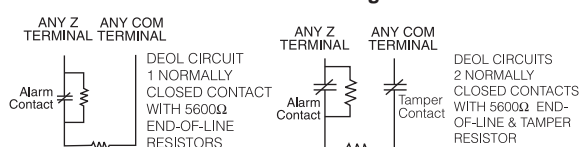

- **Tamper** - infinite (broken wire, open)
- **Violated** - 11,200Ω (contact open)

1.3 Zone Expanders

Zone expanders add zones in groups of eight to the Alarm system. Module jumpers J1, J2, J3 are required to assign zones to these modules.

Jumper settings for PC5108v2 are shown here.

- PC5108v1.0 supports first 32 zones only.
- PC5700 enrolls as two modules
- Do NOT use PC5108v1 & v2 on the same panel.0

Module

Jumpers

J1	J2	J3
ON	ON	ON
OFF	ON	ON
ON	OFF	ON
OFF	OFF	ON
ON	ON	OFF
OFF	ON	OFF
ON	OFF	OFF
OFF	OFF	OFF

Zones

Assigned

Zones Disabled
Zones 09-16
Zones 17-24
Zones 25-32
Zones 33-40
Zones 41-48
Zones 49-56
Zones 57-64

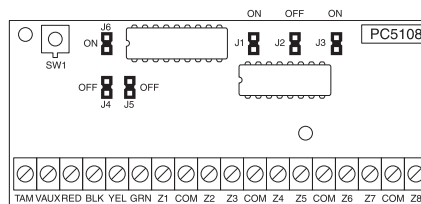

Refer to the associated installation sheet for Jumper locations for the PC5108v1, or PC5700

1.4 Bell Wiring

These terminals supply 700mA of current at 12VDC for commercial installations and 11.1-12.6 VDC for residential installations (e.g.DSC SD-15 WULF). To comply with NFPA 72 Temporal Three Pattern requirements: Program **Section [013] Opt [8] ON**.

NOTE: Steady, Pulsed alarms are also supported.

The Bell output is supervised and power limited by 2A PTC. If unused, connect a 1000Ω resistor across Bell+ and Bell- to prevent the panel from displaying a trouble. See [*][2].

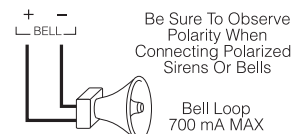

PC1616/1832/1864 Wiring Diagram

1. Insert Stand off into cabinet mounting hole in the desired location. Snap-in-place.
2. Position circuit board mounting holes over standoffs. Press firmly on board to snap-in-place.

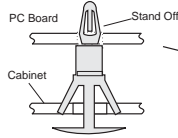

Primary: 120VAC/60Hz.
Secondary: 16.5VAC 40VA
DSCPTD 1640U
Class II Transformer

NOTE: Do not connect transformer to receptacle controlled by a switch

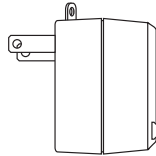

230 VAC/50 Hz International

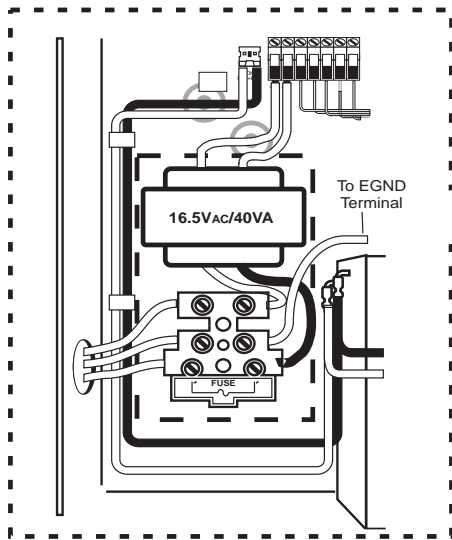

North America Only

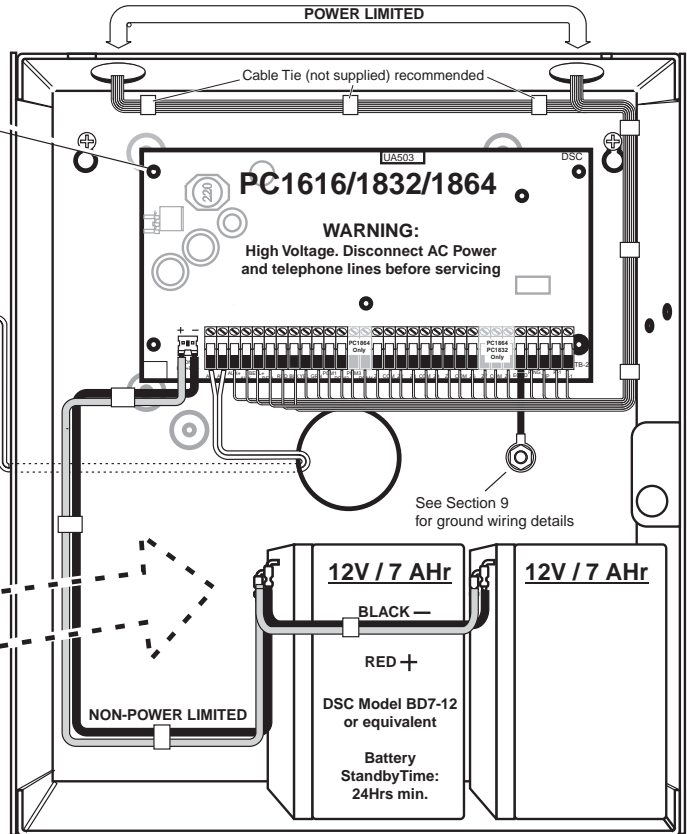

WARNING: Incorrect connections may result in PTC failure or improper operation. Inspect wiring and ensure connections are correct before applying power.

Incorrect connection of batteries may result in battery rupture or Fire Hazard. Do NOT allow metal objects to connect the Positive and Negative Terminals. Ensure that batteries are connected with correct polarity [Red to (+), Black to (-)]. Failure to comply with this may result in battery rupture and/or Fire Hazard. All circuits are classified for UL Installations as Power Limited/Class II Power Limited except for battery leads which are not power limited.

Do NOT route any wiring over circuit boards. Maintain at least 1" (25.4mm) separation. A minimum of 1/4" (6.4mm) separation must be maintained at all points between power limited wiring and all other non-power limited wiring.

IMPORTANT:

- This equipment, Alarm Controller PC1616/1832/1864 shall be installed and used within an environment that provides the pollution degree max 2 and overvoltages category II NON-HAZARDOUS LOCATIONS, indoor only. The equipment is FIXED and PERMANENTLY connected and is designed to be installed by service persons only; [service person is defined as a person having the appropriate technical training and experience necessary to be aware of hazards to which that person may be exposed in performing a task and of measures to minimize the risks to that person or other persons.]
- The connection to the mains supply must be made as per the local authorities rules and regulations. An appropriate disconnect device must be provided as part of the building installation. Where it is not possible to rely on identification of the neutral in the AC Mains supply the disconnecting device must disconnect both poles simultaneously (line and neutral). The device shall disconnect the supply during servicing.
- The equipment enclosure must be secured to the building structure before operation.
- Internal wiring must be routed in a manner that prevents:
 - Excessive strain on wire and on terminal connections;
 - Loosening of terminal; connections;
 - Damage of conductor insulation
- Disposal of the used batteries shall be made according to the waste recovery and recycling regulations applicable to the intended market.
- Before servicing, DISCONNECT the telephone connection.

WARNING:
High Voltage. Disconnect AC Power and telephone lines before servicing

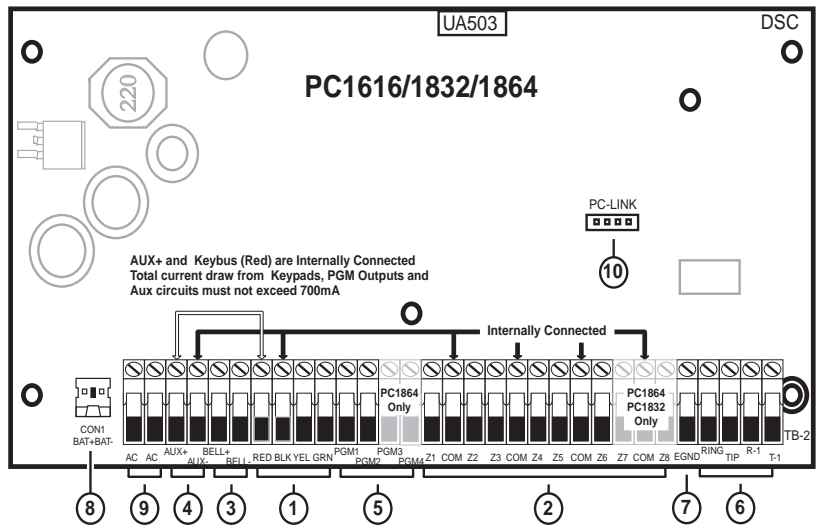

See corresponding Section NumberText for wiring details.

1.5 AUX Power Wiring

The control panel can provide a maximum of 700mA of current for modules, powered detectors, relays, LED's etc. If the total current required exceeds 700mA an additional power supply is required (e.g.,PC5200, PC5204). See list below.

Min/max operating voltages for devices, sensors and modules is 9.5Vdc - 14Vdc

Refer to the list of **Compatible Devices** on page 1 and/or the *Reference Manual* for the current draw of individual devices

1.6 PGM Wiring

PGMs switch to ground when activated by control panel. Connect the positive side of the device to be activated to the AUX+ Terminal. Connect the negative terminal to the PGM. current output is as follows

- PGM 1, 3, 4..... 50mA
- PGM 2..... 300mA

2-wire Smoke Detectors Initiating Circuit

- Style B (Class B), Supervised, Power Limited
- **UL** Compatibility Identifier..... PC18-1
- DC Output Voltage..... 9.8-13.8 VDC
- Detector Load 2mA (MAX)
- Single-end-of-line (SEOL) Resistor 2200Ω
- Loop Resistance 24Ω (MAX)
- Standby Impedance..... 1020Ω (NOM)
- Alarm Impedance..... 570Ω (MAX)
- Alarm Current..... 89mA (MAX)

UL Compatibility ID For FSA-210B Series is: FS200

NOTE: For ULC Listed installations use FSA-210A and FSA-410A series

Compatible 2-wire Smoke Detector
DSC FSA-210B Series

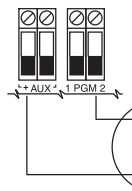

NOTE: Refer to Installation Manual and Smoke Detector Instruction Sheet when positioning detectors.

- FSA-210B
- FSA-210BT
- FSA-210BS
- FSA-210BST
- FSA-210BLST
- FSA-210BR
- FSA-210BRT
- FSA-210BR
- FSA-210BRST
- FSA-210BRST
- FSA-210BLRST

NOTE: Do NOT combine models from different Manufacturers On the same circuit. Operation may be impaired.

For currents levels greater than 300mA a relay is required. PGM2 can also be used for 2-wire smoke detectors.

NOTE: Use SEOL resistors on Fire Zones **ONLY**.

PGM 1, LED output with current limiting resistor and Optional Relay driver output

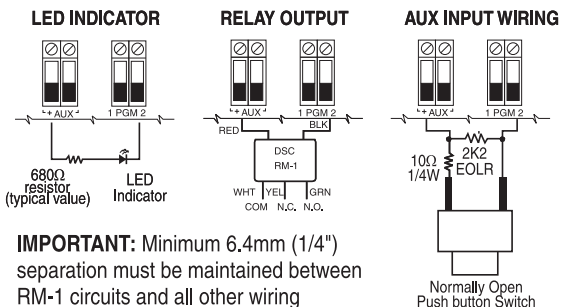

IMPORTANT: Minimum 6.4mm (1/4") separation must be maintained between RM-1 circuits and all other wiring

4-wire Smoke Detectors

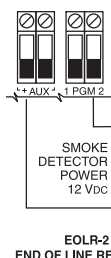

Smoke Detector must be latching type (e.g., DSC FSA 410B Series) To reset smoke detector, Enter [*] [7] [2]

Compatible 4-wire Smoke Detector
DSC FSA-410B Series

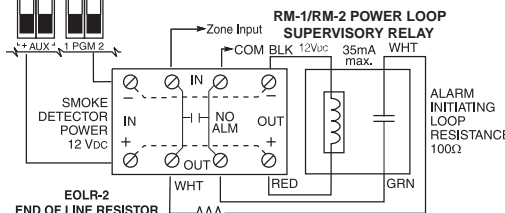

- FSA-410B
- FSA-410BT
- FSA-410BS
- FSA-410BST
- FSA-410BLST
- FSA-410BR
- FSA-410BRT
- FSA-410BR
- FSA-410BRST
- FSA-410BRST
- FSA-410BLRST

1.7 Telephone Line Wiring

Wire the telephone connection terminals (TIP, Ring, T-1, R-1) to an RJ-31x Connector as indicated. Use 26 AWG wire minimum for wiring.

For connection of multiple devices to the telephone line, wire in the sequence indicated.

Telephone format is programmed in section [350].

Telephone Call Directions are programmed in section [351]-[376].

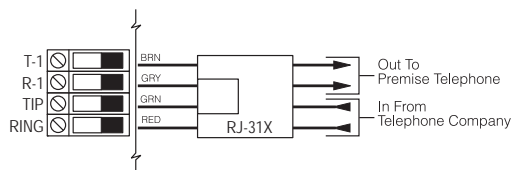

1.8 Ground

Ground Installation

Tighten nut to break paint and make good connection to the cabinet

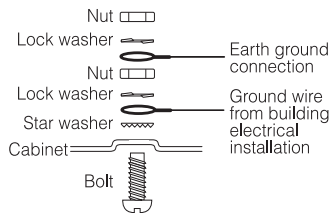

1.9 Battery

A sealed, rechargeable, lead acid battery or gel type battery is required to meet UL requirements for power standby times.

NOTE: UL Residential/Commercial Burglary installations require 4Hrs Power Standby time.

NOTE: UL/ULC Residential Fire & Health Care installations require 24 Hr. power standby. ULC Commercial Burglary and Fire monitoring installations require 24 Hr. power standby.

Standby Battery Guide

Battery Charging Current: 400 mA

Batt Size	Standby 4Hr	Standby 24Hr
4Ahr	700mA	----
7Ahr	700mA	180mA
14Ahr	700mA	470mA

NOTE:

Battery capacity will deteriorate with age and number of charge/discharge cycles. Replace every 3-5 years.

1.10 AC Wiring

AC Wiring

UL Listed Installations

Primary: 120VAC/ 60Hz./0.33A

Secondary:

16.5VAC/40VA

DSC PTD 1640U

Plug-in, Class 2

Transformer.

Use DSC PTD 1640U

for Canadian Installations

NOTE: Do not connect transformer to a receptacle controlled by a switch. (UL Listed Installations Only)

Section 2: User Commands

Any system keypad can be used to program or perform any keypad command. LED keypads use status and zone indicator lights to represent alarm functions and status. The LCD keypad displays the description and status indicator lights represent alarm functions and status. This section describes basic keypad commands. Refer to the PC1616/1832/1864 Reference Manual for detailed description of all keypad commands.

 Press the [#] key to reset the keypad if an error has been made entering user codes or keypad commands.

Section 2.1 – Away Arming

The Ready light must be **ON** to arm the system. If the Ready light is **OFF**, ensure all protected doors and windows are secure or bypassed. To arm the system in the Away mode, either press and hold the Away function button for 2 seconds or enter a valid user code and leave the premises through a door programmed as Delay. Upon arming, the Armed light will turn **ON**. If a user code was used to arm the system and Stay/Away zones are programmed, the Bypass light will turn **ON** and will turn **OFF** when a door programmed as Delay is violated. If the Audible Exit Delay option is enabled, the keypad will beep once every second during the exit delay (and three times a second during the last 10 seconds) to alert the user to leave.

Section 2.2 – Stay Arming

The Ready light must be **ON** to arm the system. If the Ready light is **OFF** ensure all protected doors and windows are secure or bypassed. To arm the system in the Stay mode, either press and hold the Stay function button for 2 seconds or enter a valid user code and stay within the premises (do **NOT** violate a door programmed as Delay). Upon arming, the Armed light and Bypass light will turn **ON**. If the Stay function button is used, the keypad will not beep during the exit delay. If a user code was used, the keypad will beep if the **Audible Exit Delay** option is enabled.

Section 2.3 – Disarming

The user must enter through a door programmed as Delay. Upon entering, the keypad will emit a steady tone (and emit a pulsing tone during the last 10 seconds of entry delay) to alert the user to disarm the system. Enter a valid user code to disarm the system. If an alarm occurred while the panel was armed, the Memory light and the zones that went into alarm will be flashing (LED keypad) or the keypad will display ‘Alarm in Memory’ (LCD keypad). Press the [#] key to return the keypad to the Ready state.

Section 2.4 – [*] Commands

The following is a list of the [*] commands available and a description of each:

[*][1]	Bypass (disarmed state)/Reactivate Stay/Away Zones (armed state)
[*][2]	Display Trouble Conditions
[*][3]	Display Alarm Memory
[*][4]	Door Chime Enable/Disable
[*][5]	User Code Programming
[*][6]	User Commands
[*][7][x]	Command Functions 1 – 4
[*][8]	Installer Programming
[*][9][code]	No-Entry Arming
[*][0]	Quick Arm (disarmed state)/Quick Exit (armed state)

[*][1] Bypass/Re-activate Stay/Away Zones

LED Keypad:

Press [*][1] to enter the bypass mode. If the Code Required for Bypass option is enabled, enter a valid user code. The Bypass light will flash. The keypad will turn **ON** the corresponding zone light to indicate a zone is bypassed. To bypass or unbypass a zone, enter the 2-digit zone number. Once the correct zones are bypassed, press [#] to exit. The Bypass light will be **ON** if any zones are manually bypassed.

LCD Keypad:

Press [*][1] to enter the bypass mode. If the Code Required for Bypass option is enabled, enter a valid user code. The keypad will display ‘Scroll to View Zones’. The keypad will display the programmed zone labels for the zones and include the letter ‘O’ in the bottom, right corner if the zone is violated or the letter ‘B’ if the zone is bypassed. Scroll to the appropriate zone and press the [*] key to change the bypass status (or enter the 2-digit zone number). Once the correct zones are bypassed, press [#] to exit.

Additional Bypass Commands:

Bypass Recall:	Press [99]. The keypad will recall the last group of zones that were bypassed
Clear Bypass:	Press [00]. The keypad will clear the bypass on all zones.
Save Bypass:	Press [95]. The keypad will save which zones are manually bypassed.
Recall Save:	Press [91]. The keypad will recall the bypassed zones that were saved.

 Hold Up Zones cannot be assigned to bypass groups.

Re-activate Stay/Away Zones:

Press [*][1] when the system is armed in the Stay mode to change the armed status to Away mode. The system will add the Stay/Away zones back into the system after the exit delay time expires.

[*][2] Trouble Display

Refer to Appendix D – Trouble Conditions, for troubleshooting assistance and a detailed description of all trouble conditions.

- i** Press [8] on any keypad or [*] on the trouble on any PK series keypad to enter the time and date programming menu. This option will be available if a Loss of Clock trouble is present on the system. A General System Supervisory caused by a hardwired or wireless zone expander cannot be overridden by this method. If Section [701] option 3 is ON arming will be inhibited if a system low battery or AC trouble is detected and cannot be overridden by this method.

[*][3] Alarm Memory Display

The Memory light will be ON if an alarm occurred during the last armed period. Press [*][3]. The Memory light will flash and the keypad will display the zones that went into alarm.

- i** : To clear the Memory light, arm then disarm the system.

[*][4] – Door Chime Enable/Disable

Press [*][4]. The keypad will emit 3 rapid beeps if the door chime feature is now enabled and a steady 2-second tone if it is now disabled. The same function can be performed by pressing and holding the Chime function button for 2 seconds.

[*][5] – Program User Codes

The following table identifies available user codes:

Code	Type	Function
[01]-[39], [41]-[95]	General User Codes	arm, disarm
[40]	Master Code	all functions

Programming User Codes:**LED Keypad:**

Press [*][5] followed by the Master Code. The Program light will flash. The keypad will turn ON the corresponding zone lights to indicate if any user codes are programmed. To add or change a user code, enter the 2-digit user code to be programmed. The zone light will flash. Enter a new 4 or 6-digit user code or press [*] to delete the user code. After the user code is programmed or deleted, the zone light corresponding to the user code will stop flashing. To add or change another user code, enter the 2-digit user code to be programmed or press [#] to exit.

LCD Keypad:

Press [*][5] followed by the Master Code. The keypad will display the first user (user 01) and include the letter 'P' in the bottom, right corner if the user code is programmed. Scroll to the appropriate user and press the [*] key to program the user (or enter the 2-digit user number). Enter a new 4 or 6-digit user code or press [*] to delete the user code. After the user code is programmed or deleted, scroll to another user or press [#] to exit.

Programming Partition Assignment:

Press [*][5] followed by the Master Code or Supervisor Code. Press [98] followed by the 2-digit user to change to the partition assignment. The keypad will turn ON the corresponding zone light to indicate which partition(s) the user is assigned to. For example, if zone light 1 is ON, the user is assigned to partition 1. To change the partition assignment, press the number corresponding to the partition. Once the correct partitions are assigned to the user, press [#] to exit. To change the partition assignment for another user, press [98] followed by the 2-digit user number. When finished, press [#] to exit.

Programming User Attributes:

Press [*][5] followed by the Master Code or Supervisor Code. Press [99] followed by the 2-digit user to change to the user attributes. The keypad will turn ON the corresponding zone light to indicate which attributes are assigned to the user.

Light [1]	User can enter User Code Programming section with this code
Light [2]	Duress Reporting Code is sent whenever this code is entered
Light [3]	User can manually bypass zones
Light [4]	User can access the Escort5580 module remotely
Light [5]	For Future Use
Light [6]	For Future Use
Light [7]	The panel will squawk the bell output when the user arms/disarms
Light [8]	One-time use code – Can disarm the system once per day and is reset at midnight.

To change the user attributes, press the number corresponding to the attribute. Once the correct attributes are assigned to the user, press [#] to exit. To change the user attributes for another user, press [99] followed by the 2-digit user number. When finished, press [#] to exit.

[*][6] – User Functions

Press [*][6] followed by the Master Code, then press the number corresponding to the following functions.

- [1] **Program Time and Date:** Enter the time and date using the following format [HH:MM] [MM/DD/YY]. Program the time using military standard (e.g., 8:00 pm = 20:00 hours).
- [2] **Auto-arm/Auto-disarm Enable/Disable:** The keypad will emit 3 rapid beeps if the Auto-arm/Auto-disarm feature is now enabled and a steady 2-second tone if it is now disabled.
- [3] **Auto-arm Time/Day:** Press the number corresponding to the day of the week (1=Sunday, 2=Monday etc.) followed by the auto-arm time (HH:MM). Program the time using military standard (e.g., 8:00 pm = 20:00 hours).
- [4] **System Test:** The panel will perform the following; activate the bell output, keypad buzzer and all keypad status lights for 2 seconds, test the backup battery and transmit a reporting code to the central station (if programmed).
- [5] **Enable DLS:** The panel will temporarily enable DLS for 1 or 6 hours depending on programming (see Sect [701] opt.[7]).
- [6] **User Initiated DLS:** The panel will attempt to call the DLS computer.
- [7] **For Future Use**
- [8] **For Future Use**

 **For LCD Keypads:** Scroll to the desired option then press [*]

Additional Alphanumeric Keypad Functions:

When scrolling through the list of available functions, the following additional functions are available:

Event Buffer:	Used to view the 500-event panel buffer
Brightness Control:	Used to adjust the display backlighting level for optimal viewing
Contrast Control:	Used to adjust the display contrast level for optimal viewing
Buzzer Control:	Used to adjust the keypad buzzer tone for optimal sound

[*][7][x] – Command Output (1-4)

Press [*][7][x]. If the Command Output Code Required option is enabled, enter a valid user code. The panel will activate any PGM output assigned to the command output.

[*][8] – Installer Programming

Press [*][8] followed by the Installer Code to enter Installer Programming. Refer to the 'How to Program' section for more information.

[*][9][User Code] – No-Entry Arming

Press [*][9] followed by a valid user code. The system will arm in the Stay mode and after the exit delay expires, it will remove entry delay. All zones programmed as Delay will function like Instant zones. The system will flash the Armed light to indicate that the system is armed with no entry delay.

[*][0] – Quick Arm/Quick Exit

Quick Arm: When disarmed, press [*][0] to arm the system. The system will arm as if a valid user code was entered.

Quick Exit: When armed, press [*][0] to activate Quick Exit. The system will allow a single zone programmed as Delay to be violated once during the following 2 minute time period without changing the status of the system.

Section 2.5 – Function Keys

Keypads have 5 programmable one-touch function buttons located in a column down the right-side of the keypad. These buttons can also be activated by pressing and holding number [1] through [5] respectively for 2 seconds. The default for these function buttons on the PK series keypads are as follows:

[1]	Stay Arm	[4]	Fire Reset – Command Output 2
[2]	Away Arm	[5]	Quick Exit
[3]	Chime Enable/Disable		

Section 3: Programming

This section provides the information necessary to program all required features for a basic system as well as common applications. Refer to the *PC1616/1832/1864 Reference Manual* for a complete description of all programmable features.

3.1 Template Programming

Selecting **[*][8][Installer Code][899]** displays the current 5 digit template programming code. Refer to Appendix C - Template Programming for a detailed description of available templates and corresponding 5 digit codes. After entering a valid 5 digit template programming code, you will be prompted to enter the following in the sequence indicated below:

 *This feature requires a PK55xx or RFK55xx series keypad, v.1.1 or higher.*

1. Central Station Telephone Number, enter 32 Character Telephone number

Program the required Central Station phone number. Press **[#]** to complete your entry if less than 32 digits. This phone number will be entered into programming section [301].

2. Central Station Account Code, enter 6-digit code

Program the required Central Station Account Code. Press **[#]** to complete your entry if less than 6 digits. This account code will be entered into programming section [310].

3. Partition Account Code, enter 4-digit code

This programming section will only be prompted if Contact ID has been selected as a communications format. Program the required Partition Account Code. This Partition account code will be entered into programming section [311].

4. DLS Access Code, enter 6-digit code

Program the required DLS Access Code. Press **[#]** to complete your entry if less than 6 digits. This Access Code will be entered into programming section [403].

5. Partition 1 Entry Delay 1, Partition 1 Exit Delay, enter each 3-digit delay time

Program the desired 3 digit Partition 1 Entry Delay (in seconds) followed by the desired 3 digit Partition 1 Exit Delay (in seconds). These values will be entered in programming section [005] sub-section [01] entry 1 and 3 respectively.

6. Installers Code

Enter the required 4 or 6 digit access code installers access code (dependent on Section [701] option 5). This Installer Access Code will be entered into programming section [006]. After the Installers Code has been programmed the keypad will return to base installers programming menu.

 *All template programming information must be re-entered after performing a hardware or software panel default.*

3.2 DLS Programming

3.2.1 Local Programming:

Follow the steps below in the sequence indicated to set up local programming using DLS:

1. Initiate downloading using the DLS software
2. Connect an RS-232 to PC-Link Cable between the Computer with DLS Software installed and the alarm panel to be programmed.

 *Connecting the DLS PC to the panel will automatically initiate the connection.*

3.2.2 Remote Programming (via telephone line):

Refer to Section [400] block on page 21 for details.

 *The panel battery voltage can be monitored with DLS software. After the panel information has uploaded, battery voltage can be viewed in the DLS session window.*

3.3 Advanced Keypad Programming

DSC recommends filling in the Programming Worksheet with the required programming information before programming the system. This will reduce the time required to program and will help eliminate errors.

To enter Installer Programming press **[*][8][Installer Code]**. The Program light will FLASH (programmable LCD keypad displays will change to 'Enter Section'). An error tone indicates the installer code entered is incorrect, Press **[#]** to clear any key presses and try again.

 *The default Installer Code is [5555].*

The Armed and Ready lights indicate programming status:

- Armed Light ON** Panel waiting for 3-digit section number
If in module programming, waiting for section # to be entered.
- Ready Light ON** Panel waiting for data to be entered
- Ready Light FLASHING** Panel waiting for HEX data to be entered

 You cannot enter installer programming while the system or any partition is armed or in alarm.

3.3.1 Programming Toggle Options:

Enter the 3-digit programming section number.:

- The Armed light will turn **OFF** and
- The Ready light will turn **ON**.
- The keypad will display which toggle options are **ON** or **OFF** according to the chart.
- To toggle an option **ON** or **OFF**, press the corresponding number on the keypad. The display will change accordingly.
- When all the toggle options are configured correctly, press the [#] key to exit the program section.
- The Ready light will turn **OFF** and the Armed light will turn **ON**.

Keypad Type	Option ON	Option OFF
LED	Zone Light ON	Zone Light OFF
Fixed-Message LCD	Indicator # ON	Indicator # OFF
Programmable-Message LCD	# Displayed	Dash [-] Displayed

3.3.2 Programming Decimal and Hexadecimal (HEX) Data:

- Enter the 3-digit programming section number.
- The Armed light will turn **OFF** and The Ready light will turn **ON**.
- Enter the data written in the boxes.

For sections that require multiple 2 or 3 digit numbers, the keypad will double-beep after each 2 or 3 digit entry and move to the next item in the list. After the last digit in the section is entered, the keypad will beep rapidly 5 times and exit the program section. The Ready light will turn **OFF** and the Armed light will turn **ON**.

For sections that do not require data for every box (such as phone numbers) press the [#] key to exit the program section after entering all the required data. The Ready light will turn **OFF** and the Armed light will turn **ON**.

At any time the [#] can be pressed to exit any program section. All changes made up to that point will be saved.

HEX (or hexadecimal) digits are sometimes required. To enter a HEX digit, press the [*] key to begin HEX programming. The Ready light will FLASH. Refer to the chart below and press the number corresponding to the HEX digit required. The Ready light will continue to FLASH. Press [*] again to return to normal decimal programming. The Ready light will turn **ON**.

Value	Enter	Telephone Dialer
HEX [A]	Press [*][1][*]	Not Supported
HEX [B]	Press [*][2][*]	Simulated [*] key
HEX [C]	Press [*][3][*]	Simulated [#] key
HEX [D]	Press [*][4][*]	Dial tone search
HEX [E]	Press [*][5][*]	Two second pause
HEX [F]	Press [*][6][*]	End of Number

 In addition to the standard digits 0-9, HEX digits and special dialer functions can also be programmed if required.

3.3.3 How to Exit Installer Programming:

To exit installer programming, press the [#] key when the panel is waiting for a 3-digit section number (the Armed light is **ON**).

3.3.4 Viewing Programming

LED and LCD5501Z Keypads

Any programming section can be viewed from an LED or LCD5501Z keypad. When a programming section is entered, the keypad will immediately display the first digit of information programmed in that section. The keypad displays the information using a binary format, according to the following chart:

Press any of the Emergency keys (Fire, Auxiliary or Panic) to advance to the next digit.

When all the digits in a section have been viewed, the panel will exit the section: the Ready light will turn **OFF**, and the Armed light will turn **ON**, waiting for the next 3-digit programming section number to be entered.

Press the [#] key to exit the section

LCD Keypad

The keypad will immediately display all the information programmed when a programming section is entered. Use the arrow keys (<>) to scroll through the data being displayed. Scroll past the end of the data displayed, or press the [#] key to exit the section.

Please See Hex Data Entry Instructions Below

Value	0	1	2	3	4	5	6	7	8	9	A	B	C	D	E	F
Zone 1	<input type="checkbox"/>	<input checked="" type="checkbox"/>	<input type="checkbox"/>	<input checked="" type="checkbox"/>	<input type="checkbox"/>	<input checked="" type="checkbox"/>	<input type="checkbox"/>	<input checked="" type="checkbox"/>	<input type="checkbox"/>	<input checked="" type="checkbox"/>	<input type="checkbox"/>	<input checked="" type="checkbox"/>	<input type="checkbox"/>	<input checked="" type="checkbox"/>	<input type="checkbox"/>	<input checked="" type="checkbox"/>
Zone 2	<input type="checkbox"/>	<input type="checkbox"/>	<input checked="" type="checkbox"/>	<input type="checkbox"/>	<input checked="" type="checkbox"/>	<input type="checkbox"/>	<input checked="" type="checkbox"/>	<input type="checkbox"/>	<input checked="" type="checkbox"/>	<input type="checkbox"/>	<input checked="" type="checkbox"/>	<input type="checkbox"/>	<input checked="" type="checkbox"/>	<input type="checkbox"/>	<input checked="" type="checkbox"/>	<input type="checkbox"/>
Zone 3	<input type="checkbox"/>	<input type="checkbox"/>	<input type="checkbox"/>	<input checked="" type="checkbox"/>	<input type="checkbox"/>	<input checked="" type="checkbox"/>	<input type="checkbox"/>	<input checked="" type="checkbox"/>	<input type="checkbox"/>	<input checked="" type="checkbox"/>	<input type="checkbox"/>	<input checked="" type="checkbox"/>	<input type="checkbox"/>	<input checked="" type="checkbox"/>	<input type="checkbox"/>	<input checked="" type="checkbox"/>
Zone 4	<input type="checkbox"/>	<input type="checkbox"/>	<input type="checkbox"/>	<input type="checkbox"/>	<input checked="" type="checkbox"/>	<input type="checkbox"/>	<input checked="" type="checkbox"/>	<input type="checkbox"/>	<input checked="" type="checkbox"/>	<input type="checkbox"/>	<input checked="" type="checkbox"/>	<input type="checkbox"/>	<input checked="" type="checkbox"/>	<input type="checkbox"/>	<input checked="" type="checkbox"/>	<input type="checkbox"/>

Zone Light OFF
 Zone Light ON

Section 4 – Programming Descriptions

The following is a brief description of the features and options available in the Power PC1616/1832/1864 control panel. Refer to the *PC1616/1832/1864 Reference Manual* for a complete description of all programming features, limitations and requirements.

Section [001] to [004] Zone Definitions

Option	Description
[00]	Null Zone: Zone not used
[01]	Delay 1: When armed, provides entry delay when violated (follows Entry Delay 1)
[02]	Delay 2: When armed, provides entry delay when violated (follows Entry Delay 2)
[03]	Instant: When armed, instant alarm when violated
[04]	Interior: When armed, instant alarm if the zone is violated first, will follow entry delay if entry delay is active
[05]	Interior Stay/Away: Similar to 'Interior' except panel will auto-bypass the zone if Armed in the Stay mode
[06]	Delay Stay/Away: Similar to 'Delay 1' except panel will auto-bypass the zone if Armed in the Stay mode
[07]	Delayed 24-Hour Fire (Hardwire): Instant audible alarm when violated, communication delayed 30 seconds - if alarm acknowledged during this time (by pressing a key), the alarm will be silenced 90 seconds and repeat cycle - if not, alarm will latch and communicate after 30 second delay
[08]	Standard 24-Hour Fire (Hardwire): Instant alarm and communication when violated
[09]	24-Hour Supervision (Hardwire): Instant alarm and communication when violated. Will not sound the bell or keypad buzzer.
[10]	24-Hour Supervisory Buzzer: Instant alarm, panel will activate keypad buzzer instead of bell output
[11]	24-Hour Burglary: Instant alarm when violated, audible alarm at default. Reporting code BA, BH
[12]	24-Hour Hold-Up: Instant alarm when violated, silent alarm at default. Reporting code HA, HH
[13]	24-Hour Gas: Instant alarm when violated, audible alarm at default. Reporting code GA, GH
[14]	24-Hour Heat: Instant alarm when violated, audible alarm at default (also known as high-temp). Reporting code KA, KH
[15]	24-Hour Medical: Instant alarm when violated, silent alarm at default. Reporting code MA, MH
[16]	24-Hour Panic: Instant alarm when violated, audible alarm at default. Reporting code PA, PH
[17]	24-Hour Emergency: Instant alarm when violated, audible alarm at default. Reporting code QA, QH
[18]	24-Hour Sprinkler: Instant alarm when violated, audible alarm at default. Reporting code SA, SH
[19]	24-Hour Water: Instant alarm when violated, audible alarm at default (also known as high water level). Reporting code WA, WH
[20]	24-Hour Freeze: Instant alarm when violated, audible alarm at default (also known as low-temp). Reporting code ZA, ZH
[21]	24-Hour Latching Tamper: Instant alarm when violated, panel cannot be armed until Installer Programming is entered
[22]	Momentary Keyswitch Arm: Arm or disarm the system when violated
[23]	Maintained Keyswitch Arm: Arm system when violated, disarm system when restored
[24]	For Future Use
[25]	Interior/Delay: Zone will function like an Interior zone when armed in Away mode, like a Delay zone when armed in the Stay mode
[26]	24-Hour Non-Alarm: Zone will NOT create an alarm. Can be used with zone follower function for automation applications
[29]	Auto-Verified Fire: When violated, system will reset all smoke detectors for 20 seconds, then wait 10 seconds for detectors to settle. If another fire alarm detected within 60 seconds zone will go into alarm immediately
[30]	Supervisory: Instant alarm, system will activate keypad buzzer. A valid user code is required to silence Keypad buzzer.
[31]	Day Zone: Instant alarm when system is armed, keypad buzzer (no alarm) when system is disarmed
[32]	Instant Stay/Away: Similar to 'Instant' except panel will auto-bypass the zone if Armed in the Stay mode
[35]	24-Hour Bell/Buzzer: Instant alarm when violated, system will activate bell output if armed, keypad buzzer if disarmed

- [36] **24-hr. Non-Latching Tamper Zone:** Instant tamper condition when violated. Active in both the armed and disarmed state.
- [37] **Night Zone:** Functions like Interior Stay/Away but will remain bypassed if the user presses [*][1] to re-activate Stay/Away zones when armed in the Stay mode
- [87] **Delayed 24-Hour Fire (Wireless/Addressable):** Same as Delayed 24-Hour Fire (Hardwire) but must be used for wireless or addressable smoke detectors
- [88] **Standard 24-Hour Fire (Wireless/Addressable):** Same as Standard 24-Hour Fire (Hardwire) but must be used for wireless or addressable smoke detectors

Section [005] System Times

After entering Section [005], enter the 2-digit subsection number for the desired partition and program the **Entry Delay 1**, **Entry Delay 2** and **Exit Delay** for each active partition on the system. Valid entries are from [001] to [255] or [045] to [255] for SIA CP-01 panels (in seconds). Enter subsection [09] to program the **Bell Cut-Off Time**. Valid entries are from [001] to [255] (in minutes).

Section [006] Installer Code

The default Installer Code is [5555] or [555555] if 6-Digit Access Codes is enabled.

Section [007] Master Code

The default Master Code is [1234] or [123456] if 6-digit Access Codes is enabled.

Section [008] Maintenance Code

The default Maintenance Code is [AAAA] (not programmed). This code can arm any partition but cannot disarm unless the partition is in alarm.

Section [009] to [011] PGM Outputs

The PC1616 and PC1832 have two on-board PGM outputs (PGM1 and PGM2). The PC1864 has four on-board PGM outputs (PGM1 to PGM4). The panel has the capacity for up to 14 PGM outputs (8 additional low-current PGM outputs with PC5208 module, 4 additional high-current PGM outputs with a PC5204 module).

PGM Output Options:

Option	Description
[00]	For Future Use
[01]	Fire and Burglary: Output will activate (steady for burglary, pulsing for fire) if an alarm occurs on the selected partition
[02]	For Future Use
[03]	Sensor Reset: Output will normally be active and deactivate for 5 seconds when a [*][7][2] fire reset command is entered or when an Auto-Verify Fire alarm is detected
[04]	2-Wire Smoke: Configures PGM2 as 2-wire smoke detector input (PGM2 only)
[05]	Armed Status: Output will activate when all of the selected partitions are armed
[06]	Ready Status: Output will activate when all the selected partitions are in the Ready state (Ready light ON)
[07]	Keypad Buzzer Follow: Output will activate and follow the keypad buzzer for the selected partition when the following events occur; entry delay, door chime, audible exit delay, automatic arming pre-alert, 24-Hour Supervisory Buzzer zone alarm
[08]	Courtesy Pulse: Output will activate during entry/exit delay if the selected partition is armed – will remain active for an additional 2 minutes after the entry or exit delay expires
[09]	System Trouble: Output will activate when any selected trouble condition is present
[10]	Latched System Event (Strobe): Output will activate when a selected condition occurs on any selected partition. Note output can be programmed to follow timer
[11]	System Tamper: Output will activate when any tamper condition is present
[12]	TLM and Alarm: Output will activate if a telephone line trouble is present and then an alarm occurs
[13]	Kissoff: Output will activate for 2 seconds when a valid kissoff is received from the central station
[14]	Ground Start: Output will activate for 2 seconds when the panel attempts to seize the phone line (additional dial tone search must be programmed in the central station phone number – HEX [D])
[15]	Remote Operation: Output can be activated/deactivated via the DLS software
[16]	For Future Use
[17]	Away Armed Status: Activates when all of the selected partitions are armed in Away mode

- [18] **Stay Armed Status:** Activates when all of the selected partitions are armed in Stay mode
 - [19] **Command Output 1:** Activates when a [*][7][1] command is entered on the selected partition – Command can be programmed to require a valid access code and output can be programmed to activate for the time programmed in Section [170] or programmed to latch.
 - [20] **Command Output 2:** Activates when a [*][7][2] command is entered on the selected partition – Command can be programmed to require a valid access code and output can be programmed to activate for the time programmed in Section [170] or programmed to latch.
 - [21] **Command Output 3:** Activates when a [*][7][3] command is entered on the selected partition – Command can be programmed to require a valid access code and output can be programmed to activate for the time programmed in Section [170] or programmed to latch.
 - [22] **Command Output 4:** Activates when a [*][7][4] command is entered on the selected partition – Command can be programmed to require a valid access code and output can be programmed to activate for the time programmed in Section [170] or programmed to latch.
 - [23] **Silent 24-Hour Input:** Changes PGM to a 24-Hour Silent zone (PGM2 only)
 - [24] **Audible 24-Hour Input:** Changes PGM to a 24-Hour Audible zone (PGM2 only)
 - [25] **Delayed Fire and Burglary:** Functions as a Fire and Burglary output but does not activate until the TX Delay time expires
 - [26] **Battery Test Output:** Output activates for 10 seconds at midnight each day.
 - [28] **Holdup Output:** Activates when a Holdup Alarm occurs on any assigned partition. Remains active until all assigned partitions have been armed or disarmed. Will not activate if a Holdup Zone is goes into a fault or tamper condition.
 - [29] **Zone Follower (Zones 1-8):** Active when any of the selected zones are active and deactivates when all of the selected zones are restored.
 - [30] **Partition Status Alarm Memory:** Activates if the selected partition is armed. Output will pulse “one second ON / one second OFF if an alarm occurs
 - [31] **Alternate Communicator:** Activates when selected system event occurs. If active in the armed state, it remains active until the system is disarmed. If activated in the disarmed state, it remains active until a valid access code is entered within bell cut-off time, or when the system is armed after bell cut-off time has expired.
 - [32] **Open After Alarm:** Activates for 5 seconds when system has been disarmed after an alarm.
 - [33] **Bell Status and Programming Access Output:** Activates when Bell, Installer programming mode or DLS is active. Remains active until Bell is no longer active, Installer programming mode is exited and DLS programming is disconnected.
 - [34] **Away Armed with no Zone Bypassed Status:** Activates when armed with stay/away zones active and no zones bypassed.
 - [35] **Zone Follower (Zones 9-16):** Active when any of the selected zones are active and deactivates when all of the selected zones are restored.
 - [36] **Zone Follower (Zones 17-24):** Active when any of the selected zones are active and deactivates when all of the selected zones are restored.
 - [37] **Zone Follower (Zones 25-32):** Active when any of the selected zones are active and deactivates when all of the selected zones are restored.
 - [38] **Zone Follower (Zones 33-40):** Active when any of the selected zones are active and deactivates when all of the selected zones are restored.
 - [39] **Zone Follower (Zones 41-48):** Active when any of the selected zones are active and deactivates when all of the selected zones are restored.
 - [40] **Zone Follower (Zones 49-56):** Active when any of the selected zones are active and deactivates when all of the selected zones are restored.
 - [41] **Zone Follower (Zones 57-64):** Active when any of the selected zones are active and deactivates when all of the selected zones are restored.
- * See Section [501]-[514] Programmable Output Attributes, PGM Output Option [29] and [35]-[41] option 8 on page 23

Section [012] Keypad Lockout

The system can be programmed to ‘lockout’ keypads if a series of incorrect user or installer codes are entered. When lockout is active, all keypads emit a steady 2-second error tone when a key is pressed. Program the Number of Invalid Codes Before Lockout with the desired number. Valid entries are from [000] to [255]. Program data [000] to disable the feature. Keypads will remain locked out for the number of minutes programmed for the Lockout Duration. Valid entries are from [000] to [255].

Section [013] First System Option Code

Option Description

- [1] **ON:** zones require normally-closed loops. **OFF:** zones require 5.6K End-Of-Line resistors.
- [2] **ON:** zones require double End-Of-Line resistors. **OFF:** zones require single End-Of-Line resistors.
- [3] **ON:** keypads will display all trouble conditions while armed. **OFF:** keypads will only display fire trouble when armed.
 This option must be **OFF** if LCD5500 v2.x (or older) keypads are used on the system.
- [4] **ON:** only a trouble will be displayed. **OFF:** keypads will display a trouble and a zone violation if a tamper or fault is detected.

- [5] **ON:** auto-arming schedules (Program Sections [181]-[188]) will be available to the user in the [*][6] menu.
OFF: auto-arming schedules will **NOT** be available to the user in the [*][6] menu.
- [6] **ON:** the Audible Exit Fault feature will be enabled. If a delay zone is not secured correctly and not force-armed, at the end of the exit delay, the system will go into entry delay and turn **ON** the bell output. The bell will also sound if the delay zone is opened within 10 seconds of the exit delay timeout. **OFF:** the keypad will sound the entry delay through the keypad as normal.
- [7] **ON:** the system will **NOT** log additional alarms for a zone that has reached the swinger shutdown threshold.
OFF: all zone alarms will be logged.
- [8] **ON:** Temporal Three Fire Signal is used to annunciate fire alarms
(½ second ON, ½ second OFF, ½ second ON, ½ second OFF ½ second ON, 1 ½ seconds OFF).
OFF: the system will pulse the bell output
(½ second ON, ½ second OFF).

Section [014] Second System Option Code

Option	Description
--------	-------------

- | | |
|-----|---|
| [1] | ON: the system squawks the bell output once when a partition is armed, twice when disarmed. OFF: the bell output does not activate. Refer to section [017] option 8. |
| [2] | ON: the system squawks the bell output every 10 seconds during the auto-arm pre-alert. OFF: the bell output does not activate. |
| [3] | ON: the system will squawk the bell output once every second during Exit Delay , 3 squawks per second for the last 10 seconds.
OFF: the bell output will not activate. |
| [4] | ON: the system will squawk the bell output once every second during Entry Delay , 3 squawks per second for the last 10 seconds.
OFF: the bell output will not activate. |
| [5] | ON: the system squawks the bell output once every 10 seconds when a trouble condition is present.
OFF: the bell output does not activate. |
| [6] | ON: the system will beep the keypads once every second, and 3 times a second during the last 10 seconds, during exit delay when the system is armed with a user code or armed in the Away mode. OFF: the keypads will not beep. |
| [7] | ON: the exit delay will be terminated (reduced to 5 seconds) when a Delay 1 zone is violated and restored after the system is armed.
OFF: the exit delay will count down as normal. |
| [8] | ON: the bell output will not timeout if a fire alarm occurs. The user must turn OFF the bell by entering a valid user code.
OFF: the bell output will timeout normally. |

Section [015] Third System Option Code

Option	Description
--------	-------------

- | | |
|-----|--|
| [1] | ON: the keypad [F] fire emergency key will be enabled. OFF: the keypad [F] fire emergency key will be disabled. |
| [2] | ON: the keypad [P] panic emergency will be audible (bell output). OFF: the keypad [P] emergency key will be silent. |
| [3] | ON: the Quick Exit feature will be enabled. OFF: the Quick Exit feature will be disabled. |
| [4] | ON: the Quick Arming [*][0] feature will be enabled. OFF: Quick Arming [*][0] feature will be disabled.
 If this feature is disabled, a valid user code must be entered after the Stay or Away function buttons are pressed. |
| [5] | ON: a valid user code must be entered after pressing [*][1] to access the Bypass feature. OFF: a user code is not required. |
| [6] | ON: the Master Code (user code 40) can only be changed in Installer Programming. OFF: the Master Code can be changed using the User Programming [*][5] command. |
| [7] | ON: the system supervises the telephone line and displays a trouble if disconnected. OFF: the telephone line is not supervised. |

- [8] **ON:** the system activates the bell output if a telephone line trouble is detected while the system is armed. **OFF:** the system activates the keypad buzzer trouble tone.

Section [016] Fourth System Option Code

Option	Description
--------	-------------

- | | |
|-----|--|
| [1] | ON: the system supervises the AC input and displays a trouble if a failure is detected. OFF: AC Input is not supervised. |
| [2] | ON: the trouble light will flash when an AC trouble is detected. OFF: the trouble light turns on, does not flash. |
| [3] | ON: the keypad blanks (no indicator lights) if a key is not pressed for 30 seconds. OFF: the keypad does not blank. |
| [4] | ON: a valid user code must be entered to restore normal keypad operation after the blanking. OFF: pressing any key will return the keypad to normal operation. |
| [5] | ON: keypad backlighting enabled. OFF: keypad backlighting disabled. |
| [6] | ON: the system temporarily enables the Keypad Blanking feature if an AC failure is detected (to preserve the back up battery). OFF: the system will operate as normal. |
| [7] | ON: the keypad turns ON the Bypass light if zones are bypassed while the system is armed. OFF: the Bypass light turns OFF when the system is armed. |
| [8] | ON: the system supervises keypad tampers. OFF: the system does not supervise keypad tampers. |

Section [017] Fifth System Option Code

Option	Description
--------	-------------

- | | |
|-----|--|
| [1] | ON: the system does NOT associate wireless keys to user codes. OFF: the system will assign user code 17 to wireless key #01, user code 18 to wireless key #02 etc. If the wireless key is used to arm or disarm, the system will report the Opening or Closing for the associated User Code. |
| [2] | ON: the system logs an RF Jam trouble condition if the condition is present for 5 minutes. OFF: the system logs the trouble condition after 30 seconds. |
| [3] | ON: the keypads beep if an RF Jam trouble is detected. OFF: the trouble is not annunciated via the keypad buzzer. |
| [4] | ON: the Double Hit feature will be enabled. Two violations from the same zone within the Cross Zone Timer will be considered a valid Police Code or Cross Zone event. The system will report the event and log it to the event buffer.
OFF: two alarms from the same zone is not a valid Police Code or Cross Zone event. |
| [5] | ON: the system logs and communicates a Late-To-Close event when it auto-arms at the programmed time (not if auto arming was caused by the No-Activity Arming feature). OFF: the system does not transmit or log a Late-To-Close event. |
| [6] | ON: enables the Daylight Savings automatic clock adjustment feature. OFF: the system does not automatically adjust the clock for Daylight Savings. |
| [7] | For Future Use |
| [8] | ON: the system only squawks the bell output when the system is armed in the Away mode. OFF: the system squawks the siren when the system is armed in any mode. (See Section [14]). |

Section [018] Sixth System Option Code

Option	Description
--------	-------------

- | | |
|---------|--|
| [1] | ON: the system only transmits a Test Transmission reporting code if no other event was transmitted to the central station during the programmed time. OFF: the system always transmits a Test Transmission reporting code as programmed. |
| [2]-[4] | For Future Use |
-

- [5] **ON:** the keypad buzzer follows the bell output for all alarms. **OFF:** the system only activates the bell output for all alarms.
- [6] **ON:** When an alarm is detected on a zone (with the Cross Zone attribute enabled), a timer is started. The alarm is not transmitted and the bell output is not activated unless a second cross zone enabled zone is violated before the Cross Zone timer times out. **OFF:** the system reports all alarms normally and logs and transmits a Police Code reporting code if a second zone alarm is detected during the armed period.
- [7] **ON:** The system restarts the Exit Delay (one time) if a Delay zone is violated and restored during the exit delay time. **OFF:** exit delay does not restart.
- [8] **ON:** The system activates the trouble beeps when an AC trouble is detected. **OFF:** the system does not annunciate AC troubles using the keypad buzzer.

Section [019] Seventh System Option Code

Option Description

- [1] **For Future Use**
- [2] **ON:** Trouble light latches on **OFF:** Trouble light turns off after restore.
- [3] **ON:** When disarming, the keypad will display only the first alarm to occur during the last arming period **OFF:** When disarming, the keypad will display all zones that were in alarm during the last arming period
- [4]-[5] **For Future Use**
- [6] **ON:** the green LED indicator on the keypads indicate the status of AC on the system **OFF:** the green LED indicator on the keypads indicate the partition ready status
- [7] **ON:** All user access codes can enter the User Functions menu. **OFF:** Only the Master Code can enter the User Functions menu.
- [8] **For Future Use**

Section [020] Keypad Zone Assignment

Enter the two-digit zone number to be assigned to each keypad assigned to a specific slot. Only one keypad can be assigned to a specific slot. See Keypad Assignment. Valid entries are from [00] to [64].

Section [021] Eighth System Option Code

Option Description

- [1] **ON:** Access codes will not be accepted by the system during entry delay. **OFF:** An access code can be used to disarm the system during entry delay
- [2]-[5] **For Future Use**
- [6] **ON:** Key-switches and wireless can only disarm the system during an entry delay **OFF:** Key-switches and wireless keys can disarm the system regardless if entry delay is active or not.
- [7]-[8] **For Future Use**

Section [022] Ninth System Option Code

Option Description

- [1] **ON:** An access code is required for access to the [*][1], [*][2], [*][3] menus. **OFF:** No access code is required for [*][1], [*][2], [*][3] menu access.
- [2]-[3] **For Future Use**
- [4] **ON:** Only the Master code can be used to bypass a hold up zone. **OFF:** Any valid access code can bypass a hold up zone.

- [5] **For Future Use**
- [6] Refer to the *PC1616/PC1832/PC1864 Reference Manual* for **RF Delinquency** details.
- [7] **Future Use**
- [8] **ON:** When the system is armed in Stay mode, during the Exit delay, the system will sound 1 beep every 3 second.
OFF: When the system is armed in Stay mode, the system will be silent during the Exit delay.

Section [023] Tenth System Option Code

Option	Description
--------	-------------

- | | |
|-----|---|
| [1] | ON: the keypad [F] emergency key will only beep three times to acknowledge the button has been pressed. The system will not activate the bell output. OFF: the system will activate the bell output and beep the keypad. |
| [2] | Refer to the <i>PC1616/PC1832/PC1864 Reference Manual</i> for 200 Baud Open/Close Identifier details. |
| [3] | ON: the system will only transmit the Test Transmission reporting code if the system is armed at the time the system is programmed to report the event. OFF: the system will always report the Test Transmission reporting code at the programmed time. |
| [4] | ON: the system changes the Test Transmission Reporting Cycle Time from Days to Hours . OFF: the Test Transmission Reporting Cycle Time is in Days . |
| [5] | ON: the user cannot switch from Away Arm mode to Stay Arm mode using the function keys. OFF: the user can switch arming modes. |
| [6] | ON: the system disconnects a listen in/two-way session if a new event occurs.
OFF: the system does NOT disconnect. New events are transmitted only after the session is terminated. |
| [7] | ON: the system does NOT activate the keypad buzzer for any trouble condition (excluding Fire Troubles). OFF: the system annunciates troubles via the keypad buzzer (two beeps every 10 seconds) normally. |
| [8] | ON: Keyswitches will always arm in away mode. OFF: Keyswitches will arm in away mode if an entry/exit zone is violated during exit delay. |

Section [030] Fast Loop Response

This section is used to determine the Loop Response Time for the main panel zones.

ON: the loop response time will be 36 mS. **OFF:** the loop response time will be 400 mS.

Section [101] to [164] Zone Attributes

These sections are used to customize the operation of the zones. There are 9 toggle options in each Section:

Option	Description
--------	-------------

- | | |
|-----|--|
| [1] | ON: alarms are audible (bell output). OFF: alarms are silent. |
| [2] | ON: the bell output is steady (burglary). OFF: the alarm output pulses (fire). |
| [3] | ON: a zone violation or restoral will activate Chime. OFF: Chime is not activated. |
| [4] | ON: the user can manually bypass the zone using the [*][1] command. OFF: the zone cannot be manually bypassed. |
| [5] | ON: the partition can be armed even if the zone is violated (the zone will not affect the Ready status). OFF: the zone must be secure before arming. |
| [6] | ON: the system shuts down alarm reporting after the programmed number of alarms have occurred. OFF: the panel will always report the event if an alarm occurs. |
| [7] | ON: the system delays reporting the event for the time programmed for the Transmission Delay time. OFF: the panel immediately transmits the reporting event when an alarm is detected. |
| [8] | ON: the zone is a wireless or addressable device. OFF: the zone is a hardwire zone (main panel, zone expander or keypad zone). |

[9] **ON:** the zone has the Cross Zone feature enabled. **OFF:** the zone functions normally.

[10]-[13] For Future Use

[14] **ON:** the zone requires a normally-closed loop **OFF:** the zone will follow the EOL configuration in Section [013]

[15] **ON:** the zone requires a single End-of-Line resistor **OFF:** the zone will follow the EOL configuration in Section [013]

[16] **ON:** the zone requires a double End-of-Line resistors **OFF:** the zone will follow the EOL configuration in Section [013]

Options 14, 15, 16 apply to first 8 zones only. If more than one of these options are enabled then lowest numbered option is enabled. E.g., If Option 14 and option 15 are enabled then the zones are configured as normally closed loops.



Keypad zones and zone expanders will always follow Section [013].

When Zone Types (Section [001] to [004]) are programmed, the system will change the Zone Attributes to those found in the chart included in the Programming Worksheets. The Zone Attributes will default if a new Zone Type is programmed for a specific zone. After programming the Zone Types, enter Section [101] to [164] and ensure that all options are programmed correctly.

Ready light **ON:** Program attributes [1-8] (press [1]-[8] to turn option **ON** or **OFF**)

Ready light and Armed light **ON:** Program attributes [9-16] (press [1]-[8] to turn option **ON** or **OFF**)

Press [9] to switch between attributes [1-8] and attribute [9-16].

Section [165] Maximum Dialing Attempts

Program the Maximum Dialing Attempts before the panel will generate a Failure to Communicate (FTC) trouble condition.

Valid entries are [001] to [005]. For UL Listed installations, 5 attempts is required.

Section [166] Post Dial Wait for Handshake

Program the maximum time the panel will wait, after dialing, for a valid handshake from the central station.

Valid entries are [001] to [255] seconds.

Section [167] T-Link Communications Wait for Acknowledgement

Program the maximum time the panel will wait, after sending a data packet, for an acknowledgement from the central station.

Valid entries are [001] to [255] seconds.

Section [168] Daylight Savings Time (Move Clock Ahead)

These sections are used to program the Date, Time and Increment that the clock will move ahead for Daylight Savings Time each year. Programming can be accomplished by programming the Month, Day, Hour and Increment or Month, Week, Day of Week, Hour and Increment:

Month Data [001] to [012] represents January to December.

Week Data [000] indicates that the day of the month will be programmed in the **Day** section below. Data [001] to [005] represents weeks 1 to 5 of the month. Week 5 always represents the last week in the month, regardless if the number of weeks in the month is 4 or 5.

Day Data [001] to [031] represents day of the month if [000] was programmed in the **Week** section above. If [001] to [005] was programmed in the **Week** Section above, then Data [000] to [006] represents Sunday to Saturday

Hour Data [000] to [022] represents the hour that Daylight Saving Time will take effect.

Increment Data [001] to [002] represents the number of hours to advance the clock for Daylight Savings Time.



Do not program the **Hour** outside of the valid range or the time will not change. Do not program the value of the **Increment** to be greater than the number of hours remaining in the current day.

Section [169] Standard Time (Set Clock Back)

These sections are used to program the Date, Time and Increment that the clock will move back for Standard Time each year. Programming can be accomplished by programming the Month, Day, Hour and Increment or Month, Week, Day of Week, Hour and Increment:

Month Data [001] to [012] represents January to December.

Week Data [000] indicates that the day of the month will be programmed in the **Day** section below. Data [001] to [005] represents weeks 1 to 5 of the month. Week 5 always represents the last week in the month, regardless if the number of weeks in the month is 4 or 5.

Day Data [001] to [031] represents day of the month if [000] was programmed in the **Week** section above. If [001] to [005] was programmed in the **Week** Section above, then Data [000] to [006] represents Sunday to Saturday

Hour Data [000] or [023] represents the hour that Standard Time will take effect.

Increment Data [001] or [002] represents the number of hours to roll back the clock for Daylight Savings Time.

Section [170] PGM Output Timer

Program the time, in seconds, PGM outputs programmed to follow the PGM Output Timer will activate for. Valid entries are [001] to [255].

Section [171] Tamper PGM Output Timer

Program the time, in minutes, that a tamper condition will latch the Tamper PGM output. Valid entries are [000] to [255].

Section [175] Auto-arm Postpone Timer

Program the time, in minutes, that the system will postpone automatic arming. After the programmed time, the system will attempt to auto arm again. If data [000] is programmed, the system will instead abort the auto arm sequence. Valid entries are [001] to [255].

Section [176] Cross Zone/Police Code Timer

Program the time, in seconds (Cross Zone) or minutes (Police Code), that the panel will use to determine if a Cross Zone or Police Code event has occurred. If data [000] is programmed when using the Police Code feature, the panel will generate a Police Code event if any two zones go into alarm during any armed-to-armed period. Valid entries are [001] to [255].

Section [181] to [188] Auto-arm Schedules

Program the time to auto arm (section [181] for partition 1, Section [182] for partition 2 etc.) for each day of the week. Each section has seven, 4-digit entries, two digits for the hour, two digits for the minute, for Sunday through Saturday. Program using the military format (for example, to auto arm at 8:00 pm program data [20][00]). Valid entries are [00][00] to [23][59] – program [99][99] to disable auto arming.

Section [190] No Activity Arming Pre-alert Duration

Program the time, in minutes, for the No Activity Arming Pre-Alert Duration. The keypads will provide a steady tone warning the user that the system will arm. The user can either violate a zone or press any key to abort the arming sequence. Valid entries are [000] to [255].

Section [191] to [198] No Activity Arm Timer

Program the time, in minutes, for the No Activity Arm Timer (Section [191] for Partition 1, Section [192] for Partition 2 etc.). If Delay Zones are restored and no zone activity is detected for the time programmed, the system will start the auto arm sequence. Valid entries are [000] to [255].

Section [199] Auto-Arming Pre-alert Timer

Program the time, in minutes, for the Auto-Arming Pre-Alert Time. This timer is used for all programmed auto-arming features (is not used for No Activity Arming). The keypads will provide a steady tone warning the user that the system will arm. The user can enter a valid access code to abort the arming sequence. Valid entries are [001] to [255].

Section [201] Partition Selection Mask

Turn the corresponding option **ON** to enable partitions [1] to [8]. **ON** (bit 1 cannot be turned **OFF**).

Section [202] to [265] Partition Zone Assignments

These Sections are used to assign zones to specific partitions (Section [202] to [209] for Partition 1, Sections [210] to [217] for Partition 2 etc.). Turn **ON** the option corresponding to the partition and zone to enable the zone on the specified partition. Turn the option **OFF** to disable the zone on the specified partition. Zones assigned to more than one partition are called 'common zones' and will only be armed if all the partitions the zone is assigned to are armed. Default = Zones 1-8 enabled on Partition 1.

Section [301] to [303] Telephone Numbers

Program the phone numbers as required. Phone Number 3 is dedicated as a back-up to Phone Number 1. HEX digits can be included for special applications:

HEX [A]	Not used
HEX [B]	Simulates a [*] key press
HEX [C]	Simulates a [#] key press
HEX [D]	Additional dial tone search
HEX [E]	2-second pause
HEX [F]	End of phone number marker

Section [304] Call Waiting Cancel String

Program the digits required to disable call waiting. If enabled, the system will dial the programmed string on the first dialing attempt. Program unused digits with data [F].

Section [310] System Account Number

Program the System Account Number. Only the SIA format supports 6-digit account numbers. If a 4-digit account number is required, program the last two digits as data [FF]. If using the SIA format, this account number will be used for all reporting events. If using a

different format, this account number will be used for all events that are not partition specific (for example, low battery, AC trouble etc.). For partition specific events the system will use the programmed Partition Account Number. For all formats other than SIA, program a HEX [A] for any digit [0] in the account number being used.

Section [311] to [318] Partition Account Numbers

Program the Partition Account Number for each active partition (Section [311] for partition 1, Section [312] for partition 2 etc.). When using the Automatic SIA format, these account numbers are not used. The system will use the System Account Number for all reporting events. For all formats other than SIA, program a HEX [A] for any digit [0] in the account number being used.

Section [320] to [349] Reporting Codes

Program the reporting code for all events to be transmitted. For description of when each reporting event will be transmitted, refer to Appendix A – Reporting Codes. The panel also supports Automatic SIA and Automatic Contact ID reporting. Program data [00] to disable the reporting of an event. If any other data is programmed (Data [01] to [FF]) the panel will automatically generate the correct reporting event when transmitting to the central station. For all formats excluding Automatic SIA and Automatic Contact ID, the panel will not attempt to report an event if data [00] or data [FF] is programmed for the reporting code.

Section [350] Communicator Format

Program the 2-digit number for the desired Communicator Format for the First Phone Number and Second Phone Number. When dialing the Third Phone Number, the system will use the Communicator Format programmed for Phone Number 1. Valid entries are [01] to [13]. Refer to the Programming Worksheet for a list of the available Communicator Formats. Refer to the *PC1616/PC1832/PC1864 Reference Manual* for Communicator Format details.

Section [351] to [376] Communicator Call Direction Options

Reporting events are categorized into 5 groups; Alarm/Restore, Opening/Closing, Tamper Alarm/Restore, System Maintenance and Test Transmissions. Program which Phone Number the control panel will use to transmit reporting events by turning the option ON in the correct Section. Phone Number 1 and/or Phone Number 2 can be used.

Section [377] Communicator Variables

Program a 3-digit number for each program entry:

Swinger Shutdown (Alarms): Maximum number of alarm/restoral transmissions per zone. Valid entries: [001] to [014]. Program data [000] to disable shutdown.

Swinger Shutdown (Tamper): Maximum number of tamper alarm/restoral transmissions per zone. Valid entries: [000] to [014]. Program data [000] to disable shutdown.

Swinger Shutdown (Trouble): Maximum number of trouble alarm/restoral transmissions per trouble condition. Valid entries: [000] to [014]. Program data [000] to disable shutdown.

Communicator (Transmission) Delay: Time, in seconds, panel will delay reporting an alarm event. Valid entries: [000] to [255].

AC Failure Communication Delay: Time, in minutes, panel will delay reporting an AC trouble event. Valid entries: [000] to [255].

TLM Trouble Delay: Time, in 3 second checks, before the system will consider the phone line disconnected. Valid entries: [002] to [255] (e.g., 3 x10 seconds = 30 seconds).

 TLM Restoral follows the same delay.

Test Transmission Cycle (Land Line): Number of days between test transmission reporting events. Valid entries: [001] to [255].

For Future Use

Wireless Zone Low Battery Delay: Number of days the system will delay reporting a wireless low battery to the central station. Valid entries: [000] to [255]. Program data [000] for no delay.

Delinquency Transmission Delay: Number of hours (Activity Delinquency) or days (Arming Delinquency) the panel will delay before transmitting the event to the central station. Valid entries: [001] to [255].

Communication Cancel Window: Time, in seconds, after an alarm has occurred that the system will report a Communication Cancel reporting event if the system is disarmed. They keypad will beep rapidly to indicate the Communication Cancel reporting event has been communicated successfully. Valid entries: [001] to [255].

Section [378] Test Transmission Time

Program the time the system will report a Test Transmission reporting event. Program 4 digits – [HH][MM] using military standard. For a test transmission at 11:00 pm, program data [23][00]. Valid entries are [00][00] to [23][59].

Section [379] Periodic DLS Time of Day

Programs the time the system will auto-call DLS. Program 4 digits – [HH][MM] using military standard. For a DLS auto-call at 11:00 pm, program data [23][00]. Valid entries are [00][00] to [23][59]. Programming [99][99] will select a random time, [FF][FF] will disable it. Please refer to the *PC 1616/1832/1864 Reference Manual* for a complete description of Periodic DLS.



Section [380] First Communicator Option Code

Option Description

- [1] **ON:** the system communicator is enabled. **OFF:** the communicator is disabled.
- [2] **ON:** the system transmits alarm restorals if the zone is restored and the bell has timed out. **OFF:** the system transmits alarm restorals immediately when the zone is restored.
- [3] **ON:** the panel uses rotary (pulse) dialing. **OFF:** the panel uses touchtone (DTMF) dialing
- [4] **ON:** the panel will switch from touchtone dialing to rotary dialing after the 4th failed attempt to communicate.
OFF: the panel will use DTMF dialing for all dialing attempts.
- [5] **ON:** the system uses the Third Phone Number to back up the First Phone Number. **OFF:** the Third Phone Number is disabled.
- [6] **ON:** the system alternates between the First Phone Number and Third Phone Number when attempting to report an event.
OFF: the panel will dial the First Phone Number for the programmed number of attempts, then switch to the Third Phone Number.
- [7] **For future Use**
- [8] **ON:** the Delinquency feature follows zone activity. **OFF:** the Delinquency feature follows arming.

Section [381] Second Communicator Option Code

Option Description

- [1] **ON:** the keypad beeps 8 times after successfully transmitting the **Opening After Alarm** reporting event. **OFF:** the keypad does not beep.
- [2] **ON:** the bell output squawks 8 times after successfully transmitting the **Opening After Alarm** reporting event. **OFF:** the bell output does not activate.
- [3] **ON:** the system uses programmed reporting codes when transmitting using the SIA format.
OFF: the system automatically generates all reporting codes transmitted.
- [4] **ON:** the system beeps the keypad 8 times after successfully transmitting a **Closing** reporting event. **OFF:** the keypad does not beep.
- [5] **ON:** the system requests a **Listen in/Two-way** session the next time it calls the **1st/3rd Phone Number** when the PC59xx transmits a request. **OFF:** the system ignores the request from the PC59xx.
 This Option is used with PC59xx series modules.
- [6] **ON:** the system requests a **Listen in/Two-way** session the next time it calls the **2nd Phone Number** when the PC59xx transmits a request.
OFF: the system will ignore the request from the PC59xx.
 This Option is used with PC59xx series modules.
- [7] **ON:** the system uses **Contact ID format** programmed reporting codes when transmitting reporting codes.
OFF: the system automatically generates all reporting codes transmitted.
- [8] **ON:** the system will follow ULC Communication Priority **OFF:** the system will follow standard communications priority.

Section [382] Third Communicator Option Code

Option Description

- [1] **ON:** the system will use the digit [5] as the first digit of the Partial Closing reporting code when transmitting Contact ID reporting codes.
OFF: the system will use the digit [4] as the first digit of the Partial Closing reporting code when transmitting Contact ID reporting codes.
- [2] **ON:** the system will transmit all alarms during Walk Test. **OFF:** the system will not report alarm events during Walk Test.

- [3] **ON:** the keypad will display the message ‘**Communications Cancelled**’ (programmable LCD) or ‘**CC**’ (fixed-message LCD) upon successful transmission of the Communication Cancelled reporting event. **OFF:** the keypad will not display these messages.
- [4] **ON:** the system dials the **Call Waiting Cancel String** on the first attempt to dial the central station. **OFF:** the system does not dial the Call Waiting Cancel String.
- [5] **ON:** enables support for the T-Link module. **OFF:** disables T-Link.
- [6] **ON:** the **AC Failure Transmission Delay Timer** will use hours. **OFF:** the delay will be in minutes.
- [7] **ON:** Sets the number of Dialing attempts to 1 when using Residential Dial Format. **OFF:** Residential Dial follows Dialing Attempt Counter.
- [8] **For Future Use**

Section [383] Fourth Communicator Option Code

Option	Description
--------	-------------

- | | |
|-------|--|
| [1] | ON: Events programmed to communicate to phone #1 will use the Partition Account Number in section [311]. Events Programmed to communicate to phone #2 will use the Partition Account Number in section [312]. OFF: Each events will use its respective partition account code. |
| [2-8] | For Future Use |

Section [389] T-Link Fault Check Timer

Program the period of time (in seconds) in between checks to see if the T-Link module is present. Valid entries are [001]-[255].

Section [401] First Downloading Option Code

Option	Description
--------	-------------

- | | |
|---------|--|
| [1] | ON: the system answers incoming calls for downloading (either Programmed Number of Rings or Double Call). OFF: the system does not answer incoming calls using the double call routine for downloading.

 These settings do not affect the 6 hour DLS downloading window on power up. |
| [2] | ON: the user can enable downloading for the DLS Window using the [*][6] command. OFF: the user cannot enable downloading. |
| [3] | ON: the system will hang up after a successful DLS connection and call the computer back using the DLS Phone Number (Section [402]). OFF: the system stays connected to the computer. |
| [4] | ON: the user can initiate a downloading session using the [*][6] command. OFF: the user cannot initiate a downloading session. |
| [5] | ON: the system attempts to call the downloading computer after transmitting a Event Buffer 75% Full event to the central station. OFF: the system does NOT call the downloading computer after transmitting this event. |
| [6] | ON: Panel communicates with DLS at 300 Baud. OFF: Panel communicates with DLS at 110 Baud. |
| [7]-[8] | For Future Use |

Section [402] Downloading Computer Phone Number

The Downloading Computer Telephone Number is used for Call Back, User Initiated DLS and the Auto Event Buffer Upload functions. Program the phone number as required. HEX digits can be included for special applications:

HEX [A]	Not used
HEX [B]	Simulates a [*] key press
HEX [C]	Simulates a [#] key press
HEX [D]	Additional dial tone search
HEX [E]	2-second pause
HEX [F]	End of phone number marker

Section [403] Downloading Access Code

Program the 6-digit Downloading Access Code. Upon connection, the system will only connect to the downloading computer if the Downloading Access Code programmed matches the Downloading Access Code programmed in the computer file.

Section [404] Panel Identification Code

Program the 6-digit Panel Identification Code. This code is used by the downloading computer to verify the correct account is calling back (Call Back feature) or to identify which customer account file should be used (User Initiated DLS and Auto Event Buffer Upload features).

Section [405] Double-Call Timer

Program the maximum time, in seconds, between calls when connecting to panel using the double call feature. Valid entries are [000] to [255].

Section [406] Number of Rings to Answer On

Program the number of consecutive rings that panel must detect to answer for downloading. Valid entries are [000] to [010].

Section [499] PC-Link Communications

Enter the following command to initiate downloading via PC-Link – Section [499] [Installer Code] [499]. Plugging in the PC-Link connector will automatically initiate the connection if DLS is initiated before connecting the PC-Link Header. The session will NOT be automatically initiated if the system is in installer mode.

Section [501] to [514] Programmable Output Attributes

These Sections are used to customize the operation of the PGM outputs (Section [501] for PGM 1, Section [502] for PGM 2 etc.). The available options depend on which PGM output type is programmed.

When the PGM Output Options (Section [009] to [011]) are programmed, the system will change the PGM Attributes to the default settings. The PGM Attributes will default if a new PGM output option is programmed.

PGM Output Option [01], [03] to [08], [11] to [22], [25],[26], [28], [30], [33], [34]

Option Description

- [3] **ON:** the PGM output will operate normally (switch to ground when activated). **OFF:** the PGM output will be normally ground and switch to open collector (open circuit) when activated.

PGM Output Option [19] to [22]

Option Description

- [4] **ON:** the PGM output will activate for the duration of the PGM Output Timer when the [*][7][x] command is performed. **OFF:** the PGM output will latch until the [*][7][x] command is performed again.
- [5] **ON:** a valid user code must be entered after the [*][7][x] command. **OFF:** user code is not required.

PGM Output Option [09]

Option Description

- [1] **ON:** PGM output activates if a Service Required trouble condition is present.
- [2] **ON:** PGM output activates if an AC trouble condition is present.
- [3] **ON:** PGM output activates if a Telephone Line trouble condition is present.
- [4] **ON:** PGM output activates if a Failure to Communicate trouble condition is present.
- [5] **ON:** PGM output activates if a Zone Fault condition is present.
- [6] **ON:** PGM output activates if a Zone Tamper condition is present.
- [7] **ON:** PGM output will activates if a Wireless Low Battery trouble condition is present.
- [8] **ON:** PGM output will activates if a Loss of Clock trouble condition is present.

PGM Output Option [10]

Option Description

- [1] **ON:** PGM output activates if a Burglary Alarm occurs.
- [2] **ON:** PGM output activates if a Fire Alarm occurs.

- [3] **ON:** PGM output activates if a Panic Alarm occurs.
- [4] **ON:** PGM output activates if a Medical Alarm occurs.
- [5] **ON:** PGM output activates if a Supervisory Alarm occurs.
- [6] **ON:** PGM output activates if a Priority Alarm occurs.
- [7] **ON:** PGM output will activates if a 24-Hour Hold-Up Alarm occurs.
- [8] **ON:** the PGM output activates for the time programmed for the PGM Output Timer. **OFF:** the PGM output will latch until a valid user code is entered.

PGM Output Option [31]

Option Description

- [1] **ON:** PGM output activates if a Fire Alarm occurs.
- [2] **ON:** PGM output activates if a Panic Alarm occurs.
- [3] **ON:** PGM output activates if a Burglary Alarm occurs.
- [4] **ON:** PGM output activates if an Opening/Closing occurs.
- [5] **ON:** PGM output activates if a a zone is automatically bypassed.
- [6] **ON:** PGM output activates if a Medical Alarm occurs.
- [7] **ON:** PGM output will activates if a confirmed alarms occurs and Police Code occurs.
- [8] **ON:** the PGM output is active when the selected condition is true. **OFF:** the PGM output will latch until a valid user code is entered

PGM Output Option [32]

Option Description

- [1]-[7] For Future Use
- [8] **ON:** the PGM will activate for the duration programmed in PGM Output Timer. **OFF:** the PGM will activate when an Opening After Alarm occurs and will deactivate when a valid access code is entered.

PGM Output Option [29] and [35]-[41]

Option Description

- [1]-[2] For Future Use
- [3] **ON:** the PGM will switch to ground when the event occurs. **OFF:** the PGM will switch to open when the event occurs.
- [4]-[7] For Future Use
- [8] **ON:** AND logic is selected, all zones that are enabled must be violated before the PGM will activate. **OFF:** OR Logic is selected, only one violated zone is required to activate the PGM. All zones must be restored to turn it OFF.

 Zones are assigned to this PGM in the PGM Partition Assignment Section [551]-[564]

Section [551] to [564] PGM Partition Assignment

These sections are used to customize the operation of the PGM outputs (Section [551] for PGM 1, Section [552] for PGM 2 etc.). Turn on the correct option in the correct section to assign the PGM output to a specified partition. PGM outputs can be assigned to more than one partition. For PGM outputs that are considered ‘system’ outputs (e.g., Trouble output), programming in these sections will not affect the operation of the PGM output. For Zone Follower PGM types 29, 35-41 these sections are used to assign specific zones to the PGM.

 Any one Command Output PGM type cannot be assigned to more then one partition.

Section [601] to [608] Additional Reporting Codes

Program the reporting code for all events to be transmitted. For description of when each reporting event will be transmitted, refer to Appendix A – Reporting Codes. The panel also supports Automatic SIA and Automatic Contact ID reporting. Program data [00] to disable the reporting of an event. If any other data is programmed (Data [01] to [FF]) the panel will automatically generate the correct reporting event when transmitting to the central station. For all formats excluding Automatic SIA and Automatic Contact ID, the panel will not attempt to report an event if data [00] or data [FF] is programmed for the reporting code.

Section [681] to [688] Auto-Disarm Schedules

Program the time to auto-disarm (Section [681] for Partition 1, Section [682] for Partition 2 etc.) for each day of the week. Each Section has seven, 4-digit entries, two digits for the hour, two digits for the minute, for Sunday through Saturday. Program using the military format (for example, to auto arm at 8:00 pm program data [20][00]). Valid entries are [00][00] to [23][59] – program [99][99] to disable auto disarming

Section [691] to [698] Auto-Disarm Holiday Schedule

Program the dates to be used for Auto-Disarm holiday schedule (Section [691] for Partition 1, Section [692] for Partition 2 etc.) Each Section has fourteen, 6-digit entries, two digits for the month, two digits for the day and two digits for the year. The panel will not disarm on the programmed dates. The format of entering the date is MMDDYY. Program [99][99][99] to disable Auto-Disarm holiday schedule.

Section [700] Automatic Clock Adjust

Program the number of seconds for the last minute of the day. This can be used to make minor corrections to the clock if the AC frequency is not reliable. Valid entries are [01] to [99].

Section [701] First International Option Code

Option	Description
--------	-------------

- | | |
|-----|---|
| [1] | ON: configures the system for 50Hz AC. OFF: configures the system for 60Hz AC. |
| [2] | ON: the system uses the internal crystal for the internal panel clock. OFF: the system uses the AC frequency for the internal panel clock. |
| [3] | ON: the system will inhibit arming if a Low Battery or AC trouble condition is present. OFF: arming will not be inhibited. |
| [4] | ON: all Tamper troubles will latch and arming will be inhibited. Enter Installer Programming to clear the trouble condition and return to normal operation. OFF: tamper troubles will not latch and will not inhibit arming. |
| [5] | ON: all access codes are 6 digits long. OFF: all access codes are 4 digits long. |
| [6] | ON: the system will hang up if a busy tone is detected. This attempt is not counted towards the Maximum Dialing Attempts programmed. OFF: the panel will not detect busy tones. |
| [7] | ON: the system will charge the battery at approximately 700mA. OFF: the system will charge the battery at 400mA. |
| [8] | ON: the system will abort a DLS session, Escort access, Listen In/Two-way session if a new central station communication event occurs. OFF: non-critical events (Test transmission, Periodic Test and System Test) will not abort the session. Events will be communicated after the session is complete. |

Section [702] Second International Option Code

Option	Description
--------	-------------

- | | |
|-----|---|
| [1] | ON: the communicator uses 33/67 make/break ratio when pulse dialing. OFF: the system uses 40/60 make/break ratio. |
| [2] | ON: the system dials regardless of the presence of dial tone after the first attempt. OFF: the system dials only if dial tone is detected. |
| [3] | ON: changes the Test Transmission Cycle Time to minutes. OFF: sends a Test Transmission after the programmed number of days. |
| [4] | ON: the system accepts 1600Hz handshake pulse formats. OFF: the system accepts 1400Hz or 2300Hz handshakes. |
| [5] | ON: the system generates a tone for 500mS every 2 seconds indicating digital equipment is making the call vs. a voice call. OFF: the system does not generate a tone. |
| [6] | ON: the tone generated (2100Hz.) indicates that digital equipment is making the call. OFF: the tone is 1300Hz. |
| [7] | ON: the DLS down loading window is 1 hour. OFF: the DLS downloading window is 6 hours. |
| [8] | ON: the system activates the bell output if a Failure to Communicate trouble occurs while the system is armed. OFF: the system does NOT activate the bell output if a Failure to Communicate trouble occurs while the system is armed. |

Section [703] Delay Between Dialing Attempts

Program the time the panel will wait between dialing attempts to transmit a reporting event to the central station. Valid entries are [001] to [255].

Section [800]-[851] Module Programming

The following program sections are used to program different modules that can be connected to the control panel. Refer to the respective Installation Manual for installation and programming information

Section [801]:	PC5400 Printer Module Programming
Section [802]:	PC59xx VOX Module Programming
Section [803]:	Alternate Communicator Programming
Section [804]:	Wireless Programming
Section [805]:	PC5100 Addressable Programming
Section [851]:	T-Link Programming

Special Installer Instructions

Section [899] Template Programming

Selecting [*][8] [Installer Code] [899] displays the current 5 digit template programming code. Refer to Section 3.1 Template Programming on page 8 for details. Refer to Appendix C - Template Programming for a detailed description of available templates and corresponding 5 digit codes.

 This feature requires a PK55xx or RFK55xx series keypad, v.1.1 or higher.

Section [900]: Panel Version Displayed

Only available with LCD5500 or PK5500 keypads. The system will display the version of the control panel (for example, [0410] indicates panel version 4.10).

Section [901]: Installer Walk Test

The system will turn Installer Walk Test **ON**. The Ready, Armed and Trouble LED's will flash rapidly while the test is active. Every time a zone is violated the system will activate the bell output for two seconds and log the event to the event buffer. To turn Installer Walk Test **OFF** enter Section [901] again. The system automatically terminates the test if there is no zone activity for 15 minutes.

Section [902]: Module Supervision Reset

All modules are automatically detected within one minute after being connected to the Keybus. Enter Section [902] to clear detected modules if a module is removed, if PC5108 jumpers are changed, or if a keypad slot assignments are programmed. The system will rescan the Keybus to determine which modules are connected.

Section [903]: View Module Supervision

The keypad will display the modules detected by the system by turning on the associated zone light (LED keypads), flashing the numbers (fixed-message LCD keypads) or displaying the modules detected in plain language (programmable LCD keypads). Refer to the chart below:

Indicator Light (Zone)	Module
[01] to [08]	Keypad in Slot #1 to #8
[09] to [14]	PC5108 Zone Expander #1 to #6
[15]	PC5100 Module
[16]	PC5108 Zone Expander #7
[17]	PC5132 Module or RFK keypad with integrated wireless receiver
[18]	PC5208
[19]	PC5204 Module
[20]	PC5400 Module
[21]	PC59xx Module
[22]	Alternate Communicator
[24]	Escort5580 or Escort5580TC
[26] to [29]	PC5200 #1 to #4

Section [904]: Wireless Placement Test

Enter Section [904] followed by the 2-digit number of the wireless zone to test. When a wireless signal is received from the selected transmitter, the system will indicate the location as **Good** or **Bad** as follows:

Good: One bell squawk, 1 keypad beep, keypad zone light [1] ON

Bad: Three bell squawks, 3 keypad beeps, keypad zone light [3] ON

Press [#] to exit when testing is complete. Enter the 2-digit zone number for the next wireless device to test or press [#] to return to standard programming.

Section [990]: Installer Lockout Enable

Enter Section [990][Installer Code][990] to enable the Installer Lockout feature. A hardware default cannot be performed when the Installer Lockout feature is ON. In addition, the system will chatter the line seizure relay 10 times if the panel is powered up to indicate the feature is ON.

Section [991]: Installer Lockout Disable

Enter Section [991][Installer Code][991] to turn the Installer Lockout feature OFF.

Section [993] to [999]: Factory Default Module/Panel

The following Sections can be used to factory default a module or the main control panel. Enter the appropriate Section, followed by the Installer Code, followed by the Section number (E.g., [993][Installer Code][993])

Section [993]: Factory Default Alternate Communicator

Section [995]: Factory Default Escort5580 Module

Section [996]: Factory Default Wireless Receiver

Section [997]: Factory Default PC5400 Module

Section [998]: Factory Default PC59xx Module

Section [999]: Factory Default Main Control Panel

Hardware Reset (Default) Main Control Panel

Perform the following to default the main control panel:

1. Power down the system completely.
2. Connect a short between Zone 1 and PGM1 on the control panel (remove all other wires from these terminals).
3. Power up the control panel (AC power only) for 10 full seconds.
4. Power down the control panel, remove short between Zone 1 and PGM1.
5. Power up the control panel.

Section 5: Programming Work Sheets

5.1 Index to Programming Work Sheets

Programming Option	Page	Programming Option	Page
[000] Keypad Enrollment	28	[348] Test Transmission Reporting Codes	42
[001]-[004] Zone Definitions	28	[349] PC5700 Maintenance Reporting Codes	42
[005] System Times	29	[350] Communicator Format Options	43
[006] Installer's Code	30	[351]-[358] Alarm/Restore Communicator Call Directions	43
[007] Master Code	30	[359]-[366] Tamper/Restore Communicator Call Directions	43
[008] Maintenance Code	30	[367]-[374] Opening/Closing Communicator Call Directions	43
[009] PGM 1&2 Output Programming (Main Panel)	30	[375] System Maintenance Communicator Call Directions	44
[010] PGM 3-10 Output Programming (Main Panel/PC5208)	30	[376] System Test Transmissions Communicator Call Directions	44
[011] PGM 11-14 Output Programming (PC5204)	30	[377] Communication Variables	44
[012] Keypad Lockout Options	30	[378] Test Transmission Time of Day	44
[013] 1st System Options	31	[379] Periodic DLS Time of Day	44
[014] 2nd System Options	31	[380] 1st Communicator Options	44
[015] 3rd System Options	31	[381] 2nd Communicator Options	45
[016] 4th System Options	31	[382] 3rd Communicator Options	45
[017] 5th System Options	32	[383] 4th Communicator Options	45
[018] 6th System Options	32	[401] DLS Downloading Option Codes	45
[019] 7th System Options	32	[402] DLS Downloading Telephone Number (32 Digits)	46
[020] Keypad Zone Assignments	32	[403]-[404] DLS Downloading Access Code / Panel ID Code	46
[021] 8th System Options	33	[405] Answering Machine Double Call Timer	46
[022] 9th System Options	33	[406] Number of Rings to Answer On	46
[023] 10th System Options	33	[499] Initiate PC-Link Downloading	46
[030] Zone Loop Response (Zones 1-8)	33	[501]-[502] PGM 1&2 Output Attributes (Main Panel)	47
[101] - [164] Zone Attributes	34	[503]-[504] PGM 3&4 Output Attributes (Main Panel / PC5208)	47
[165] Maximum Dialing Attempts to Each Telephone Number	36	[505]-[510] PGM 5-10 Output Attributes (5208)	47
[166] Post Dial Wait for Handshake (All Formats)	36	[511]-[515] PGM 11-14 Output Attributes (5204)	47
[167] T-LINK Interface Communications Wait for Acknowledge	37	[551]-[552] PGM 1&2 Output Partition Assignment (Main Panel)	48
[168] Set Clock Forward (Daylight Saving Time)	37	[553]-[554] PGM 3&4 Output Partition Assignment (Main Panel/PC5208)	48
[169] Set Clock Back (Standard Time)	37	[555]-[560] PGM 5-10 Output Partition Assignment (5208)	48
[170] PGM Output Timer	37	[561]-[564] PGM 11-14 Output Partition Assignment (5204)	48
[175] Auto-arm Postpone Timer	37	[601]-[604] Closing (Arming) Reporting Codes	48
[176] Cross Zone/Police Code Timer	37	[605]-[608] Opening (Disarming) Reporting Codes	49
[181]-[188] Automatic Arming Schedule	37	[681]-[688] Automatic Disarming Schedule	49
[190] No Activity Arming Pre-Alert Time	37	[691]-[698] Auto-Disarm Holiday Schedule	49
[191]-[198] No Activity Arming Timers	38	[700] Automatic Clock Adjust	50
[199] Auto-arming Pre-Alert Timer	38	[701] 1st International Options	50
[201] Partition Selection Mask	38	[702] 2nd International Options	50
[301] 1st Telephone Number (32 Digits)	39	[703] Delay between Dialing Attempts	50
[302] 2nd Telephone Number (32 Digits)	39	[801] PC5400 Printer Module Programming	51
[303] 3rd Telephone Number (32 Digits)	39	[802] PC59xx VOX Programming	51
[304] Call Waiting Cancel String (6 Digits)	39	[804] PC5132 Wireless Expansion Programming	51
[310] System Account Code	39	[805] PC5100 Programming	51
[311]-[318] Partition 1-8 Account Numbers	39	[851] T-LINK Programming	51
[320]-[323] Alarm Reporting Codes, Zones 01-64	39	[899] Template Programming	51
[324]-[327] Alarm Restoral Reporting Codes, Zones 01-64	40	[900] Panel Version Displayed	51
[328] Miscellaneous Alarm Reporting Codes	40	[901] Installer Walk Test Mode Enable/Disable	51
[329] Priority Alarm and Restoral	40	[902] Module Supervision Reset	51
[330]-[333] Tamper Reporting Codes, Zones 01-64	40	[903] Module Supervision Field	51
[334]-[337] Tamper Restoral Reporting Codes, Zones 01-64	41	[904] Wireless Module Placement Test	51
[338] Miscellaneous Tamper Reporting Codes	41	[990] Installer Lockout Enable	51
[339]-[340] Closing (Arming) Reporting Codes, Access Codes 1-32	41	[991] Installer Lockout Disable	51
[341] Miscellaneous Closing (Arming) Reporting Codes	41	[993] Restore Alternate Communicator to Default Programming	51
[342]-[343] Opening (Disarming) Reporting Codes, Access Codes 1-32	41	[995] Restore Escort5580 to Default Programming	51
[344] Miscellaneous Opening (Disarming) Reporting Codes	42	[996] Restore PC5132 to Default Programming	51
[345] Maintenance Alarm Reporting Codes	42	[997] Restore PC5400 to Default Programming	51
[346] Maintenance Restoral Reporting Codes	42	[998] Restore PC59xx to Default Programming	51
[347] Miscellaneous Maintenance Reporting Codes	42	[999] Restore Control Panel to Default Programming	51

5.2 Programming Worksheets

i Shaded programming sections indicate minimum programming requirements

i SIA FAR CP-01 defaults are indicated in gray text.

Keypad Partition /Slot and Function Key Programming

[000] Keypad Enrollment

i This must be done at each keypad requiring programming.

[0] Slot address [Valid entries are 0-8 for the partition, 1-8 for the slot. (e.g., to enroll a keypad in partition 3 and slot 1, enter (31))]

[1] Function Key 1 Assignment (Valid entries are 00-33)

[2] Function Key 2 Assignment (Valid entries are 00-33)

[3] Function Key 3 Assignment (Valid entries are 00-33)

[4] Function Key 4 Assignment (Valid entries are 00-33)

[5] Function Key 5 Assignment (Valid entries are 00-33)

Function Key Options:

- | | | |
|-----------------------------|---|------------------------|
| 00 Not used | 11 [*][5] Access Code Programming | 22 Global Disarming |
| 01 Select Partition 1 | 12 [*][6] User Functions | 23 Bypass Recall |
| 02 Select Partition 2 | 13 Command Output #1 [*][7][1] | 24 Recall Bypass Group |
| 03 Stay Arm | 14 Command Output #2 [*][7][2]/Sensor Reset | 25 For Future Use |
| 04 Away Arm | 15 Global Stay Arming | 26 Time and Date |
| 05 [*][9] No-Entry Arm | 16 [*][0] Quick Exit | 27 Select Partition 3 |
| 06 [*][4] Chime On / Off | 17 [*][1] Reactivate Stay/Away Zones | 28 Select Partition 4 |
| 07 [*][6][—][4] System Test | 18 Global Away Arming | 29 Select Partition 5 |
| 08 [*][1] Bypass Mode | 19 Command Output 3 [*][7][3] | 30 Select Partition 6 |
| 09 [*][2] Trouble Display | 20 For Future Use | 31 Select Partition 7 |
| 10 [*][3] Alarm Memory | 21 Command Output 4 [*][7][4] | 32 Select Partition 8 |
| | | 33 Activate Local PGM |

	Partition/ Slot	[20] Zone Assigned	Key 1	Key 2	Key 3	Key 4	Key 5
ICON / LED Defaults	11	00	03	04	06	14	16
Full Message Defaults	18	00	03	04	06	14	16
KEYPAD 1		00					
KEYPAD 2		00					
KEYPAD 3		00					
KEYPAD 4		00					
KEYPAD 5		00					
KEYPAD 6		00					
KEYPAD 7		00					
KEYPAD 8		00					

[001]-[004] Zone Definitions

- | | | |
|---------------------------------------|------------------------------|---|
| 00 Null Zone (Not Used) | 12 24 Hour Holdup* | 25 Interior Delay* |
| 01 Delay 1* | 13 24 Hour Gas* | 26 24 Hour Non-alarm* |
| 02 Delay 2* | 14 24 Hour Heating* | 29 Auto Verified Fire |
| 03 Instant* | 15 24 Hour Auxiliary* | 30 Fire Supervisory |
| 04 Interior* | 16 24 Hour Panic* | 31 Day Zone* |
| 05 Interior, Stay/Away* | 17 24 Hour Emergency* | 32 Instant Stay/Away* |
| 06 Delay, Stay/Away* | 18 24 Hour Sprinkler* | 35 24-hour Bell/Buzzer |
| 07 Delayed 24 Hour Fire (Hardwired)** | 19 24 Hour Water* | 36 24 Hour Non-Latching Tamper Zone |
| 08 Standard 24 Hour Fire (Hardwired) | 20 24 Hour Freeze* | 37 Night Zone |
| 09 24 Hour Supervisory | 21 24 Hour Latching Tamper* | 87 Delay 24 Hour Fire (Wireless/Addressable)** |
| 10 24 Hour Supervisory Buzzer* | 22 Momentary Keyswitch Arm* | 88 Standard 24 Hour Fire (Wireless/Addressable)** |
| 11 24 Hour Burglary* | 23 Maintained Keyswitch Arm* | |
- *For burglary applications only ** For residential fire applications only

Section	Zone	Def.		Section	Zone	Def.		Section	Zone	Def.		Section	Zone	Def.	
[001]	01	01	_ _	[002]	17	00	_ _	[003]	33	00	_ _	[004]	49	00	_ _
	02	03	_ _		18	00	_ _		34	00	_ _		50	00	_ _
	03	03	_ _		19	00	_ _		35	00	_ _		51	00	_ _
	04	03	_ _		20	00	_ _		36	00	_ _		52	00	_ _
	05	04	_ _		21	00	_ _		37	00	_ _		53	00	_ _
	06	04	_ _		22	00	_ _		38	00	_ _		54	00	_ _
	07	04	_ _		23	00	_ _		39	00	_ _		55	00	_ _
	08	04	_ _		24	00	_ _		40	00	_ _		56	00	_ _
	09	00	_ _		25	00	_ _		41	00	_ _		57	00	_ _
	10	00	_ _		26	00	_ _		42	00	_ _		58	00	_ _
	11	00	_ _		27	00	_ _		43	00	_ _		59	00	_ _
	12	00	_ _		28	00	_ _		44	00	_ _		60	00	_ _
	13	00	_ _		29	00	_ _		45	00	_ _		61	00	_ _
	14	00	_ _		30	00	_ _		46	00	_ _		62	00	_ _
	15	00	_ _		31	00	_ _		47	00	_ _		63	00	_ _
	16	00	_ _		32	00	_ _		48	00	_ _		64	00	_ _

[005] System Times

Valid entries for Entry Delay is between 030-255, valid entries for Exit Delay is between 045-255 for SIA CP-01.

[01] Partition 1 Entry/Exit times

030 |_|_|_| Entry Delay 1
 045 |_0_|_3_|_0_| Entry Delay 2
 120 |_0_|_6_|_0_| Exit Delay

[02] Partition 2 Entry/Exit times

030 |_|_|_| Entry Delay 1
 045 |_0_|_3_|_0_| Entry Delay 2
 120 |_0_|_6_|_0_| Exit Delay

[03] Partition 3 Entry/Exit times

030 |_|_|_| Entry Delay 1
 045 |_0_|_3_|_0_| Entry Delay 2
 120 |_0_|_6_|_0_| Exit Delay

[04] Partition 4 Entry/Exit times

030 |_|_|_| Entry Delay 1
 045 |_0_|_3_|_0_| Entry Delay 2
 120 |_0_|_6_|_0_| Exit Delay

[09] Bell Cut-Off Timer (All Partitions)

004 |_|_|_| Enter 3 digits from 001-255

[05] Partition 5 Entry/Exit times

030 |_|_|_| Entry Delay 1
 045 |_0_|_3_|_0_| Entry Delay 2
 120 |_0_|_6_|_0_| Exit Delay

[06] Partition 6 Entry/Exit times

030 |_|_|_| Entry Delay 1
 045 |_0_|_3_|_0_| Entry Delay 2
 120 |_0_|_6_|_0_| Exit Delay

[07] Partition 7 Entry/Exit times

030 |_|_|_| Entry Delay 1
 045 |_0_|_3_|_0_| Entry Delay 2
 120 |_0_|_6_|_0_| Exit Delay

[08] Partition 8 Entry/Exit times

030 |_|_|_| Entry Delay 1
 045 |_0_|_3_|_0_| Entry Delay 2
 120 |_0_|_6_|_0_| Exit Delay

i For SIA CP-01 compliant installations, the Exit Delay must be within the range of 045-255 seconds (Default 60 seconds). If the Exit Delay is silent (Section 14, Option 6 or Stay Function Key Arming) the exit delay must be twice the programmed value but must not exceed 255 seconds (i.e., 090-255 seconds).

i For UL Installations, the Entry Delay plus the Communications Delay must not exceed 60 seconds.

i Exit Time Restart shall be disabled when the panel is used in combination with T-Link TL250/TL300.

[006] Installer's Code Default 5555 <input type="text"/>	[007] Master Code Default 1234 <input type="text"/>	[008] Maintenance Code Default AAAA <input type="text"/>
---	--	---

Programmable Output Options

01 Residential Burglary and Fire Bell Output	18 Stay Armed Status	36 Zone Follower Output (Zones 17-24)
02 For Future Use	19 Command Output #1 ([*][7][1])	37 Zone Follower Output (Zones 25-32)
03 Sensor Reset [*][7][2]	20 Command Output #2 ([*][7][2])	38 Zone Follower Output (Zones 33-40)
04 2 Wire Smoke Support (PGM 2 only)	21 Command Output #3 ([*][7][3])	39 Zone Follower Output (Zones 41-48)
05 System Armed Status	22 Command Output #4 ([*][7][4])	40 Zone Follower Output (Zones 49-56)
06 Ready To Arm	23 24 Hour Silent Input	41 Zone Follower Output (Zones 57-64)
07 Keypad Buzzer Follow Mode	24 24 Hour Audible Input	
08 Courtesy Pulse	25 Delayed Fire and Burglary Output	
09 System Trouble Output (with Trouble options)	26 Battery Test Output	
10 System Event [Strobe (with Event options)]	28 Holdup Output	
11 System Tamper (all sources: zones, keypad, modules)	29 Zone Follower Output (Zones 1-8)	
12 TLM and Alarm	30 Partition Status Alarm Memory	
13 Kissoff Output	31 Alternate Communicator	
14 Ground Start Pulse	32 Open After Alarm	
15 Remote Operation (DLS-3 Support)	33 Bell Status and Programming Access Output	
16 For Future Use	34 Away Armed with no Zone Bypassed Status	
17 Away Armed Status	35 Zone Follower Output (Zones 9-16)	

Output types [03] and [20] cannot be used together on the same system.

[009] PGM1 and PGM2 Output Programming (Main Panel)

1 Program PGM Option Attributes in sections [501] - [514]. Program PGM partitions in sections [551] - [564]

1 PC1616 and PC1832 have 2 onboard PGMs (PGM 1 and 2). PC1864 has 4 onboard PGMs (PGM 1-4)

Default 19 <input type="text"/> PGM 1	Default 10 <input type="text"/> PGM 2
---	---

[010] PGM3 to PGM10 Output Programming (Main Panel/PC5208)

1 Program PGM Option Attributes in sections [501] - [514]. Program PGM partitions in sections [551] - [564]

Default 01 <input type="text"/> PGM 3 (main panel/PC5208)*	Default 01 <input type="text"/> PGM 7 (PC5208)
01 <input type="text"/> PGM 4 (main panel/PC5208)*	01 <input type="text"/> PGM 8 (PC5208)
01 <input type="text"/> PGM 5 (PC5208)	01 <input type="text"/> PGM 9 (PC5208)
01 <input type="text"/> PGM 6 (PC5208)	01 <input type="text"/> PGM 10 (PC5208)

These two sections allow you to program both PGM3 and PGM4 on the main panel, and the first two PGM outputs on the PC5208. If you use both the main panel and the PC5208 outputs, PGM3 will work the same as the first PC5208 output, and PGM4 will work the same as the second PC5208 output.

[011] PGM 11 to PGM 14 Output Programming (PC5204)

1 Program PGM Option Attributes in sections [501] - [514]. Program PGM partitions in sections [551] - [564]

Default 01 <input type="text"/> PGM 11	Default 01 <input type="text"/> PGM 13
01 <input type="text"/> PGM 12	01 <input type="text"/> PGM 14

Other System Options

[012] Keypad Lockout Options

1 If Keypad Lockout is active, the panel cannot be disarmed with a keyswitch.

Default

000 <input type="text"/>	Number of Invalid Codes Before Lockout (001-255 codes)
000 <input type="text"/>	Lockout Duration (001-255 minutes)

[013] First System Options

Opt	Def	ON	OFF
1	<input type="checkbox"/>	Normally Closed Loops	✓ <input type="checkbox"/> End-of-line Resistors
2	<input type="checkbox"/>	Double End-of-line Resistors	✓ <input type="checkbox"/> Single End-of-line Resistors
3	✓ <input type="checkbox"/>	Panel shows all Troubles when armed	<input type="checkbox"/> Panel shows only Fire Troubles when armed
4	<input type="checkbox"/>	Tampers/Faults do not show as open	✓ <input type="checkbox"/> Tampers/Faults show as open
5	✓ <input type="checkbox"/>	Auto Arm Schedule in [*][6] and installers	<input type="checkbox"/> Auto-arm Schedule in Installer Programming Only
6	✓ <input type="checkbox"/>	Audible Exit Fault Enabled	<input type="checkbox"/> Audible Exit Fault Disabled
7	✓ <input type="checkbox"/>	Event Buffer Follows Swinger Shutdown	<input type="checkbox"/> Event Buffer Logs Events past Shutdown
8	<input type="checkbox"/>	Temporal Three Fire Signal Enabled	✓ <input type="checkbox"/> Standard Pulsed Fire Signal

[014] Second System Options

Opt	Def	ON	OFF
1	<input type="checkbox"/>	Arm /Disarm Bell Squawk Enabled	✓ <input type="checkbox"/> Arm /Disarm Bell Squawk Disabled
2	<input type="checkbox"/>	Bell Squawk During Auto-arm	✓ <input type="checkbox"/> No Bell Squawk During Auto-arm
3	<input type="checkbox"/>	Bell Squawk On Exit Delay	✓ <input type="checkbox"/> No Bell Squawk On Exit Delay
4	<input type="checkbox"/>	Bell Squawk On Entry Delay	✓ <input type="checkbox"/> No Bell Squawk On Entry Delay
5	<input type="checkbox"/>	Bell Squawk On Trouble	✓ <input type="checkbox"/> No Bell Squawk On Trouble
6	✓ <input type="checkbox"/>	Audible Exit with Urgency	<input type="checkbox"/> Silent Exit Delay
7	<input type="checkbox"/>	Exit Delay Termination Enabled	✓ <input type="checkbox"/> Exit Delay Termination Disabled
8	<input type="checkbox"/>	Residential Fire Bell is Continuous	✓ <input type="checkbox"/> Residential Fire Bell is Cut-off

[015] Third System Options

Opt	Def	ON	OFF
1	✓ <input type="checkbox"/>	Fire Key Enabled	<input type="checkbox"/> Fire Key Disabled
2	<input type="checkbox"/>	Panic Key Audible (Bell / Beeps)	✓ <input type="checkbox"/> Panic Key Silent
3	<input type="checkbox"/>	Quick Exit Enabled (ON for SIA CP-01)	✓ <input type="checkbox"/> Quick Exit Disabled
4	✓ <input type="checkbox"/>	Quick Arming Enabled (No Code Required)	<input type="checkbox"/> Quick Arming Disabled (Code Required)
5	<input type="checkbox"/>	Code Required for Bypassing	✓ <input type="checkbox"/> NO Code Required for Bypassing
6	<input type="checkbox"/>	Master Code NOT Changeable (ON for SIA CP-01)	✓ <input type="checkbox"/> Master Code Changeable
7	✓ <input type="checkbox"/>	TLM Enabled	<input type="checkbox"/> TLM Disabled
8	<input type="checkbox"/>	TLM Audible (Bell) when Armed	✓ <input type="checkbox"/> TLM Trouble Beeps when Armed

[016] Fourth System Options

Opt	Def	ON	OFF
1	✓ <input type="checkbox"/>	AC Trouble Displayed	<input type="checkbox"/> AC Trouble NOT Displayed
2	<input type="checkbox"/>	Trouble Light Flashes if AC Fails	✓ <input type="checkbox"/> Trouble Light does NOT follow AC Status
3	<input type="checkbox"/>	Blank Keypad when Not Used	✓ <input type="checkbox"/> Keypad Blanking Disabled
4	<input type="checkbox"/>	Code required to remove Keypad Blanking	✓ <input type="checkbox"/> No Code Required
5	✓ <input type="checkbox"/>	Keypad Backlighting is Enabled	<input type="checkbox"/> Keypad Backlighting is Disabled
6	<input type="checkbox"/>	Power Save Mode Enabled	✓ <input type="checkbox"/> Power Save Mode Disabled
7	<input type="checkbox"/>	Bypass Status Displayed While Armed	✓ <input type="checkbox"/> Bypass Status NOT Displayed While Armed
8	<input type="checkbox"/>	Keypad Tampers Enabled	✓ <input type="checkbox"/> Keypad Tampers Disabled

[017] Fifth System Options

Opt	Def	ON	OFF
1	✓	<input type="checkbox"/> WLS Key Does NOT use Access Codes	<input type="checkbox"/> WLS Key Uses Access Codes
2		<input type="checkbox"/> RF Jam Log after 5 Minutes	✓ <input type="checkbox"/> RF Jam Log after 30 Seconds
3		<input type="checkbox"/> Audible RF Jam Trouble Beeps	✓ <input type="checkbox"/> Silent RF Jam Trouble Beeps
4		<input type="checkbox"/> Double Hit Enabled	✓ <input type="checkbox"/> Double Hit Disabled
5		<input type="checkbox"/> Late to Close Enabled	✓ <input type="checkbox"/> Late to Close Disabled
6		<input type="checkbox"/> Daylight Savings Time Enabled	✓ <input type="checkbox"/> Daylight Savings Time Disabled
7		<input type="checkbox"/> For Future Use	✓ <input type="checkbox"/>
8		<input type="checkbox"/> Squawk on Away Key Arming/Disarming Only	✓ <input type="checkbox"/> Squawk on all Arming/Disarming

[018] Sixth System Options

Opt	Def	ON	OFF
1		<input type="checkbox"/> Test Transmission Exception Enabled	✓ <input type="checkbox"/> Test Transmission Exception Disabled
2		<input type="checkbox"/> For Future Use	✓ <input type="checkbox"/>
3		<input type="checkbox"/> For Future Use	✓ <input type="checkbox"/>
4		<input type="checkbox"/> For Future Use	✓ <input type="checkbox"/>
5		<input type="checkbox"/> Keypad Buzzer Follows Bell Enabled	✓ <input type="checkbox"/> Keypad Buzzer Follows Bell Disabled
6		<input type="checkbox"/> Cross Zoning Enabled	✓ <input type="checkbox"/> Police Code Enabled
7		<input type="checkbox"/> Exit Delay Restart Enabled (Enabled for SIA CP-01)	✓ <input type="checkbox"/> Exit Delay Restart Disabled
8		<input type="checkbox"/> AC Trouble Beeps Enabled	✓ <input type="checkbox"/> AC Trouble Beeps Disabled

[019] Seventh System Options

Opt	Def	ON	OFF
1		<input type="checkbox"/> For Future Use	✓ <input type="checkbox"/>
2		<input type="checkbox"/> Troubles are Latching	✓ <input type="checkbox"/> Troubles follow restore
3		<input type="checkbox"/> First Zone in Alarm Enabled	✓ <input type="checkbox"/> First Zone in Alarm Disabled
4		<input type="checkbox"/> For Future Use	✓ <input type="checkbox"/>
5		<input type="checkbox"/> For Future Use	✓ <input type="checkbox"/>
6		<input type="checkbox"/> Green Keypad LED Power Indication	✓ <input type="checkbox"/> Ready Indication
7		<input type="checkbox"/> [*][6] Accessable by All Users	✓ <input type="checkbox"/> Master Code Only
8		<input type="checkbox"/> For Future Use	✓ <input type="checkbox"/>

Keypad Zone Assignments

[020] Keypad Zone Assignments

 Only one keypad may be assigned to a zone.

Default

- 00 Keypad (slot 1) Zone
- 00 Keypad (slot 2) Zone
- 00 Keypad (slot 3) Zone
- 00 Keypad (slot 4) Zone
- 00 Keypad (slot 5) Zone
- 00 Keypad (slot 6) Zone
- 00 Keypad (slot 7) Zone
- 00 Keypad (slot 8) Zone

Only one keypad may be assigned to a slot. Only one zone can be assigned to a keypad. Valid entries are from 01 to 64.

[021] Eighth System Options

Opt	Def	ON		OFF
1	<input type="checkbox"/>	Access Code Entry Blocked During Entry Delay	✓	<input type="checkbox"/> Access Code Entry Not Blocked During Entry Delay
2	<input type="checkbox"/>	For Future Use	✓	<input type="checkbox"/>
3	<input type="checkbox"/>	For Future Use	✓	<input type="checkbox"/>
4	<input type="checkbox"/>	For Future Use	✓	<input type="checkbox"/>
5	<input type="checkbox"/>	For Future Use	✓	<input type="checkbox"/>
6	<input type="checkbox"/>	Keyswitch Disarming During Entry Delay Only	✓	<input type="checkbox"/> Keyswitch Disarming at Any Time
7	<input type="checkbox"/>	For Future Use	✓	<input type="checkbox"/>
8	<input type="checkbox"/>	For Future Use	✓	<input type="checkbox"/>

[022] Ninth System Options

Opt	Def	ON		OFF
1	<input type="checkbox"/>	Access Code Req'd for [*][1], [*][2], [*][3]	✓	<input type="checkbox"/> No Access Code Req'd for [*][1], [*][2], [*][3]
2	<input type="checkbox"/>	For Future Use	✓	<input type="checkbox"/>
3	<input type="checkbox"/>	For Future Use	✓	<input type="checkbox"/>
4	<input type="checkbox"/>	Master Code Bypasses Holdup Zones Only	✓	<input type="checkbox"/> Any Code Bypasses Holdup Zones
5	<input type="checkbox"/>	For Future Use	✓	<input type="checkbox"/>
6	<input type="checkbox"/>	RF Delinquency enabled	✓	<input type="checkbox"/> RF Delinquency disabled
7	<input type="checkbox"/>	For Future Use	✓	<input type="checkbox"/>
8	<input type="checkbox"/>	Audible Exit Delay for Stay Arming	✓	<input type="checkbox"/> Stay Arming Silent

[023] Tenth System Options

Opt	Def	ON		OFF
1	<input type="checkbox"/>	Fire Key Beeps Only	✓	<input type="checkbox"/> Fire Key Beeps and Sounds Bell
2	<input type="checkbox"/>	200 Baud Open/Close Identifier Toggle ON	✓	<input type="checkbox"/> 200 Baud Open/Close Identifier Toggle OFF
3	<input type="checkbox"/>	Test Transmission While Armed Only	✓	<input type="checkbox"/> Test Transmission While Armed/Disarmed
4	<input type="checkbox"/>	Test Transmission in Hours	✓	<input type="checkbox"/> Test Transmission in Days
5	<input type="checkbox"/>	Switching from AWAY to STAY disabled	✓	<input type="checkbox"/> AWAY to STAY toggle Option Permitted
6	<input type="checkbox"/>	2-way Audio will NOT Disconnect for a New Event	✓	<input type="checkbox"/> 2-way Audio Will Disconnect for a New Event
7	<input type="checkbox"/>	Trouble Beeps are Silent*	✓	<input type="checkbox"/> Trouble Beeps Sound Every 10 Seconds
8	<input type="checkbox"/>	Keyswitch Arm in Away Mode	✓	<input type="checkbox"/> Keyswitch arms in STAY or AWAY

* This option must be off for UL residential fire applications

[030] Zone Loop Response (Zones 1-8)

Opt	Def	ON		OFF
1	<input type="checkbox"/>	Zone 1 is Fast Loop Response	✓	<input type="checkbox"/> Zone 1 is Normal Loop Response
2	<input type="checkbox"/>	Zone 2 is Fast Loop Response	✓	<input type="checkbox"/> Zone 2 is Normal Loop Response
3	<input type="checkbox"/>	Zone 3 is Fast Loop Response	✓	<input type="checkbox"/> Zone 3 is Normal Loop Response
4	<input type="checkbox"/>	Zone 4 is Fast Loop Response	✓	<input type="checkbox"/> Zone 4 is Normal Loop Response
5	<input type="checkbox"/>	Zone 5 is Fast Loop Response	✓	<input type="checkbox"/> Zone 5 is Normal Loop Response
6	<input type="checkbox"/>	Zone 6 is Fast Loop Response	✓	<input type="checkbox"/> Zone 6 is Normal Loop Response
7	<input type="checkbox"/>	Zone 7 is Fast Loop Response	✓	<input type="checkbox"/> Zone 7 is Normal Loop Response
8	<input type="checkbox"/>	Zone 8 is Fast Loop Response	✓	<input type="checkbox"/> Zone 8 is Normal Loop Response

[101]-[164] Zone Attributes

Zone Attribute Defaults (Y = Option ON; N = Option OFF): **Bold entries are opposite for SIA CP-01**

Attribute:	1	2	3	4	5	6	7	8	9
ON OFF	Audible Silent	Steady Pulsed	Chime No	Bypass No	Force* No	Swing No	Tx. Delay No	Wireless Zn No	Cross Zn No
Zone Type:									
00 Null Zone	N	N	N	N	N	N	N	N	N
01 Delay 1	Y	Y	Y	Y	N	Y	N	N	N
02 Delay 2	Y	Y	Y	Y	N	Y	N	N	N
03 Instant	Y	Y	Y	Y	N	Y	N	N	N
04 Interior	Y	Y	N	Y	N	Y	N	N	N
05 Int. Stay/Away	Y	Y	N	Y	Y	Y	N	N	N
06 Dly. Stay/Away	Y	Y	N	Y	Y	Y	N	N	N
07 Dly. 24hr Fire (Hardw.)	Y	N	N	N	N	N	N	N	N
08 Stand. 24hr Fire (Hardw.)	Y	N	N	N	N	N	N	N	N
09 24hr Superv.	N	Y	N	N	Y	N	N	N	N
10 24hr Superv. Buzzer	N	Y	N	Y	N	N	N	N	N
11 24hr Burglary	Y	Y	N	Y	N	N	N	N	N
12 24hr Holdup	N	Y	N	N	N	N	N	N	N
13 24hr Gas	Y	N	N	N	N	N	N	N	N
14 24hr Heating	Y	N	N	N	N	N	N	N	N
15 24hr Medical	Y	Y	N	N	N	N	N	N	N
16 24hr Panic	Y	Y	N	N	N	N	N	N	N
17 24hr Emergency	Y	Y	N	N	N	N	N	N	N
18 24hr Sprinkler	Y	Y	N	N	N	N	N	N	N
19 24hr Water	Y	Y	N	N	N	N	N	N	N
20 24hr Freeze	Y	Y	N	N	N	N	N	N	N
21 24hr Latching Tamper	Y	Y	N	N	N	N	N	N	N
22 Momentary Keyswitch	N	N	N	N	Y	N	N	N	N
23 Maintained Keyswitch	N	N	N	N	Y	N	N	N	N
25 Interior Delay	Y	Y	N	Y	N	Y	N	N	N
26 24hr Non-alarm	N	N	N	N	Y	N	N	N	N
29 Auto Verified Fire	Y	N	N	N	N	N	N	N	N
30 Fire Supervisory	N	N	N	N	N	N	N	N	N
31 Day Zone	Y	Y	N	Y	Y	Y	Y	N	N
32 Instant Stay/Away	Y	Y	N	Y	N	N	N	N	N
35 24 hr Bell/Buzzer	Y	Y	N	Y	N	Y	N	N	N
36 24hr Non Latching Tamper	N	Y	N	N	N	Y	N	N	N
37 Night Zone	Y	Y	N	Y	Y	Y	N	N	N
87 Dly. 24hr Fire (Wireless)	Y	N	N	N	N	N	N	Y	N
88 Stand. 24hr Fire (Wireless)	Y	N	N	N	N	N	N	Y	N

1 * For UL installations, do not change attribute 5 (Force Arming) from the default setting.

Attribute:	10	11	12	13	14	15	16
ON OFF	Zone Attributes 10-13 For Future Use				NC Loops Config.	SEOL Config.	DEOL Config.
Zone Type:							
00 Null Zone	N	N	N	N	N	N	N
01 Delay 1	N	N	N	N	N	N	N
02 Delay 2	N	N	N	N	N	N	N
03 Instant	N	N	N	N	N	N	N
04 Interior	N	N	N	N	N	N	N
05 Int. Stay/Away	N	N	N	N	N	N	N
06 Dly. Stay/Away	N	N	N	N	N	N	N
07 Dly. 24hr Fire (Hardw.)	N	N	N	N	N	N	N
08 Stand. 24hr Fire (Hardw.)	N	N	N	N	N	N	N
09 24hr Superv.	N	N	N	N	N	N	N
10 24hr Superv. Buzzer	N	N	N	N	N	N	N
11 24hr Burglary	N	N	N	N	N	N	N
12 24hr Holdup	N	N	N	N	N	N	N
13 24hr Gas	N	N	N	N	N	N	N
14 24hr Heating	N	N	N	N	N	N	N
15 24hr Medical	N	N	N	N	N	N	N
16 24hr Panic	N	N	N	N	N	N	N

Attribute: ON OFF	10	11	12	13	14	15	16
	Zone Attributes 10-13 For Future Use				NC Loops Config.	SEOL Config.	DEOL Config.
17 24hr Emergency	N	N	N	N	N	N	N
18 24hr Sprinkler	N	N	N	N	N	N	N
19 24hr Water	N	N	N	N	N	N	N
20 24hr Freeze	N	N	N	N	N	N	N
21 24hr Latching Tamper	N	N	N	N	N	N	N
22 Momentary Keyswitch	N	N	N	N	N	N	N
23 Maintained Keyswitch	N	N	N	N	N	N	N
25 Interior Delay	N	N	N	N	N	N	N
26 24hr Non-alarm	N	N	N	N	N	N	N
29 Auto Verified Fire	N	N	N	N	N	N	N
30 Fire Supervisory	N	N	N	N	N	N	N
31 Day Zone	N	N	N	N	N	N	N
32 Instant Stay/Away	N	N	N	N	N	N	N
35 24 hr Bell/Buzzer	N	N	N	N	N	N	N
36 24hr Non Latching Tamper	N	N	N	N	N	N	N
37 Night Zone	N	N	N	N	N	N	N
87 Dly. 24hr Fire (Wireless)	N	N	N	N	N	N	N
88 Stand. 24hr Fire (Wireless)	N	N	N	N	N	N	N

Section	Zone #	Zone Type**	Audible/ Silent 1	Steady/ Pulsed 2	Chime No 3	Bypass No 4	Force* No 5	Swing No 6	Tx. Delay No 7	Wireless No 8	Cross Zn No 9
[101]	01	()	<input type="checkbox"/>	<input type="checkbox"/>	<input type="checkbox"/>	<input type="checkbox"/>	<input type="checkbox"/>	<input type="checkbox"/>	<input type="checkbox"/>	<input type="checkbox"/>	<input type="checkbox"/>
[102]	02	()	<input type="checkbox"/>	<input type="checkbox"/>	<input type="checkbox"/>	<input type="checkbox"/>	<input type="checkbox"/>	<input type="checkbox"/>	<input type="checkbox"/>	<input type="checkbox"/>	<input type="checkbox"/>
[103]	03	()	<input type="checkbox"/>	<input type="checkbox"/>	<input type="checkbox"/>	<input type="checkbox"/>	<input type="checkbox"/>	<input type="checkbox"/>	<input type="checkbox"/>	<input type="checkbox"/>	<input type="checkbox"/>
[104]	04	()	<input type="checkbox"/>	<input type="checkbox"/>	<input type="checkbox"/>	<input type="checkbox"/>	<input type="checkbox"/>	<input type="checkbox"/>	<input type="checkbox"/>	<input type="checkbox"/>	<input type="checkbox"/>
[105]	05	()	<input type="checkbox"/>	<input type="checkbox"/>	<input type="checkbox"/>	<input type="checkbox"/>	<input type="checkbox"/>	<input type="checkbox"/>	<input type="checkbox"/>	<input type="checkbox"/>	<input type="checkbox"/>
[106]	06	()	<input type="checkbox"/>	<input type="checkbox"/>	<input type="checkbox"/>	<input type="checkbox"/>	<input type="checkbox"/>	<input type="checkbox"/>	<input type="checkbox"/>	<input type="checkbox"/>	<input type="checkbox"/>
[107]	07	()	<input type="checkbox"/>	<input type="checkbox"/>	<input type="checkbox"/>	<input type="checkbox"/>	<input type="checkbox"/>	<input type="checkbox"/>	<input type="checkbox"/>	<input type="checkbox"/>	<input type="checkbox"/>
[108]	08	()	<input type="checkbox"/>	<input type="checkbox"/>	<input type="checkbox"/>	<input type="checkbox"/>	<input type="checkbox"/>	<input type="checkbox"/>	<input type="checkbox"/>	<input type="checkbox"/>	<input type="checkbox"/>
[109]	09	()	<input type="checkbox"/>	<input type="checkbox"/>	<input type="checkbox"/>	<input type="checkbox"/>	<input type="checkbox"/>	<input type="checkbox"/>	<input type="checkbox"/>	<input type="checkbox"/>	<input type="checkbox"/>
[110]	10	()	<input type="checkbox"/>	<input type="checkbox"/>	<input type="checkbox"/>	<input type="checkbox"/>	<input type="checkbox"/>	<input type="checkbox"/>	<input type="checkbox"/>	<input type="checkbox"/>	<input type="checkbox"/>
[111]	11	()	<input type="checkbox"/>	<input type="checkbox"/>	<input type="checkbox"/>	<input type="checkbox"/>	<input type="checkbox"/>	<input type="checkbox"/>	<input type="checkbox"/>	<input type="checkbox"/>	<input type="checkbox"/>
[112]	12	()	<input type="checkbox"/>	<input type="checkbox"/>	<input type="checkbox"/>	<input type="checkbox"/>	<input type="checkbox"/>	<input type="checkbox"/>	<input type="checkbox"/>	<input type="checkbox"/>	<input type="checkbox"/>
[113]	13	()	<input type="checkbox"/>	<input type="checkbox"/>	<input type="checkbox"/>	<input type="checkbox"/>	<input type="checkbox"/>	<input type="checkbox"/>	<input type="checkbox"/>	<input type="checkbox"/>	<input type="checkbox"/>
[114]	14	()	<input type="checkbox"/>	<input type="checkbox"/>	<input type="checkbox"/>	<input type="checkbox"/>	<input type="checkbox"/>	<input type="checkbox"/>	<input type="checkbox"/>	<input type="checkbox"/>	<input type="checkbox"/>
[115]	15	()	<input type="checkbox"/>	<input type="checkbox"/>	<input type="checkbox"/>	<input type="checkbox"/>	<input type="checkbox"/>	<input type="checkbox"/>	<input type="checkbox"/>	<input type="checkbox"/>	<input type="checkbox"/>
[116]	16	()	<input type="checkbox"/>	<input type="checkbox"/>	<input type="checkbox"/>	<input type="checkbox"/>	<input type="checkbox"/>	<input type="checkbox"/>	<input type="checkbox"/>	<input type="checkbox"/>	<input type="checkbox"/>
[117]	17	()	<input type="checkbox"/>	<input type="checkbox"/>	<input type="checkbox"/>	<input type="checkbox"/>	<input type="checkbox"/>	<input type="checkbox"/>	<input type="checkbox"/>	<input type="checkbox"/>	<input type="checkbox"/>
[118]	18	()	<input type="checkbox"/>	<input type="checkbox"/>	<input type="checkbox"/>	<input type="checkbox"/>	<input type="checkbox"/>	<input type="checkbox"/>	<input type="checkbox"/>	<input type="checkbox"/>	<input type="checkbox"/>
[119]	19	()	<input type="checkbox"/>	<input type="checkbox"/>	<input type="checkbox"/>	<input type="checkbox"/>	<input type="checkbox"/>	<input type="checkbox"/>	<input type="checkbox"/>	<input type="checkbox"/>	<input type="checkbox"/>
[120]	20	()	<input type="checkbox"/>	<input type="checkbox"/>	<input type="checkbox"/>	<input type="checkbox"/>	<input type="checkbox"/>	<input type="checkbox"/>	<input type="checkbox"/>	<input type="checkbox"/>	<input type="checkbox"/>
[121]	21	()	<input type="checkbox"/>	<input type="checkbox"/>	<input type="checkbox"/>	<input type="checkbox"/>	<input type="checkbox"/>	<input type="checkbox"/>	<input type="checkbox"/>	<input type="checkbox"/>	<input type="checkbox"/>
[122]	22	()	<input type="checkbox"/>	<input type="checkbox"/>	<input type="checkbox"/>	<input type="checkbox"/>	<input type="checkbox"/>	<input type="checkbox"/>	<input type="checkbox"/>	<input type="checkbox"/>	<input type="checkbox"/>
[123]	23	()	<input type="checkbox"/>	<input type="checkbox"/>	<input type="checkbox"/>	<input type="checkbox"/>	<input type="checkbox"/>	<input type="checkbox"/>	<input type="checkbox"/>	<input type="checkbox"/>	<input type="checkbox"/>
[124]	24	()	<input type="checkbox"/>	<input type="checkbox"/>	<input type="checkbox"/>	<input type="checkbox"/>	<input type="checkbox"/>	<input type="checkbox"/>	<input type="checkbox"/>	<input type="checkbox"/>	<input type="checkbox"/>
[125]	25	()	<input type="checkbox"/>	<input type="checkbox"/>	<input type="checkbox"/>	<input type="checkbox"/>	<input type="checkbox"/>	<input type="checkbox"/>	<input type="checkbox"/>	<input type="checkbox"/>	<input type="checkbox"/>
[126]	26	()	<input type="checkbox"/>	<input type="checkbox"/>	<input type="checkbox"/>	<input type="checkbox"/>	<input type="checkbox"/>	<input type="checkbox"/>	<input type="checkbox"/>	<input type="checkbox"/>	<input type="checkbox"/>
[127]	27	()	<input type="checkbox"/>	<input type="checkbox"/>	<input type="checkbox"/>	<input type="checkbox"/>	<input type="checkbox"/>	<input type="checkbox"/>	<input type="checkbox"/>	<input type="checkbox"/>	<input type="checkbox"/>
[128]	28	()	<input type="checkbox"/>	<input type="checkbox"/>	<input type="checkbox"/>	<input type="checkbox"/>	<input type="checkbox"/>	<input type="checkbox"/>	<input type="checkbox"/>	<input type="checkbox"/>	<input type="checkbox"/>
[129]	29	()	<input type="checkbox"/>	<input type="checkbox"/>	<input type="checkbox"/>	<input type="checkbox"/>	<input type="checkbox"/>	<input type="checkbox"/>	<input type="checkbox"/>	<input type="checkbox"/>	<input type="checkbox"/>
[130]	30	()	<input type="checkbox"/>	<input type="checkbox"/>	<input type="checkbox"/>	<input type="checkbox"/>	<input type="checkbox"/>	<input type="checkbox"/>	<input type="checkbox"/>	<input type="checkbox"/>	<input type="checkbox"/>
[131]	31	()	<input type="checkbox"/>	<input type="checkbox"/>	<input type="checkbox"/>	<input type="checkbox"/>	<input type="checkbox"/>	<input type="checkbox"/>	<input type="checkbox"/>	<input type="checkbox"/>	<input type="checkbox"/>
[132]	32	()	<input type="checkbox"/>	<input type="checkbox"/>	<input type="checkbox"/>	<input type="checkbox"/>	<input type="checkbox"/>	<input type="checkbox"/>	<input type="checkbox"/>	<input type="checkbox"/>	<input type="checkbox"/>
[133]	33	()	<input type="checkbox"/>	<input type="checkbox"/>	<input type="checkbox"/>	<input type="checkbox"/>	<input type="checkbox"/>	<input type="checkbox"/>	<input type="checkbox"/>	<input type="checkbox"/>	<input type="checkbox"/>

Section	Zone #	Zone Type**	Audible/ Silent 1	Steady/ Pulsed 2	Chime No 3	Bypass No 4	Force* No 5	Swing No 6	Tx. Delay No 7	Wireless No 8	Cross Zn No 9
[134]	34	()	<input type="checkbox"/>	<input type="checkbox"/>	<input type="checkbox"/>	<input type="checkbox"/>	<input type="checkbox"/>	<input type="checkbox"/>	<input type="checkbox"/>	<input type="checkbox"/>	<input type="checkbox"/>
[135]	35	()	<input type="checkbox"/>	<input type="checkbox"/>	<input type="checkbox"/>	<input type="checkbox"/>	<input type="checkbox"/>	<input type="checkbox"/>	<input type="checkbox"/>	<input type="checkbox"/>	<input type="checkbox"/>
[136]	36	()	<input type="checkbox"/>	<input type="checkbox"/>	<input type="checkbox"/>	<input type="checkbox"/>	<input type="checkbox"/>	<input type="checkbox"/>	<input type="checkbox"/>	<input type="checkbox"/>	<input type="checkbox"/>
[137]	37	()	<input type="checkbox"/>	<input type="checkbox"/>	<input type="checkbox"/>	<input type="checkbox"/>	<input type="checkbox"/>	<input type="checkbox"/>	<input type="checkbox"/>	<input type="checkbox"/>	<input type="checkbox"/>
[138]	38	()	<input type="checkbox"/>	<input type="checkbox"/>	<input type="checkbox"/>	<input type="checkbox"/>	<input type="checkbox"/>	<input type="checkbox"/>	<input type="checkbox"/>	<input type="checkbox"/>	<input type="checkbox"/>
[139]	39	()	<input type="checkbox"/>	<input type="checkbox"/>	<input type="checkbox"/>	<input type="checkbox"/>	<input type="checkbox"/>	<input type="checkbox"/>	<input type="checkbox"/>	<input type="checkbox"/>	<input type="checkbox"/>
[140]	40	()	<input type="checkbox"/>	<input type="checkbox"/>	<input type="checkbox"/>	<input type="checkbox"/>	<input type="checkbox"/>	<input type="checkbox"/>	<input type="checkbox"/>	<input type="checkbox"/>	<input type="checkbox"/>
[141]	41	()	<input type="checkbox"/>	<input type="checkbox"/>	<input type="checkbox"/>	<input type="checkbox"/>	<input type="checkbox"/>	<input type="checkbox"/>	<input type="checkbox"/>	<input type="checkbox"/>	<input type="checkbox"/>
[142]	42	()	<input type="checkbox"/>	<input type="checkbox"/>	<input type="checkbox"/>	<input type="checkbox"/>	<input type="checkbox"/>	<input type="checkbox"/>	<input type="checkbox"/>	<input type="checkbox"/>	<input type="checkbox"/>
[143]	43	()	<input type="checkbox"/>	<input type="checkbox"/>	<input type="checkbox"/>	<input type="checkbox"/>	<input type="checkbox"/>	<input type="checkbox"/>	<input type="checkbox"/>	<input type="checkbox"/>	<input type="checkbox"/>
[144]	44	()	<input type="checkbox"/>	<input type="checkbox"/>	<input type="checkbox"/>	<input type="checkbox"/>	<input type="checkbox"/>	<input type="checkbox"/>	<input type="checkbox"/>	<input type="checkbox"/>	<input type="checkbox"/>
[145]	45	()	<input type="checkbox"/>	<input type="checkbox"/>	<input type="checkbox"/>	<input type="checkbox"/>	<input type="checkbox"/>	<input type="checkbox"/>	<input type="checkbox"/>	<input type="checkbox"/>	<input type="checkbox"/>
[146]	46	()	<input type="checkbox"/>	<input type="checkbox"/>	<input type="checkbox"/>	<input type="checkbox"/>	<input type="checkbox"/>	<input type="checkbox"/>	<input type="checkbox"/>	<input type="checkbox"/>	<input type="checkbox"/>
[147]	47	()	<input type="checkbox"/>	<input type="checkbox"/>	<input type="checkbox"/>	<input type="checkbox"/>	<input type="checkbox"/>	<input type="checkbox"/>	<input type="checkbox"/>	<input type="checkbox"/>	<input type="checkbox"/>
[148]	48	()	<input type="checkbox"/>	<input type="checkbox"/>	<input type="checkbox"/>	<input type="checkbox"/>	<input type="checkbox"/>	<input type="checkbox"/>	<input type="checkbox"/>	<input type="checkbox"/>	<input type="checkbox"/>
[149]	49	()	<input type="checkbox"/>	<input type="checkbox"/>	<input type="checkbox"/>	<input type="checkbox"/>	<input type="checkbox"/>	<input type="checkbox"/>	<input type="checkbox"/>	<input type="checkbox"/>	<input type="checkbox"/>
[150]	50	()	<input type="checkbox"/>	<input type="checkbox"/>	<input type="checkbox"/>	<input type="checkbox"/>	<input type="checkbox"/>	<input type="checkbox"/>	<input type="checkbox"/>	<input type="checkbox"/>	<input type="checkbox"/>
[151]	51	()	<input type="checkbox"/>	<input type="checkbox"/>	<input type="checkbox"/>	<input type="checkbox"/>	<input type="checkbox"/>	<input type="checkbox"/>	<input type="checkbox"/>	<input type="checkbox"/>	<input type="checkbox"/>
[152]	52	()	<input type="checkbox"/>	<input type="checkbox"/>	<input type="checkbox"/>	<input type="checkbox"/>	<input type="checkbox"/>	<input type="checkbox"/>	<input type="checkbox"/>	<input type="checkbox"/>	<input type="checkbox"/>
[153]	53	()	<input type="checkbox"/>	<input type="checkbox"/>	<input type="checkbox"/>	<input type="checkbox"/>	<input type="checkbox"/>	<input type="checkbox"/>	<input type="checkbox"/>	<input type="checkbox"/>	<input type="checkbox"/>
[154]	54	()	<input type="checkbox"/>	<input type="checkbox"/>	<input type="checkbox"/>	<input type="checkbox"/>	<input type="checkbox"/>	<input type="checkbox"/>	<input type="checkbox"/>	<input type="checkbox"/>	<input type="checkbox"/>
[155]	55	()	<input type="checkbox"/>	<input type="checkbox"/>	<input type="checkbox"/>	<input type="checkbox"/>	<input type="checkbox"/>	<input type="checkbox"/>	<input type="checkbox"/>	<input type="checkbox"/>	<input type="checkbox"/>
[156]	56	()	<input type="checkbox"/>	<input type="checkbox"/>	<input type="checkbox"/>	<input type="checkbox"/>	<input type="checkbox"/>	<input type="checkbox"/>	<input type="checkbox"/>	<input type="checkbox"/>	<input type="checkbox"/>
[157]	57	()	<input type="checkbox"/>	<input type="checkbox"/>	<input type="checkbox"/>	<input type="checkbox"/>	<input type="checkbox"/>	<input type="checkbox"/>	<input type="checkbox"/>	<input type="checkbox"/>	<input type="checkbox"/>
[158]	58	()	<input type="checkbox"/>	<input type="checkbox"/>	<input type="checkbox"/>	<input type="checkbox"/>	<input type="checkbox"/>	<input type="checkbox"/>	<input type="checkbox"/>	<input type="checkbox"/>	<input type="checkbox"/>
[159]	59	()	<input type="checkbox"/>	<input type="checkbox"/>	<input type="checkbox"/>	<input type="checkbox"/>	<input type="checkbox"/>	<input type="checkbox"/>	<input type="checkbox"/>	<input type="checkbox"/>	<input type="checkbox"/>
[160]	60	()	<input type="checkbox"/>	<input type="checkbox"/>	<input type="checkbox"/>	<input type="checkbox"/>	<input type="checkbox"/>	<input type="checkbox"/>	<input type="checkbox"/>	<input type="checkbox"/>	<input type="checkbox"/>
[161]	61	()	<input type="checkbox"/>	<input type="checkbox"/>	<input type="checkbox"/>	<input type="checkbox"/>	<input type="checkbox"/>	<input type="checkbox"/>	<input type="checkbox"/>	<input type="checkbox"/>	<input type="checkbox"/>
[162]	62	()	<input type="checkbox"/>	<input type="checkbox"/>	<input type="checkbox"/>	<input type="checkbox"/>	<input type="checkbox"/>	<input type="checkbox"/>	<input type="checkbox"/>	<input type="checkbox"/>	<input type="checkbox"/>
[163]	63	()	<input type="checkbox"/>	<input type="checkbox"/>	<input type="checkbox"/>	<input type="checkbox"/>	<input type="checkbox"/>	<input type="checkbox"/>	<input type="checkbox"/>	<input type="checkbox"/>	<input type="checkbox"/>
[164]	64	()	<input type="checkbox"/>	<input type="checkbox"/>	<input type="checkbox"/>	<input type="checkbox"/>	<input type="checkbox"/>	<input type="checkbox"/>	<input type="checkbox"/>	<input type="checkbox"/>	<input type="checkbox"/>

Section	Zone #	Zone Type**	For Future Use 10	For Future Use 11	For Future Use 12	For Future Use 13	NC Loops Config. 14	SEOL Config. 15	DEOL Config. 16
[101]	01	()	<input type="checkbox"/>	<input type="checkbox"/>	<input type="checkbox"/>	<input type="checkbox"/>	<input type="checkbox"/>	<input type="checkbox"/>	<input type="checkbox"/>
[102]	02	()	<input type="checkbox"/>	<input type="checkbox"/>	<input type="checkbox"/>	<input type="checkbox"/>	<input type="checkbox"/>	<input type="checkbox"/>	<input type="checkbox"/>
[103]	03	()	<input type="checkbox"/>	<input type="checkbox"/>	<input type="checkbox"/>	<input type="checkbox"/>	<input type="checkbox"/>	<input type="checkbox"/>	<input type="checkbox"/>
[104]	04	()	<input type="checkbox"/>	<input type="checkbox"/>	<input type="checkbox"/>	<input type="checkbox"/>	<input type="checkbox"/>	<input type="checkbox"/>	<input type="checkbox"/>
[105]	05	()	<input type="checkbox"/>	<input type="checkbox"/>	<input type="checkbox"/>	<input type="checkbox"/>	<input type="checkbox"/>	<input type="checkbox"/>	<input type="checkbox"/>
[106]	06	()	<input type="checkbox"/>	<input type="checkbox"/>	<input type="checkbox"/>	<input type="checkbox"/>	<input type="checkbox"/>	<input type="checkbox"/>	<input type="checkbox"/>
[107]	07	()	<input type="checkbox"/>	<input type="checkbox"/>	<input type="checkbox"/>	<input type="checkbox"/>	<input type="checkbox"/>	<input type="checkbox"/>	<input type="checkbox"/>
[108]	08	()	<input type="checkbox"/>	<input type="checkbox"/>	<input type="checkbox"/>	<input type="checkbox"/>	<input type="checkbox"/>	<input type="checkbox"/>	<input type="checkbox"/>

 Zone attributes 10-16 only apply to zones 1-8.

System Timers

[165] Maximum Dialing Attempts to Each Telephone Number

Default 005 Valid entries are 001-005 attempts

For UL Listed Installations, 5-10 dialing attempts are required.

[166] Post Dial Wait for Handshake (All Formats)

Default 040 Valid entries are 001-255 seconds

[167] T-LINK Interface Communications Wait for Acknowledge

Default 020 Valid entries are 001-255 seconds

[168] Set Clock Forward (Daylight Saving Time)

Def 003	Month	<input type="text"/> <input type="text"/> <input type="text"/> <input type="text"/>	Valid Entries 001-012
Def 002	Week	<input type="text"/> <input type="text"/> <input type="text"/> <input type="text"/>	Valid Entries 000-005
Def 000	Day	<input type="text"/> <input type="text"/> <input type="text"/> <input type="text"/>	Valid Entries 001-031
Def 002	Hour	<input type="text"/> <input type="text"/> <input type="text"/> <input type="text"/>	Valid Entries 000-022
Def 001	Increment	<input type="text"/> <input type="text"/> <input type="text"/> <input type="text"/>	Valid Entries 001-002

[169] Set Clock Back (Standard Time)

Def 011	Month	<input type="text"/> <input type="text"/> <input type="text"/> <input type="text"/>	Valid Entries 001-012
Def 001	Week	<input type="text"/> <input type="text"/> <input type="text"/> <input type="text"/>	Valid Entries 000-005
Def 000	Day	<input type="text"/> <input type="text"/> <input type="text"/> <input type="text"/>	Valid Entries 001-031
Def 002	Hour	<input type="text"/> <input type="text"/> <input type="text"/> <input type="text"/>	Valid Entries 000-023
Def 001	Decrement	<input type="text"/> <input type="text"/> <input type="text"/> <input type="text"/>	Valid Entries 001-002

[170] PGM Output Timer

Default 005 Valid entries are 001-255 seconds

[171] Tamper PGM Output Timer

Default 000 Valid entries are 000-255 minutes

[175] Auto-arm Postpone Timer

Default 000 Valid entries are 001-255 minutes, 000 disables automatic arming

[176] Cross Zone/Police Code Timer

Default 060 Valid entries are 001-255 seconds/minutes

Automatic Arming Schedule

Enter a four-digit number (HH:MM) for each day that the system will Auto-arm on each partition (Section [181] for Partition 1 through section [188] for Partition 8). All entries are disabled (9999) by default. Valid entries are 0000-2359.

	Sunday	Monday	Tuesday	Wednesday	Thursday	Friday	Saturday
[181]	<input type="text"/> <input type="text"/> <input type="text"/> <input type="text"/>	<input type="text"/> <input type="text"/> <input type="text"/> <input type="text"/>	<input type="text"/> <input type="text"/> <input type="text"/> <input type="text"/>	<input type="text"/> <input type="text"/> <input type="text"/> <input type="text"/>	<input type="text"/> <input type="text"/> <input type="text"/> <input type="text"/>	<input type="text"/> <input type="text"/> <input type="text"/> <input type="text"/>	<input type="text"/> <input type="text"/> <input type="text"/> <input type="text"/>
[182]	<input type="text"/> <input type="text"/> <input type="text"/> <input type="text"/>	<input type="text"/> <input type="text"/> <input type="text"/> <input type="text"/>	<input type="text"/> <input type="text"/> <input type="text"/> <input type="text"/>	<input type="text"/> <input type="text"/> <input type="text"/> <input type="text"/>	<input type="text"/> <input type="text"/> <input type="text"/> <input type="text"/>	<input type="text"/> <input type="text"/> <input type="text"/> <input type="text"/>	<input type="text"/> <input type="text"/> <input type="text"/> <input type="text"/>
[183]	<input type="text"/> <input type="text"/> <input type="text"/> <input type="text"/>	<input type="text"/> <input type="text"/> <input type="text"/> <input type="text"/>	<input type="text"/> <input type="text"/> <input type="text"/> <input type="text"/>	<input type="text"/> <input type="text"/> <input type="text"/> <input type="text"/>	<input type="text"/> <input type="text"/> <input type="text"/> <input type="text"/>	<input type="text"/> <input type="text"/> <input type="text"/> <input type="text"/>	<input type="text"/> <input type="text"/> <input type="text"/> <input type="text"/>
[184]	<input type="text"/> <input type="text"/> <input type="text"/> <input type="text"/>	<input type="text"/> <input type="text"/> <input type="text"/> <input type="text"/>	<input type="text"/> <input type="text"/> <input type="text"/> <input type="text"/>	<input type="text"/> <input type="text"/> <input type="text"/> <input type="text"/>	<input type="text"/> <input type="text"/> <input type="text"/> <input type="text"/>	<input type="text"/> <input type="text"/> <input type="text"/> <input type="text"/>	<input type="text"/> <input type="text"/> <input type="text"/> <input type="text"/>
[185]	<input type="text"/> <input type="text"/> <input type="text"/> <input type="text"/>	<input type="text"/> <input type="text"/> <input type="text"/> <input type="text"/>	<input type="text"/> <input type="text"/> <input type="text"/> <input type="text"/>	<input type="text"/> <input type="text"/> <input type="text"/> <input type="text"/>	<input type="text"/> <input type="text"/> <input type="text"/> <input type="text"/>	<input type="text"/> <input type="text"/> <input type="text"/> <input type="text"/>	<input type="text"/> <input type="text"/> <input type="text"/> <input type="text"/>
[186]	<input type="text"/> <input type="text"/> <input type="text"/> <input type="text"/>	<input type="text"/> <input type="text"/> <input type="text"/> <input type="text"/>	<input type="text"/> <input type="text"/> <input type="text"/> <input type="text"/>	<input type="text"/> <input type="text"/> <input type="text"/> <input type="text"/>	<input type="text"/> <input type="text"/> <input type="text"/> <input type="text"/>	<input type="text"/> <input type="text"/> <input type="text"/> <input type="text"/>	<input type="text"/> <input type="text"/> <input type="text"/> <input type="text"/>
[187]	<input type="text"/> <input type="text"/> <input type="text"/> <input type="text"/>	<input type="text"/> <input type="text"/> <input type="text"/> <input type="text"/>	<input type="text"/> <input type="text"/> <input type="text"/> <input type="text"/>	<input type="text"/> <input type="text"/> <input type="text"/> <input type="text"/>	<input type="text"/> <input type="text"/> <input type="text"/> <input type="text"/>	<input type="text"/> <input type="text"/> <input type="text"/> <input type="text"/>	<input type="text"/> <input type="text"/> <input type="text"/> <input type="text"/>
[188]	<input type="text"/> <input type="text"/> <input type="text"/> <input type="text"/>	<input type="text"/> <input type="text"/> <input type="text"/> <input type="text"/>	<input type="text"/> <input type="text"/> <input type="text"/> <input type="text"/>	<input type="text"/> <input type="text"/> <input type="text"/> <input type="text"/>	<input type="text"/> <input type="text"/> <input type="text"/> <input type="text"/>	<input type="text"/> <input type="text"/> <input type="text"/> <input type="text"/>	<input type="text"/> <input type="text"/> <input type="text"/> <input type="text"/>

[190] No Activity Arming Pre-Alert Time

Default Partition

001 All Valid entries are 001-255 minutes, 000 for no pre-alert

No Activity Arming Timers - Default is [000] for all partitions

Section	Partition		
[191]	1	<input type="text"/>	Valid entries are 001-255 minutes, 000 to disable
[192]	2	<input type="text"/>	Valid entries are 001-255 minutes, 000 to disable
[193]	3	<input type="text"/>	Valid entries are 001-255 minutes, 000 to disable
[194]	4	<input type="text"/>	Valid entries are 001-255 minutes, 000 to disable
[195]	5	<input type="text"/>	Valid entries are 001-255 minutes, 000 to disable
[196]	6	<input type="text"/>	Valid entries are 001-255 minutes, 000 to disable
[197]	7	<input type="text"/>	Valid entries are 001-255 minutes, 000 to disable
[198]	8	<input type="text"/>	Valid entries are 001-255 minutes, 000 to disable

[199] Auto-arming Pre-Alert Timer

Default: 004 Valid entries are 001-255 minutes

Partition Programming

[201] Partition Selection Mask

Opt	Def	ON	OFF
1	✓	<input type="checkbox"/> Partition 1 is enabled	<input type="checkbox"/> Cannot be disabled
2		<input type="checkbox"/> Partition 2 is enabled	✓ <input type="checkbox"/> Disabled
3		<input type="checkbox"/> Partition 3 is enabled	✓ <input type="checkbox"/> Disabled
4		<input type="checkbox"/> Partition 4 is enabled	✓ <input type="checkbox"/> Disabled
5		<input type="checkbox"/> Partition 5 is enabled	✓ <input type="checkbox"/> Disabled
6		<input type="checkbox"/> Partition 6 is enabled	✓ <input type="checkbox"/> Disabled
7		<input type="checkbox"/> Partition 7 is enabled	✓ <input type="checkbox"/> Disabled
8		<input type="checkbox"/> Partition 8 is enabled	✓ <input type="checkbox"/> Disabled

i For the PC1864 and PC1832 Default is partition 1, zones 1-16 ON.
For the PC1616 Default is partition 1, zones 1-6 ON

Partition 1 Zone Assignment		Partition 2 Zone Assignment		Partition 3 Zone Assignment		Partition 4 Zone Assignment	
[202] 1-8	<input type="text"/>	[210] 1-8	<input type="text"/>	[218] 1-8	<input type="text"/>	[226] 1-8	<input type="text"/>
[203] 9-16	<input type="text"/>	[211] 9-16	<input type="text"/>	[219] 9-16	<input type="text"/>	[227] 9-16	<input type="text"/>
[204] 17-24	<input type="text"/>	[212] 17-24	<input type="text"/>	[220] 17-24	<input type="text"/>	[228] 17-24	<input type="text"/>
[205] 25-32	<input type="text"/>	[213] 25-32	<input type="text"/>	[221] 25-32	<input type="text"/>	[229] 25-32	<input type="text"/>
[206] 33-40	<input type="text"/>	[214] 33-40	<input type="text"/>	[222] 33-40	<input type="text"/>	[230] 33-40	<input type="text"/>
[207] 41-48	<input type="text"/>	[215] 41-48	<input type="text"/>	[223] 41-48	<input type="text"/>	[231] 41-48	<input type="text"/>
[208] 49-56	<input type="text"/>	[216] 49-56	<input type="text"/>	[224] 49-56	<input type="text"/>	[232] 49-56	<input type="text"/>
[209] 57-64	<input type="text"/>	[217] 57-64	<input type="text"/>	[225] 57-64	<input type="text"/>	[233] 57-64	<input type="text"/>
Partition 5 Zone Assignment		Partition 6 Zone Assignment		Partition 7 Zone Assignment		Partition 8 Zone Assignment	
[234] 1-8	<input type="text"/>	[242] 1-8	<input type="text"/>	[250] 1-8	<input type="text"/>	[258] 1-8	<input type="text"/>
[235] 9-16	<input type="text"/>	[243] 9-16	<input type="text"/>	[251] 9-16	<input type="text"/>	[259] 9-16	<input type="text"/>
[236] 17-24	<input type="text"/>	[244] 17-24	<input type="text"/>	[252] 17-24	<input type="text"/>	[260] 17-24	<input type="text"/>
[237] 25-32	<input type="text"/>	[245] 25-32	<input type="text"/>	[253] 25-32	<input type="text"/>	[261] 25-32	<input type="text"/>
[238] 33-40	<input type="text"/>	[246] 33-40	<input type="text"/>	[254] 33-40	<input type="text"/>	[262] 33-40	<input type="text"/>
[239] 41-48	<input type="text"/>	[247] 41-48	<input type="text"/>	[255] 41-48	<input type="text"/>	[263] 41-48	<input type="text"/>
[240] 49-56	<input type="text"/>	[248] 49-56	<input type="text"/>	[256] 49-56	<input type="text"/>	[264] 49-56	<input type="text"/>
[241] 57-64	<input type="text"/>	[249] 57-64	<input type="text"/>	[257] 57-64	<input type="text"/>	[265] 57-64	<input type="text"/>

Communications

[301] First Telephone Number (32 Digits)

When using T-Link, program DCAA as the phone number.

[302] Second Telephone Number (32 Digits)

[303] Third Telephone Number (32 Digits)

[304] Call Waiting Cancel String (6 Digits) - This feature is activated in Section 382 Opt 4

_____ Default = DB70EF Program unused digits with Hex F

i All six digits must be entered for changes to be saved. Fill unused digit spaces with 'F'.

Account Codes

Enter a 6-digit account number for the system account code. SIA will use this account code for all eight partitions. Only SIA supports 6-digit account codes. If the last two digits of the account code are FF, the panel will only use the first four digits.

Section [310] System Account Code DEF [FFFFFF]

Enter a four-digit account number for each active partition.

[311] Partition 1 Account Number

[312] Partition 2 Account Number

[313] Partition 3 Account Number

[314] Partition 4 Account Number

[315] Partition 5 Account Number

[316] Partition 6 Account Number

[317] Partition 7 Account Number

[318] Partition 8 Account Number

i All Account Numbers codes are defaulted to FFFF.

Reporting Codes

[320]-[323] Alarm Reporting Codes, Zones 01-64

i All Reporting Codes defaulted to FF unless otherwise indicated.

Section								
[320]	Zone 01	Zone 02	Zone 03	Zone 04	Zone 05	Zone 06	Zone 07	Zone 08
	_____	_____	_____	_____	_____	_____	_____	_____
	Zone 09	Zone 10	Zone 11	Zone 12	Zone 13	Zone 14	Zone 15	Zone 16
	_____	_____	_____	_____	_____	_____	_____	_____
[321]	Zone 17	Zone 18	Zone 19	Zone 20	Zone 21	Zone 22	Zone 23	Zone 24
	_____	_____	_____	_____	_____	_____	_____	_____
	Zone 25	Zone 26	Zone 27	Zone 28	Zone 29	Zone 30	Zone 31	Zone 32
	_____	_____	_____	_____	_____	_____	_____	_____
[322]	Zone 33	Zone 34	Zone 35	Zone 36	Zone 37	Zone 38	Zone 39	Zone 40
	_____	_____	_____	_____	_____	_____	_____	_____
	Zone 41	Zone 42	Zone 43	Zone 44	Zone 45	Zone 46	Zone 47	Zone 48
	_____	_____	_____	_____	_____	_____	_____	_____
[323]	Zone 49	Zone 50	Zone 51	Zone 52	Zone 53	Zone 54	Zone 55	Zone 56
	_____	_____	_____	_____	_____	_____	_____	_____
	Zone 57	Zone 58	Zone 59	Zone 60	Zone 61	Zone 62	Zone 63	Zone 64
	_____	_____	_____	_____	_____	_____	_____	_____

[324]-[327] Alarm Restoral Reporting Codes, Zones 01-64

Section

[324]	Zone 01 □□□	Zone 02 □□□	Zone 03 □□□	Zone 04 □□□	Zone 05 □□□	Zone 06 □□□	Zone 07 □□□	Zone 08 □□□
	Zone 09 □□□	Zone 10 □□□	Zone 11 □□□	Zone 12 □□□	Zone 13 □□□	Zone 14 □□□	Zone 15 □□□	Zone 16 □□□
[325]	Zone 17 □□□	Zone 18 □□□	Zone 19 □□□	Zone 20 □□□	Zone 21 □□□	Zone 22 □□□	Zone 23 □□□	Zone 24 □□□
	Zone 25 □□□	Zone 26 □□□	Zone 27 □□□	Zone 28 □□□	Zone 29 □□□	Zone 30 □□□	Zone 31 □□□	Zone 32 □□□
[326]	Zone 33 □□□	Zone 34 □□□	Zone 35 □□□	Zone 36 □□□	Zone 37 □□□	Zone 38 □□□	Zone 39 □□□	Zone 40 □□□
	Zone 41 □□□	Zone 42 □□□	Zone 43 □□□	Zone 44 □□□	Zone 45 □□□	Zone 46 □□□	Zone 47 □□□	Zone 48 □□□
[327]	Zone 49 □□□	Zone 50 □□□	Zone 51 □□□	Zone 52 □□□	Zone 53 □□□	Zone 54 □□□	Zone 55 □□□	Zone 56 □□□
	Zone 57 □□□	Zone 58 □□□	Zone 59 □□□	Zone 60 □□□	Zone 61 □□□	Zone 62 □□□	Zone 63 □□□	Zone 64 □□□

[328] Miscellaneous Alarm Reporting Codes

- Duress Alarm
- Opening After Alarm
- Recent Closing
- Zone Expander Supervisory Alarm
- Zone Expander Supervisory Restore
- Cross Zone Police Code Alarm
- Burglary Not Verified
- Alarm Cancelled

[329] Priority Alarm and Restoral

- Keypad Fire Alarm
- Keypad Auxiliary Alarm
- Keypad Panic Alarm
- Auxiliary Input Alarm
- Keypad Fire Restoral
- Keypad Auxiliary Restoral
- Keypad Panic Restoral
- Auxiliary Input Restore

[330]-[333] Tamper Reporting Codes, Zones 01-64

Section

[330]	Zone 01 □□□	Zone 02 □□□	Zone 03 □□□	Zone 04 □□□	Zone 05 □□□	Zone 06 □□□	Zone 07 □□□	Zone 08 □□□
	Zone 09 □□□	Zone 10 □□□	Zone 11 □□□	Zone 12 □□□	Zone 13 □□□	Zone 14 □□□	Zone 15 □□□	Zone 16 □□□
[331]	Zone 17 □□□	Zone 18 □□□	Zone 19 □□□	Zone 20 □□□	Zone 21 □□□	Zone 22 □□□	Zone 23 □□□	Zone 24 □□□
	Zone 25 □□□	Zone 26 □□□	Zone 27 □□□	Zone 28 □□□	Zone 29 □□□	Zone 30 □□□	Zone 31 □□□	Zone 32 □□□
[332]	Zone 33 □□□	Zone 34 □□□	Zone 35 □□□	Zone 36 □□□	Zone 37 □□□	Zone 38 □□□	Zone 39 □□□	Zone 40 □□□
	Zone 41 □□□	Zone 42 □□□	Zone 43 □□□	Zone 44 □□□	Zone 45 □□□	Zone 46 □□□	Zone 47 □□□	Zone 48 □□□
[333]	Zone 49 □□□	Zone 50 □□□	Zone 51 □□□	Zone 52 □□□	Zone 53 □□□	Zone 54 □□□	Zone 55 □□□	Zone 56 □□□
	Zone 57 □□□	Zone 58 □□□	Zone 59 □□□	Zone 60 □□□	Zone 61 □□□	Zone 62 □□□	Zone 63 □□□	Zone 64 □□□

[334]-[337] Tamper Restoral Reporting Codes, Zones 01-64**Section**

[334]	Zone 01 _ _	Zone 02 _ _	Zone 03 _ _	Zone 04 _ _	Zone 05 _ _	Zone 06 _ _	Zone 07 _ _	Zone 08 _ _
	Zone 09 _ _	Zone 10 _ _	Zone 11 _ _	Zone 12 _ _	Zone 13 _ _	Zone 14 _ _	Zone 15 _ _	Zone 16 _ _
[335]	Zone 17 _ _	Zone 18 _ _	Zone 19 _ _	Zone 20 _ _	Zone 21 _ _	Zone 22 _ _	Zone 23 _ _	Zone 24 _ _
	Zone 25 _ _	Zone 26 _ _	Zone 27 _ _	Zone 28 _ _	Zone 29 _ _	Zone 30 _ _	Zone 31 _ _	Zone 32 _ _
[336]	Zone 33 _ _	Zone 34 _ _	Zone 35 _ _	Zone 36 _ _	Zone 37 _ _	Zone 38 _ _	Zone 39 _ _	Zone 40 _ _
	Zone 41 _ _	Zone 42 _ _	Zone 43 _ _	Zone 44 _ _	Zone 45 _ _	Zone 46 _ _	Zone 47 _ _	Zone 48 _ _
[337]	Zone 49 _ _	Zone 50 _ _	Zone 51 _ _	Zone 52 _ _	Zone 53 _ _	Zone 54 _ _	Zone 55 _ _	Zone 56 _ _
	Zone 57 _ _	Zone 58 _ _	Zone 59 _ _	Zone 60 _ _	Zone 61 _ _	Zone 62 _ _	Zone 63 _ _	Zone 64 _ _

[338] Miscellaneous Tamper Reporting Codes

- |_|_| General System Tamper
- |_|_| General System Tamper Rest.
- |_|_| Keypad Lockout

[339]-[340] Closing (Arming) Reporting Codes, Access Codes 1-32**Section**

[339]	Code 1 _ _	Code 2 _ _	Code 3 _ _	Code 4 _ _	Code 5 _ _	Code 6 _ _	Code 7 _ _	Code 8 _ _
	Code 9 _ _	Code 10 _ _	Code 11 _ _	Code 12 _ _	Code 13 _ _	Code 14 _ _	Code 15 _ _	Code 16 _ _
[340]	Code 17 _ _	Code 18 _ _	Code 19 _ _	Code 20 _ _	Code 21 _ _	Code 22 _ _	Code 23 _ _	Code 24 _ _
	Code 25 _ _	Code 26 _ _	Code 27 _ _	Code 28 _ _	Code 29 _ _	Code 30 _ _	Code 31 _ _	Code 32 _ _

[341] Miscellaneous Closing (Arming) Reporting Codes

- |_|_| For Future Use
- |_|_| For Future Use
- |_|_| For Future Use
- |_|_| For Future Use
- |_0_|_0_| Automatic Zone Bypass
- |_|_| Partial Closing
- |_|_| Special Closing
- |_|_| Late to Close
- |_|_| Exit Fault

[342]-[343] Opening (Disarming) Reporting Codes, Access Codes 1-32**Section**

[342]	Code 1 _ _	Code 2 _ _	Code 3 _ _	Code 4 _ _	Code 5 _ _	Code 6 _ _	Code 7 _ _	Code 8 _ _
	Code 9 _ _	Code 10 _ _	Code 11 _ _	Code 12 _ _	Code 13 _ _	Code 14 _ _	Code 15 _ _	Code 16 _ _
[343]	Code 17 _ _	Code 18 _ _	Code 19 _ _	Code 20 _ _	Code 21 _ _	Code 22 _ _	Code 23 _ _	Code 24 _ _
	Code 25 _ _	Code 26 _ _	Code 27 _ _	Code 28 _ _	Code 29 _ _	Code 30 _ _	Code 31 _ _	Code 32 _ _

[344] Miscellaneous Opening (Disarming) Reporting Codes

- For Future Use
- For Future Use
- For Future Use
- For Future Use
- For Future Use
- Auto Arm Cancellation/Postpone
- Special Opening

[345] Maintenance Alarm Reporting Codes

- Battery Trouble Alarm
- AC Failure Trouble Alarm
- Bell Circuit Trouble Alarm
- Fire Trouble Alarm
- Auxiliary Power Supply Trouble Alarm
- TLM Trouble Code
- General System Trouble
- General System Supervisory

[346] Maintenance Restoral Reporting Codes

- Battery Trouble Restoral
- AC Failure Trouble Restoral
- Bell Circuit Trouble Restoral
- Fire Trouble Restoral
- Auxiliary Power Supply Trouble Restoral
- TLM Restoral
- General System Trouble Restoral
- General System Supervisory Restoral

[347] Miscellaneous Maintenance Reporting Codes

- Telephone Number 1 FTC Restore
- Telephone Number 2 FTC Restore
- Event Buffer 75% Full Since Last Upload
- DLS Lead IN
- DLS Lead OUT
- Zone Fault Alarm
- Zone Fault Restore
- Delinquency Code
- General Zone Low Battery Alarm
- General Zone Low Battery Restoral
- Installer Lead Out
- Installer Lead In

[348] Test Transmission Reporting Codes

- Walk Test End
- Walk Begin
- Periodic Test Transmission with Trouble
- Periodic Test Transmission
- System Test
- For Future Use

[349] PC5700 Maintenance Reporting Codes

 *The PC5700 is available in Canada only.*

- PC5700 Ground Fault Trouble
- PC5700 Ground Fault Restoral
- PC5700 TLM Line 1 Trouble
- PC5700 TLM Line 1 Restoral
- PC5700 TLM Line 2 Trouble
- PC5700 TLM Line 2 Restoral

[350] Communicator Format Options

Default

04|_|_|1st Telephone Number

04|_|_|2nd Telephone Number

- | | | | |
|-------------------------------------|--|------------------------------------|--------------------------|
| 01 20 BPS, 1400 HZ handshake | 05 Pager | 08 10 BPS, 2300Hz handshake | 11 For Future Use |
| 02 20 BPS, 2300 HZ handshake | 06 Residential Dial** | 09 Private Line | 12 For Furure Use |
| 03 DTMF CONTACT ID | 07 10 BPS, 1400Hz handshake | 10 Scantronics | 13 CESA 200 |
| 04 SIA FSK | **Failure to communicate using Residential Dial will not generate a Failed To Communicate Trouble. | | |

Call Direction Options

[351]-[358] Alarm/Restore Communicator Call Directions

Section	Partition	Option 1 1st Telephone Number (Def ON)	Option 2 2nd Telephone Number (Def OFF)	Option 3 Not Used (Def OFF)	Option 4 Not Used (Def OFF)	Option 5 Alt Comm (Def ON)	Options 6,7,8 Future Use
[351]	1	_	_	_	_	_	_
[352]	2	_	_	_	_	_	_
[353]	3	_	_	_	_	_	_
[354]	4	_	_	_	_	_	_
[355]	5	_	_	_	_	_	_
[356]	6	_	_	_	_	_	_
[357]	7	_	_	_	_	_	_
[358]	8	_	_	_	_	_	_

[359]-[366] Tamper/Restore Communicator Call Directions

Section	Partition	Option 1 1st Telephone Number (Def ON)	Option 2 2nd Telephone Number (Def OFF)	Option 3 Not Used (Def OFF)	Option 4 Not Used (Def OFF)	Option 5 Alt Comm (Def ON)	Options 6,7,8 Future Use
[359]	1	_	_	_	_	_	_
[360]	2	_	_	_	_	_	_
[361]	3	_	_	_	_	_	_
[362]	4	_	_	_	_	_	_
[363]	5	_	_	_	_	_	_
[364]	6	_	_	_	_	_	_
[365]	7	_	_	_	_	_	_
[366]	8	_	_	_	_	_	_

[367]-[374] Opening/Closing Communicator Call Directions

Section	Partition	Option 1 1st Telephone Number (Def OFF)	Option 2 2nd Telephone Number (Def OFF)	Option 3 Not Used (Def OFF)	Option 4 Not Used (Def OFF)	Option 5 Alt Comm (Def OFF)	Options 6,7,8 Future Use
[367]	1	_	_	_	_	_	_
[368]	2	_	_	_	_	_	_
[369]	3	_	_	_	_	_	_
[370]	4	_	_	_	_	_	_
[371]	5	_	_	_	_	_	_
[372]	6	_	_	_	_	_	_
[373]	7	_	_	_	_	_	_
[374]	8	_	_	_	_	_	_

[375] System Maintenance Communicator Call Directions

Section	Option 1 1st Telephone Number (Def ON)	Option 2 2nd Telephone Number (Def OFF)	Option 3 Not Used (Def OFF)	Option 4 Not Used (Def OFF)	Option 5 Alt Comm (Def ON)	Options 6,7,8 Future Use
[375]	<input type="checkbox"/>	<input type="checkbox"/>	<input type="checkbox"/>	<input type="checkbox"/>	<input type="checkbox"/>	<input type="checkbox"/>

[376] System Test Transmissions Communicator Call Directions

Section	Option 1 1st Telephone Number (Def ON)	Option 2 2nd Telephone Number (Def OFF)	Option 3 Not Used (Def OFF)	Option 4 Not Used (Def OFF)	Option 5 Alt Comm (Def ON)	Options 6,7,8 Future Use
[376]	<input type="checkbox"/>	<input type="checkbox"/>	<input type="checkbox"/>	<input type="checkbox"/>	<input type="checkbox"/>	<input type="checkbox"/>

[377] Communication Variables

Default

003	<input type="checkbox"/> _0_1_0_1_1_	Swinger Shutdown (Alarms and Rest)	001-014 Transmissions
003	<input type="checkbox"/> _0_1_0_1_3_	Swinger Shutdown (Tampers and Rest)	001-014 Transmissions, 000=disabled
003	<input type="checkbox"/> _0_1_0_1_3_	Swinger Shutdown (Maint and Rest)	001-014 Transmissions, 000=disabled
000	<input type="checkbox"/> _0_1_3_1_0_	Communication Delay	000-255 seconds
030	<input type="checkbox"/> _0_1_3_1_0_	AC Failure Communication Delay	001-255 minutes, 000=disabled
010	<input type="checkbox"/> _0_1_1_1_0_	TLM Trouble Delay	No. of checks required - valid entries 002 - 255)
030	<input type="checkbox"/> _0_1_3_1_0_	Test Transmission Cycle (land line)	001-255 days/minutes†
030	<input type="checkbox"/> _0_1_3_1_0_	For Future Use	
007	<input type="checkbox"/> _0_1_0_1_7_	Zone Low Battery Transmission Delay	000-255 days
030	<input type="checkbox"/> _0_1_3_1_0_	Delinquency Transmission Cycle	001-255 days/hours
000	<input type="checkbox"/> _0_1_0_1_5_	Communications Cancelled Window	001-255 minutes

†Dependent on programming in section [702], option [3].

i The values in gray *GRAY* are required for CP-01 compliant systems

i For UL installations, the Entry Delay plus Communication Delay time must not exceed 60 seconds.

[378] Test Transmission Time of Day

Default

9999 _ _ _ _ Valid entries are 0000-2359 (9999 to disable)

[379] Periodic DLS Time of Day

Default

9999 _ _ _ _ Valid entries are 0000-2359 (9999 for Random, FFFF to disable)

[380] First Communicator Options

Opt	Def	ON	OFF
1	✓	<input type="checkbox"/> Communications Enabled	<input type="checkbox"/> Communications Disabled
2		<input type="checkbox"/> Restorals on Bell Time-out	✓ <input type="checkbox"/> Restorals Follow Zones
3		<input type="checkbox"/> Pulse Dialing	✓ <input type="checkbox"/> DTMF Dialing
4		<input type="checkbox"/> Switch to Pulse Dialing on 5th Attempt	✓ <input type="checkbox"/> DTMF Dial For All Attempts
5		<input type="checkbox"/> 3rd Telephone Number Enabled	✓ <input type="checkbox"/> 3rd Telephone Number Disabled
6		<input type="checkbox"/> Alternate Dial (1st & 3rd)	✓ <input type="checkbox"/> Call 1st Number, Back up to 3rd
7		<input type="checkbox"/> For Future Use	✓ <input type="checkbox"/>
8		<input type="checkbox"/> Delinquency Follows Zone Activity (Hours)	✓ <input type="checkbox"/> Delinquency Follows Arming (Days)

[381] Second Communicator Options

Opt	Def	ON	OFF
1	<input type="checkbox"/>	Open After Alarm Keypad Ringback Enabled	✓ <input type="checkbox"/> Open After Alarm Keypad Ringback Disabled
2	<input type="checkbox"/>	Open After Alarm Bell Ringback Enabled	✓ <input type="checkbox"/> Open After Alarm Bell Ringback Disabled
3	<input type="checkbox"/>	SIA Sends Programmed Reporting Codes	✓ <input type="checkbox"/> SIA Sends Automatic Reporting Codes
4	<input type="checkbox"/>	Closing Confirmation Enabled	✓ <input type="checkbox"/> Closing Confirmation Disabled
5	✓ <input type="checkbox"/>	Talk/Listen on Phone Lines 1/3	<input type="checkbox"/> No Talk/Listen on Phone Lines 1/3
6	✓ <input type="checkbox"/>	Talk/Listen on Phone Line 2	<input type="checkbox"/> No Talk/Listen on Phone Line 2
7	<input type="checkbox"/>	Contact ID Uses Programmed Reporting Codes	✓ <input type="checkbox"/> Contact ID Uses Automatic Reporting Codes
8	<input type="checkbox"/>	Communications Priority Enabled	✓ <input type="checkbox"/> Communications Priority Disabled

[382] Third Communicator Options

Opt	Def	ON	OFF
1	<input type="checkbox"/>	Contact ID Partial Closing Identifier is "5"	✓ <input type="checkbox"/> Contact ID Partial Closing Identifier is "4"
2	<input type="checkbox"/>	Alarm Communications Enabled During Walk Test*	✓ <input type="checkbox"/> Alarm Communications Disabled During Walk Test
3	<input type="checkbox"/>	Communication Cancelled Message Enabled (ON for SIA CP-01)	✓ <input type="checkbox"/> Communication Cancelled Message Disabled
4	<input type="checkbox"/>	Call Waiting Cancel Enabled**	✓ <input type="checkbox"/> Call Waiting Cancel Disabled
5	<input type="checkbox"/>	T-Link Interface Enabled	✓ <input type="checkbox"/> T-Link Interface Disabled
6	<input type="checkbox"/>	AC Failure Transmission Delay is in Hours	✓ <input type="checkbox"/> AC Failure Transmission Delay is in Minutes
7	<input type="checkbox"/>	Number of Dialing Attempt for Residential Dial is 1	✓ <input type="checkbox"/> Residential Dial Follows Dialing Attempts Counter
8	<input type="checkbox"/>	For Future Use	✓ <input type="checkbox"/>

*This option must remain OFF for SIA CP-01 installations.

** A Call Waiting Cancel on a non-Call Waiting line will prevent successful connection to the central station.

[383] Fourth Communicator Options

Opt	Def	ON	OFF
1	<input type="checkbox"/>	Account Code Follows Phone Number	✓ <input type="checkbox"/> Account Code Follows Partition
2	<input type="checkbox"/>	For Future Use	✓ <input type="checkbox"/>

[389] T-Link Fault Check Timer

Default: 003|_|_| Valid entries are 001-255 minutes

DLS Downloading**[401] Downloading Option Codes**

Opt	Def	ON	OFF
1	<input type="checkbox"/>	Answering Machine/Double Call enabled	✓ <input type="checkbox"/> Answering Machine/Double Call disable
2	<input type="checkbox"/>	User Can Enable DLS Window	✓ <input type="checkbox"/> User Cannot Enable DLS Window
3	<input type="checkbox"/>	Call Back Enabled	✓ <input type="checkbox"/> Call Back Disabled
4	<input type="checkbox"/>	User Initiated Call Up Enabled	✓ <input type="checkbox"/> User Initiated Call Up Disabled
5	<input type="checkbox"/>	Auto Event Buffer Upload Enabled	✓ <input type="checkbox"/> Auto Event Buffer Upload Disabled
6	<input type="checkbox"/>	300 Baud Call Up	✓ <input type="checkbox"/> 110 Baud Call Up
7	<input type="checkbox"/>	For Future Use	✓ <input type="checkbox"/>
8	<input type="checkbox"/>	For Future Use	✓ <input type="checkbox"/>

[402] DLS Downloading Telephone Number (32 Digits)

D | | | | | | | | | | | | | | | | | | | | | | | | | | | | | | | | | | | | | | | |

[403]-[404] DLS Downloading Access Code / Panel ID Code (Enter 6 Hexadecimal Digits)

Panel	Default	[403] Downloading Access Code	[404] Panel ID Code
PC1616	161600	_ _ _ _ _	_ _ _ _ _
PC1832	183200	_ _ _ _ _	_ _ _ _ _
PC1864	186400	_ _ _ _ _	_ _ _ _ _

[405] Answering Machine Double Call Timer
Default 060 |_|_|_|_| (000-255 seconds)

[406] Number of Rings to Answer On
Default 000 |_|_|_|_| (000-010 rings)

[499] Initiate PC-Link Downloading
Enter [499][Installer Code][499]

[501]- [554] Programmable Output Attributes

Program only the following attributes for the PGM options listed. All others will be ignored. PGM options are programmed in [009], [010] & [011].
PGM Attribute Defaults (Y = Attribute ON; N = Attribute OFF; Blank = Attribute not available):

Attribute:	1	2	3	4	5	6	7	8
ON	Not used	Not used	True Output	Follows Timer	Code Req.	Not used	Not used	Not used
OFF	—	—	Inverted	On / Off	No Code Req.	—	—	—
PGM Option								
[01] Residential Burglary / Fire Bell Output			Y					
[02] For Future Use								
[03] Sensor Reset [✳][7][2]			Y					
[04] 2-Wire Smoke Support (PGM2 only)			Y					
[05] System Armed Status			Y					
[06] Ready To Arm			Y					
[07] Keypad Buzzer Follower Mode			Y					
[08] Courtesy Pulse			Y					
[11] System Tamper (all sources, zones, keypad, modules)			Y					
[12] TLM and Alarm			Y					
[13] Kiss-off Output			Y	Y				
[14] Ground Start Pulse			Y	Y				
[15] Remote Operation (DLS Support)			Y	Y				
[16] For Future Use			Y					
[17] Away Armed Status			Y					
[18] Stay Armed Status			Y					
[19] Command Output #1, [✳][7][1]			Y	Y	Y			
[20] Command Output #2, [✳][7][2]			Y	Y	N			
[21] Command Output #3, [✳][7][3]			Y	Y	N			
[22] Command Output #4, [✳][7][4]			Y	Y	N			
[23] 24 Hr Silent Input (PGM2 only)			Y					
[24] 24 Hr Audible Input (PGM2 only)			Y					
[25] Delayed Burglary & Fire Output			Y					
[26] Battery Test Output			Y					
[28] Holdup Output			Y					
[30] Partition Status Alarm Memory Output			Y					
[33]Bell Status and Programming Access Output			Y					
[34]Away Armed with no Zone Bypassed Status			Y					

Attribute: PGM Option		1	2	3	4	5	6	7	8
[09] System Trouble	ON	Serv. req.	AC Fail	TLM Fault	FTC	Zone Fault	Zone Tmp.	Zn. Low Bat.	Loss of Clock
	OFF	Disabled	Disabled	Disabled	Disabled	Disabled	Disabled	Disabled	Disabled
		Y	Y	Y	Y	Y	Y	Y	Y
[10] System Event	ON	Burg. Evnt.	Fire Evnt.	Panic Evnt.	Med. Evnt.	Supv. Evnt.	Priority Evnt.	Holdup Evnt.	Follows Timer*
	OFF	Disabled	Disabled	Disabled	Disabled	Disabled	Disabled	Disabled	Latched
		Y	Y	Y	Y	Y	Y	Y	N
[31] Alternate Communicator	ON	Fire Alarm	Panic Alarm	Burglary Alarm	Open/Close	Zone Aut.o Bypass	Medical Alarm	Police Code	Active When true
	OFF	Disabled	Disabled	Disabled	Disabled	Disabled	Disabled	Disabled	Latched
		N	N	N	N	N	N	N	N
[32] Open After Alarm	ON	Future Use	Future Use	Future Use	Future Use	Future Use	Future Use	Future Use	Follows Timer
	OFF								Latched
		N	N	N	N	N	N	N	N
[29], [35]-[41] Zone Follower	ON	Future Use	Future Use	True Output	Future Use	Future Use	Future Use	Future Use	AND Logic
	OFF			Inverted					OR Logic
		N	N	N	N	N	N	N	N

Section	PGM #	Output Type*	1	2	3	4	5	6	7	8
Main Board										
[501]	1	()	<input type="checkbox"/>	<input type="checkbox"/>	<input type="checkbox"/>	<input type="checkbox"/>	<input type="checkbox"/>	<input type="checkbox"/>	<input type="checkbox"/>	<input type="checkbox"/>
[502]	2	()	<input type="checkbox"/>	<input type="checkbox"/>	<input type="checkbox"/>	<input type="checkbox"/>	<input type="checkbox"/>	<input type="checkbox"/>	<input type="checkbox"/>	<input type="checkbox"/>
Main Board / PC5208										
[503]**	3	()	<input type="checkbox"/>	<input type="checkbox"/>	<input type="checkbox"/>	<input type="checkbox"/>	<input type="checkbox"/>	<input type="checkbox"/>	<input type="checkbox"/>	<input type="checkbox"/>
[504]**	4	()	<input type="checkbox"/>	<input type="checkbox"/>	<input type="checkbox"/>	<input type="checkbox"/>	<input type="checkbox"/>	<input type="checkbox"/>	<input type="checkbox"/>	<input type="checkbox"/>

*Record here based on programming in [009], [010] and [011].

** These two sections allow you to program both PGM3 and PGM4 on the main panel, and the first two PGM outputs on the PC5208. If you use both the main panel and the PC5208 outputs, PGM3 will work the same as the first PC5208 output, and PGM4 will work the same as the second PC5208 output.

Section	PGM #	Output Type*	1	2	3	4	5	6	7	8
PC5208										
[505]	5	()	<input type="checkbox"/>	<input type="checkbox"/>	<input type="checkbox"/>	<input type="checkbox"/>	<input type="checkbox"/>	<input type="checkbox"/>	<input type="checkbox"/>	<input type="checkbox"/>
[506]	6	()	<input type="checkbox"/>	<input type="checkbox"/>	<input type="checkbox"/>	<input type="checkbox"/>	<input type="checkbox"/>	<input type="checkbox"/>	<input type="checkbox"/>	<input type="checkbox"/>
[507]	7	()	<input type="checkbox"/>	<input type="checkbox"/>	<input type="checkbox"/>	<input type="checkbox"/>	<input type="checkbox"/>	<input type="checkbox"/>	<input type="checkbox"/>	<input type="checkbox"/>
[508]	8	()	<input type="checkbox"/>	<input type="checkbox"/>	<input type="checkbox"/>	<input type="checkbox"/>	<input type="checkbox"/>	<input type="checkbox"/>	<input type="checkbox"/>	<input type="checkbox"/>
[509]	9	()	<input type="checkbox"/>	<input type="checkbox"/>	<input type="checkbox"/>	<input type="checkbox"/>	<input type="checkbox"/>	<input type="checkbox"/>	<input type="checkbox"/>	<input type="checkbox"/>
[510]	10	()	<input type="checkbox"/>	<input type="checkbox"/>	<input type="checkbox"/>	<input type="checkbox"/>	<input type="checkbox"/>	<input type="checkbox"/>	<input type="checkbox"/>	<input type="checkbox"/>
PC5204										
[511]	11	()	<input type="checkbox"/>	<input type="checkbox"/>	<input type="checkbox"/>	<input type="checkbox"/>	<input type="checkbox"/>	<input type="checkbox"/>	<input type="checkbox"/>	<input type="checkbox"/>
[512]	12	()	<input type="checkbox"/>	<input type="checkbox"/>	<input type="checkbox"/>	<input type="checkbox"/>	<input type="checkbox"/>	<input type="checkbox"/>	<input type="checkbox"/>	<input type="checkbox"/>
[513]	13	()	<input type="checkbox"/>	<input type="checkbox"/>	<input type="checkbox"/>	<input type="checkbox"/>	<input type="checkbox"/>	<input type="checkbox"/>	<input type="checkbox"/>	<input type="checkbox"/>
[514]	14	()	<input type="checkbox"/>	<input type="checkbox"/>	<input type="checkbox"/>	<input type="checkbox"/>	<input type="checkbox"/>	<input type="checkbox"/>	<input type="checkbox"/>	<input type="checkbox"/>

*Record here based on programming in [009], [010] and [011].

PGM Output Partition Assignment

Section	PGM #	Partition: 1	2	3	4	5	6	7	8
Main Board									
[551]	1	<input type="checkbox"/>	<input type="checkbox"/>	<input type="checkbox"/>	<input type="checkbox"/>	<input type="checkbox"/>	<input type="checkbox"/>	<input type="checkbox"/>	<input type="checkbox"/>
[552]	2	<input type="checkbox"/>	<input type="checkbox"/>	<input type="checkbox"/>	<input type="checkbox"/>	<input type="checkbox"/>	<input type="checkbox"/>	<input type="checkbox"/>	<input type="checkbox"/>
Main Board / PC5208									
[553]	3	<input type="checkbox"/>	<input type="checkbox"/>	<input type="checkbox"/>	<input type="checkbox"/>	<input type="checkbox"/>	<input type="checkbox"/>	<input type="checkbox"/>	<input type="checkbox"/>
[554]	4	<input type="checkbox"/>	<input type="checkbox"/>	<input type="checkbox"/>	<input type="checkbox"/>	<input type="checkbox"/>	<input type="checkbox"/>	<input type="checkbox"/>	<input type="checkbox"/>
PC5208									
[555]	5	<input type="checkbox"/>	<input type="checkbox"/>	<input type="checkbox"/>	<input type="checkbox"/>	<input type="checkbox"/>	<input type="checkbox"/>	<input type="checkbox"/>	<input type="checkbox"/>
[556]	6	<input type="checkbox"/>	<input type="checkbox"/>	<input type="checkbox"/>	<input type="checkbox"/>	<input type="checkbox"/>	<input type="checkbox"/>	<input type="checkbox"/>	<input type="checkbox"/>
[557]	7	<input type="checkbox"/>	<input type="checkbox"/>	<input type="checkbox"/>	<input type="checkbox"/>	<input type="checkbox"/>	<input type="checkbox"/>	<input type="checkbox"/>	<input type="checkbox"/>
[558]	8	<input type="checkbox"/>	<input type="checkbox"/>	<input type="checkbox"/>	<input type="checkbox"/>	<input type="checkbox"/>	<input type="checkbox"/>	<input type="checkbox"/>	<input type="checkbox"/>
[559]	9	<input type="checkbox"/>	<input type="checkbox"/>	<input type="checkbox"/>	<input type="checkbox"/>	<input type="checkbox"/>	<input type="checkbox"/>	<input type="checkbox"/>	<input type="checkbox"/>
[560]	10	<input type="checkbox"/>	<input type="checkbox"/>	<input type="checkbox"/>	<input type="checkbox"/>	<input type="checkbox"/>	<input type="checkbox"/>	<input type="checkbox"/>	<input type="checkbox"/>
PC5204									
[561]	11	<input type="checkbox"/>	<input type="checkbox"/>	<input type="checkbox"/>	<input type="checkbox"/>	<input type="checkbox"/>	<input type="checkbox"/>	<input type="checkbox"/>	<input type="checkbox"/>
[562]	12	<input type="checkbox"/>	<input type="checkbox"/>	<input type="checkbox"/>	<input type="checkbox"/>	<input type="checkbox"/>	<input type="checkbox"/>	<input type="checkbox"/>	<input type="checkbox"/>
[563]	13	<input type="checkbox"/>	<input type="checkbox"/>	<input type="checkbox"/>	<input type="checkbox"/>	<input type="checkbox"/>	<input type="checkbox"/>	<input type="checkbox"/>	<input type="checkbox"/>
[564]	14	<input type="checkbox"/>	<input type="checkbox"/>	<input type="checkbox"/>	<input type="checkbox"/>	<input type="checkbox"/>	<input type="checkbox"/>	<input type="checkbox"/>	<input type="checkbox"/>

Zone Follower PGM Zone Assignment

If a Zone Follower PGM type 29, 35-41 is used, the PGM Output Partition Assignment will be treated as a PGM Output Zone Assignment. Each Zone Follower PGM applies to a different bank of zones as in the below table. Record the assignments above.

Option:	1	2	3	4	5	6	7	8
[29] Zone Follower	Zone 1	Zone 2	Zone 3	Zone 4	Zone 5	Zone 6	Zone 7	Zone 8
[35] Zone Follower	Zone 9	Zone 10	Zone 11	Zone 12	Zone 13	Zone 14	Zone 15	Zone 16
[36] Zone Follower	Zone 17	Zone 18	Zone 19	Zone 20	Zone 21	Zone 22	Zone 23	Zone 24
[37] Zone Follower	Zone 25	Zone 26	Zone 27	Zone 28	Zone 29	Zone 30	Zone 31	Zone 32
[38] Zone Follower	Zone 33	Zone 34	Zone 35	Zone 36	Zone 37	Zone 38	Zone 39	Zone 40
[39] Zone Follower	Zone 41	Zone 42	Zone 43	Zone 44	Zone 45	Zone 46	Zone 47	Zone 48
[40] Zone Follower	Zone 49	Zone 50	Zone 51	Zone 52	Zone 53	Zone 54	Zone 55	Zone 56
[41] Zone Follower	Zone 57	Zone 58	Zone 59	Zone 60	Zone 61	Zone 62	Zone 63	Zone 64

Extended Reporting Codes

[601]-[604] Closing (Arming) Reporting Codes, Access Codes 33-95

Section	Code 33	Code 34	Code 35	Code 36	Code 37	Code 38	Code 39	Code 40
[601]	<input type="checkbox"/>	<input type="checkbox"/>	<input type="checkbox"/>	<input type="checkbox"/>	<input type="checkbox"/>	<input type="checkbox"/>	<input type="checkbox"/>	<input type="checkbox"/>
	Code 41	Code 42	Code 43	Code 44	Code 45	Code 46	Code 47	Code 48
	<input type="checkbox"/>	<input type="checkbox"/>	<input type="checkbox"/>	<input type="checkbox"/>	<input type="checkbox"/>	<input type="checkbox"/>	<input type="checkbox"/>	<input type="checkbox"/>
[602]	Code 49	Code 50	Code 51	Code 52	Code 53	Code 54	Code 55	Code 56
	<input type="checkbox"/>	<input type="checkbox"/>	<input type="checkbox"/>	<input type="checkbox"/>	<input type="checkbox"/>	<input type="checkbox"/>	<input type="checkbox"/>	<input type="checkbox"/>
	Code 57	Code 58	Code 59	Code 60	Code 61	Code 62	Code 63	Code 64
[603]	<input type="checkbox"/>	<input type="checkbox"/>	<input type="checkbox"/>	<input type="checkbox"/>	<input type="checkbox"/>	<input type="checkbox"/>	<input type="checkbox"/>	<input type="checkbox"/>
	Code 65	Code 66	Code 67	Code 68	Code 69	Code 70	Code 71	Code 72
	<input type="checkbox"/>	<input type="checkbox"/>	<input type="checkbox"/>	<input type="checkbox"/>	<input type="checkbox"/>	<input type="checkbox"/>	<input type="checkbox"/>	<input type="checkbox"/>
[604]	Code 73	Code 74	Code 75	Code 76	Code 77	Code 78	Code 79	Code 80
	<input type="checkbox"/>	<input type="checkbox"/>	<input type="checkbox"/>	<input type="checkbox"/>	<input type="checkbox"/>	<input type="checkbox"/>	<input type="checkbox"/>	<input type="checkbox"/>
	Code 81	Code 82	Code 83	Code 84	Code 85	Code 86	Code 87	Code 88
	<input type="checkbox"/>	<input type="checkbox"/>	<input type="checkbox"/>	<input type="checkbox"/>	<input type="checkbox"/>	<input type="checkbox"/>	<input type="checkbox"/>	<input type="checkbox"/>
	Code 89	Code 90	Code 91	Code 92	Code 93	Code 94	Code 95	
	<input type="checkbox"/>	<input type="checkbox"/>	<input type="checkbox"/>	<input type="checkbox"/>	<input type="checkbox"/>	<input type="checkbox"/>	<input type="checkbox"/>	

[605]-[608] Opening (Disarming) Reporting Codes, Access Codes 33-95

Section

[605]	Code 33 _ _	Code 34 _ _	Code 35 _ _	Code 36 _ _	Code 37 _ _	Code 38 _ _	Code 39 _ _	Code 40 _ _
	Code 41 _ _	Code 42 _ _	Code 43 _ _	Code 44 _ _	Code 45 _ _	Code 46 _ _	Code 47 _ _	Code 48 _ _
[606]	Code 49 _ _	Code 50 _ _	Code 51 _ _	Code 52 _ _	Code 53 _ _	Code 54 _ _	Code 55 _ _	Code 56 _ _
	Code 57 _ _	Code 58 _ _	Code 59 _ _	Code 60 _ _	Code 61 _ _	Code 62 _ _	Code 63 _ _	Code 64 _ _
[607]	Code 65 _ _	Code 66 _ _	Code 67 _ _	Code 68 _ _	Code 69 _ _	Code 70 _ _	Code 71 _ _	Code 72 _ _
	Code 73 _ _	Code 74 _ _	Code 75 _ _	Code 76 _ _	Code 77 _ _	Code 78 _ _	Code 79 _ _	Code 80 _ _
[608]	Code 81 _ _	Code 82 _ _	Code 83 _ _	Code 84 _ _	Code 85 _ _	Code 86 _ _	Code 87 _ _	Code 88 _ _
	Code 89 _ _	Code 90 _ _	Code 91 _ _	Code 92 _ _	Code 93 _ _	Code 94 _ _	Code 95 _ _	

Automatic Disarming Schedule

Enter a four-digit number (HH:MM) for each day that the system will auto-disarm for each partition (Section [681] for Partition 1 through section [688] for Partition 8). Valid entries are 0000-2359. All entries are disabled (9999) by default.

	Sunday	Monday	Tuesday	Wednesday	Thursday	Friday	Saturday
[681]	_ : _	_ : _	_ : _	_ : _	_ : _	_ : _	_ : _
[682]	_ : _	_ : _	_ : _	_ : _	_ : _	_ : _	_ : _
[683]	_ : _	_ : _	_ : _	_ : _	_ : _	_ : _	_ : _
[684]	_ : _	_ : _	_ : _	_ : _	_ : _	_ : _	_ : _
[685]	_ : _	_ : _	_ : _	_ : _	_ : _	_ : _	_ : _
[686]	_ : _	_ : _	_ : _	_ : _	_ : _	_ : _	_ : _
[687]	_ : _	_ : _	_ : _	_ : _	_ : _	_ : _	_ : _
[688]	_ : _	_ : _	_ : _	_ : _	_ : _	_ : _	_ : _

Auto-Disarm Holiday Schedule

Enter a six-digit number (MM:DD:YY) for each day that the system will skip auto-disarm for each partition (Section [181] for Partition 1 through section [188] for Partition 8). Program [99][99][99] to disable Auto-Disarm schedule. All entries are disabled by default.

[691]	Holiday 1 _ : _ : _	Holiday 2 _ : _ : _	Holiday 3 _ : _ : _	Holiday 4 _ : _ : _	Holiday 5 _ : _ : _	Holiday 6 _ : _ : _	Holiday 7 _ : _ : _
	Holiday 8 _ : _ : _	Holiday 9 _ : _ : _	Holiday 10 _ : _ : _	Holiday 11 _ : _ : _	Holiday 12 _ : _ : _	Holiday 13 _ : _ : _	Holiday 14 _ : _ : _
[692]	Holiday 1 _ : _ : _	Holiday 2 _ : _ : _	Holiday 3 _ : _ : _	Holiday 4 _ : _ : _	Holiday 5 _ : _ : _	Holiday 6 _ : _ : _	Holiday 7 _ : _ : _
	Holiday 8 _ : _ : _	Holiday 9 _ : _ : _	Holiday 10 _ : _ : _	Holiday 11 _ : _ : _	Holiday 12 _ : _ : _	Holiday 13 _ : _ : _	Holiday 14 _ : _ : _
[693]	Holiday 1 _ : _ : _	Holiday 2 _ : _ : _	Holiday 3 _ : _ : _	Holiday 4 _ : _ : _	Holiday 5 _ : _ : _	Holiday 6 _ : _ : _	Holiday 7 _ : _ : _
	Holiday 8 _ : _ : _	Holiday 9 _ : _ : _	Holiday 10 _ : _ : _	Holiday 11 _ : _ : _	Holiday 12 _ : _ : _	Holiday 13 _ : _ : _	Holiday 14 _ : _ : _
[694]	Holiday 1 _ : _ : _	Holiday 2 _ : _ : _	Holiday 3 _ : _ : _	Holiday 4 _ : _ : _	Holiday 5 _ : _ : _	Holiday 6 _ : _ : _	Holiday 7 _ : _ : _
	Holiday 8 _ : _ : _	Holiday 9 _ : _ : _	Holiday 10 _ : _ : _	Holiday 11 _ : _ : _	Holiday 12 _ : _ : _	Holiday 13 _ : _ : _	Holiday 14 _ : _ : _

[695]	Holiday 1	Holiday 2	Holiday 3	Holiday 4	Holiday 5	Holiday 6	Holiday 7
	Holiday 8	Holiday 9	Holiday 10	Holiday 11	Holiday 12	Holiday 13	Holiday 14
[696]	Holiday 1	Holiday 2	Holiday 3	Holiday 4	Holiday 5	Holiday 6	Holiday 7
	Holiday 8	Holiday 9	Holiday 10	Holiday 11	Holiday 12	Holiday 13	Holiday 14
[697]	Holiday 1	Holiday 2	Holiday 3	Holiday 4	Holiday 5	Holiday 6	Holiday 7
	Holiday 8	Holiday 9	Holiday 10	Holiday 11	Holiday 12	Holiday 13	Holiday 14
[698]	Holiday 1	Holiday 2	Holiday 3	Holiday 4	Holiday 5	Holiday 6	Holiday 7
	Holiday 8	Holiday 9	Holiday 10	Holiday 11	Holiday 12	Holiday 13	Holiday 14

INTERNATIONAL PROGRAMMING

[700] Automatic Clock Adjust

Default = 60 |_____| Valid Entries 01-99 Seconds

[701] First International Options

Opt	Def	ON	OFF
1	<input type="checkbox"/>	50 Hz AC	✓ <input type="checkbox"/> 60 Hz AC
2	<input type="checkbox"/>	Time Base - Internal Crystal	✓ <input type="checkbox"/> Time Base - AC Line
3	<input type="checkbox"/>	AC/DC Arming Inhibit Enabled	✓ <input type="checkbox"/> AC/DC Arming Inhibit Disabled
4	<input type="checkbox"/>	All System Tamper Require Installer Reset	✓ <input type="checkbox"/> All System Tamper Follow Restore
5	<input type="checkbox"/>	6-digit User Access Codes	✓ <input type="checkbox"/> 4-digit User Access Codes
6	<input type="checkbox"/>	Busy Tone Detection Enabled	✓ <input type="checkbox"/> Busy Tone Detection Disabled
7	<input type="checkbox"/>	High Current Battery Charge	✓ <input type="checkbox"/> Standard Current Battery Discharge
8	<input type="checkbox"/>	DLS/Audio has no priority	✓ <input type="checkbox"/> DLS/Audio has priority

[702] Second International Options

Opt	Def	ON	OFF
1	<input type="checkbox"/>	Pulse Dialing Make/Break Ratio is 33/67	✓ <input type="checkbox"/> Pulse Dialing Make/Break Ratio is 40/60
2	✓ <input type="checkbox"/>	Force Dialing Enabled	<input type="checkbox"/> Force Dialing Disabled
3	<input type="checkbox"/>	Land Line Test Transmission in Minutes	✓ <input type="checkbox"/> Land Line Test Transmission in Days
4	<input type="checkbox"/>	1600 Hz Handshake	✓ <input type="checkbox"/> Standard Handshake
5	<input type="checkbox"/>	ID Tone Enabled	✓ <input type="checkbox"/> ID Tone Disabled
6	<input type="checkbox"/>	2100 Hz ID Tone	✓ <input type="checkbox"/> 1300 Hz ID Tone
7	<input type="checkbox"/>	One Time 1-Hr User Enabled DLS Window	✓ <input type="checkbox"/> Full 6-Hr User Enabled DLS Window
8	<input type="checkbox"/>	Bell on FTC when Armed	✓ <input type="checkbox"/> FTC Trouble only when Armed

[703] Delay Between Dialing Attempts

Default = 003 |_____| Valid Entries 001-255 Seconds

Module Programming

[801] PC5400 Printer Module Programming

Refer to the PC5400 *Installation Manual* for installation and programming instructions.

[802] PC59xx VOX Module Programming

Refer to the PC59xx *Installation Manual* for installation and programming instructions.

[804] PC5132 Wireless Expansion Programming

Refer to the PC5132 *Installation Manual* for programming locations and instructions.

[805] PC5100 Programming

Refer to the PC5100 *Installation Manual* for programming locations and instructions.

[851] T-Link Programming

Refer to the T-Link *Installation Manual* for programming locations and instructions.

Special Installer Functions

[899] Template Programming

[900] Panel Version Displayed

[901] InstallerWalk Test Mode Enable/Disable

[902] Module Supervision Reset

[903] Module Supervision Field

[904] Wireless Module Placement Test

[905] - [909] For Future Use

[990] Installer Lockout Enable

[991] Installer Lockout Disable

[992] For Future Use

[993] Restore Alternate Communicator to Default Programming

[994] For Future Use

[995] Restore Escort5580 to Default Programming

[996] Restore PC5132 to Default Programming

[997] Restore PC5400 to Default Programming

[998] Restore PC59xx to Default Programming

[999] Restore Control Panel to Default Programming

For the Record

Customer: _____

Address: _____

Telephone: _____ Installation Date: _____

Installers Code: _____

Module Name	Description	Location
PC1616/PC1832/PC1864	Main Panel	_____
_____	_____	_____
_____	_____	_____
_____	_____	_____
_____	_____	_____
_____	_____	_____
_____	_____	_____
_____	_____	_____
_____	_____	_____

Keypads	Keypad Type	Location
Keypad 1	_____	_____
Keypad 2	_____	_____
Keypad 3	_____	_____
Keypad 4	_____	_____
Keypad 5	_____	_____
Keypad 6	_____	_____
Keypad 7	_____	_____
Keypad 8	_____	_____

Zone Programming Summary

Zone programming can be found in sections [001] - [004], [101] - [164], [020], [202]-[265]. Use this area to record a summary of your zone programming.

System Zone	Zone Label	Zone Type	System Zone	Zone Label	Zone Type
Zone 1			Zone 33		
Zone 2			Zone 34		
Zone 3			Zone 35		
Zone 4			Zone 36		
Zone 5			Zone 37		
Zone 6			Zone 38		
Zone 7			Zone 39		
Zone 8			Zone 40		
Zone 9			Zone 41		
Zone 10			Zone 42		
Zone 11			Zone 43		
Zone 12			Zone 44		
Zone 13			Zone 45		
Zone 14			Zone 46		
Zone 15			Zone 47		
Zone 16			Zone 48		
Zone 17			Zone 49		
Zone 18			Zone 50		
Zone 19			Zone 51		
Zone 20			Zone 52		
Zone 21			Zone 53		
Zone 22			Zone 54		
Zone 23			Zone 55		
Zone 24			Zone 56		
Zone 25			Zone 57		
Zone 26			Zone 58		
Zone 27			Zone 59		
Zone 28			Zone 60		
Zone 29			Zone 61		
Zone 30			Zone 62		
Zone 31			Zone 63		
Zone 32			Zone 64		

Appendix A: Reporting Codes

The following tables contain Contact ID and Automatic SIA format reporting codes. For more information on reporting code formats and notes about individual reporting codes, (see *Section 5.6 Communicator Programming PWS Sect 6*).

Contact ID

The first digit (in parentheses) will automatically be sent by the control. The second two digits are programmed to indicate specific information about the signal. For example, if zone 1 is an entry/exit point, you could program the event code as [34]. The central station would receive the following:

*BURG - ENTRY/EXIT - 1 where the "1" indicates which zone went into alarm.

SIA Format - Level 2 (Hardcoded)

The SIA communication format used in this product follows the level 2 specifications of the SIA Digital Communication Standard - October 1997. This format will send the Account Code along with its data transmission. The transmission will look similar to the following at the receiver:

```
N Ri01    BA 01
N        = New Event
Ri01    = Partition /Area Identifier
BA      = Burglary Alarm
01      = Zone 1
```

NOTE: A system event will use the Area Identifier Ri00.

Section #	Reporting Code	Code Sent When...	Dialer Direction*	Automatic Contact ID Codes	SIA Auto Rep Codes**
[320]-[323]	Zone Alarms	Zone goes into alarm	A/R	See Table 3	See Table 3
[324]-[327]	Zone Restorals	Alarm condition has been restored	A/R		
[328]	Duress Alarm	Duress code entered at keypad	A/R	(1) 21	HA-00
[328]	Opening After Alarm	System disarmed with alarm in memory	A/R	(4) 58	OR-UU
[328]	Recent Closing	Alarm occurs within two minutes of system arming	A/R	(4) 59	CR-00
[328]	Zone Expander Supervisory Alarm/Rest.	Panel loses/restores supervisory transmission over the Keybus from zone expansion modules, or keypads with zone inputs	A/R	(1) 43	UA-00/UH-00
[328]	Cross Zone (Police Code) Alarm	Two zones on the same partition go into alarm during any given armed-to-armed period (incl. 24Hr zones)	A/R	(1) 39	BM-00/BV-00
[328]	Burglary Not Verified		A/R	(3) 78	BG-00
[328]	Alarm Cancelled		A/R	(4) A6	BC-00
[329]	[F] Key Alarm/Rest.	Keypad fire alarm (alarm and restore rep. codes sent together)	A/R	(1) 1A	FA-00/FH-00
[329]	[A] Key Alarm/Rest.	Keypad auxiliary alarm (alarm and restore rep. codes sent together)	A/R	(1) AA	MA-00/MH-00
[329]	[P] Key Alarm/Rest.	Keypad panic alarm (alarm and restore rep. codes sent together)	A/R	(1) 2A	PA-00/PH-00
[329]	Aux Input Alarm/Rest	Option#23/24: a panic button wired to PGM 2 is pressed/access code is entered Option #04: a 2-wire smoke detector wired to PGM 2 goes into alarm/alarm is cleared.	A/R	(1) 4A	UA-99/UH-99
			A/R	(1) 11	FA-99/FH-99
[330]-[337]	Zone Tamper/Restoral	Zone is tampered / tamper condition restored	T/R	(3) 83	TA-ZZ/TR-ZZ
[338]	General System Tamper/Rest.	Enrolled module with tamper inputs has a tamper alarm/all module tampers restored	T/R	(1) 45	ES-00/EJ-00
[338]	Keypad Lockout	Maximum number of incorrect access codes has been entered at a keypad	T/R	(4) 61	JA-00
[339-341]	Closings	System armed (user 01-32 indicated)	O/C	(4) A1	CL-UU
[341]	Partial Closing	One or more zones bypassed when system armed	O/C	(4) 56	CG-ZZ
[341]	Special Closing	Closing (arming) using one of the following methods: quick arm, auto arm, keyswitch, function key, maintenance code, DLS software, wireless key	O/C	(4) AA	CL-00
[341]	Late to Close	Whenever the Auto-arm prealert sounds (if the Late to Close option is enabled)	O/C	(4) 54	CI-00
[341]	Exit Fault		O/C	(3) 74	EE-00
[342-344]	Openings	System disarmed (user 01-32 indicated)	O/C	(4) A1	OP-UU
[344]	Auto-arm Cancellation	Auto-arm cancelled	O/C	(4) 55	CI-00
[344]	Special Opening	Opening (disarming) using one of the following methods: key-switch, maintenance code, DLS software, wireless key	O/C	(4) AA	OP-00
[345]-[346]	Battery Trouble/Rest.	PC1616/PC1832/PC1864 battery is low/battery restored	MA/R	(3) A2	YT-00/YR-00
[345]-[346]	AC Line Trouble/Rest.	AC power to control panel is disconnected or interrupted/AC power restored (Both codes follow AC Failure Comm. Delay.)	MA/R	(3) A1	AT-00/AR-00
[345]-[346]	Bell Circuit Trouble/Rest.	Open or short circuit detected across bell terminals/bell circuit restored	MA/R	(3) 21	YA-99/YH-99
[345]-[346]	Fire Trouble/Rest.	Trouble occurs/restores on a fire zone	MA/R	(3) 73	FT-99/FJ-99

Section #	Reporting Code	Code Sent When...	Dialer Direction*	Automatic Contact ID Codes	SIA Auto Rep Codes**
[345]-[346]	Auxiliary Power Trouble/ Rest.	Aux voltage supply trouble/restoral	MA/R	(3) 12	YP-00/YQ-00
[345]	TLM Failure	Telephone line monitoring trouble	MA/R	(3) 51	LT-01
[346]	TLM Restore	Telephone line restored	MA/R	(3) 51	LR-01
[345]-[346]	Gen System Trouble/Rest.	"Service Required" trouble occurs (view troubles using [*][2])/trouble restored	MA/R	(3) AA	YX-00/YZ-00
[345]-[346]	Gen System Supervisory Trouble/Rest.	Control panel loses/restores communications with module(s) connected to the Keybus	MA/R	(3) 3A	ET-00/ER-00
[347]	Phone# 1 or 2 FTC Restoral	Control panel has restored communications to central station on Phone# 1 or 2 (after FTC)	MA/R	(3) 54	YK-00
[347]	Event Buffer is 75% Full	Event buffer is almost full since last upload	MA/R	(6) 22	JL-00
[347]	DLS Lead In	Downloading session start	MA/R	(4) 11	RB-00
[347]	DLS Lead Out	Downloading session complete	MA/R	(4) 12	RS-00
[347]	Zone Fault/Rest.	One or more zones have faults/restored	MA/R	(3) 80	UT-ZZ/UJ-ZZ
[347]	Delinquency	Programmed amount of time (days or hours) for delinquency has expired without zone activity, or without system being armed	MA/R	(6) 54***	CD-00
[347]	Wireless Device Low Battery Trouble/Rest.	Wireless zones, panic pendants, handheld keypads, wireless keys have low battery/all low batteries restored	MA/R	(3) 84	XT-00/XR-00 XT-ZZ/XR-ZZ****
[347]	Installer Lead In	Installer's mode has been entered	MA/R	(6)27	LB-00
[347]	Installer Lead Out	Installer's mode has been exited	MA/R	(6)28	LS-00
[348]	Walk Test End	End of test	T	(6) A7	TE-00
[348]	Walk Test Begin	Beginning of test	T	(6) A7	TS-00
[348]	Periodic Test with Trouble	Periodic system test transmission with trouble	T	(6) A8	RY-00
[348]	Periodic Test	Periodic system test transmission	T	(6) A2	RP-00
[348]	System Test	[*][6] bell/communications test	T	(6) A1	RX-00
[349]	PC5700 Ground Fault Trouble/Restore	Ground/Fault/Trouble occurs on the PC5700	MA/R	(3) 1A	US-00/UR-00
[349]	PC5700 TLM Line 1 Trouble/Restore	TLM Trouble /Restore occurs on the PC5700	MA/R	(3) 51	LT-01/LR-01
[349]	PC5700 TLM Line 2 Trouble/Restore	TLM Trouble /Restore occurs on the PC5700	MA/R	(3) 52	LT-02/LR-02
[601]-[604]	Closings	System armed (user 33-95 indicated)	O/C	(4) A1	CL-UU
[605]-[608]	Openings	System disarmed (user 33-95 indicated)	O/C	(4) A1	OP-UU

* A/R = alarms/restorals; T/R = tampers/restorals; O/C = openings/closings; MA/R = miscellaneous alarms/restorals; T = test transmissions
 ** UU = user number (user01-42); ZZ = zone number (01-64)
 *** Use the "Fail to close" event code [(4)54] to report closing or activity delinquency. Ensure the central station is aware that this code is used.
 **** Zones are identified, panic pendants, wireless keys, and handheld keypads are not.

Contact ID Zone Alarm/Restoral Event Codes

(as per SIA DCS: 'Contact ID' 01-1999):
 Program any of these codes for zone alarms/restorals when using the standard (non-automatic) Contact ID reporting format.

Medical Alarms	(1)34 Entry / Exit
(1)AA Medical	(1)35 Day / Night
(1)A1 Pendant Transmitter	(1)36 Outdoor
(1)A2 Fail to Report In	(1)37 Tamper
Fire Alarms	(1)38 Near Alarm
(1)1A Fire Alarm	General Alarms
(1)11 Smoke	(1)4A General Alarm
(1)12 Combustion	(1)43 Exp. module failure
(1)13 Water Flow	(1)44 Sensor tamper
(1)14 Heat	(1)45 Module Tamper
(1)15 Pull Station	(1)4A Cross Zone Police Code
(1)16 Duct	24 Hour Non-Burglary
(1)17 Flame	(1)5A 24 Hour non-Burg
(1)18 Near Alarm	(1)51 Gas detected
Panic Alarms	(1)52 Refrigeration
(1)2A Panic	(1)53 Loss of Heat
(1)21 Duress	(1)54 Water Leakage
(1)22 Silent	(1)55 Foil Break
(1)23 Audible	(1)56 Day Trouble
Burglar Alarms	(1)57 Low bottled Gas level
(1)3A Burglary	(1)58 High Temp
(1)31 Perimeter	(1)59 Low Temp
(1)32 Interior	(1)61 Loss of Air Flow
(1)33 24 Hour	

SIA Format Automatic Zone Alarm/Restoral Codes

Zone Definition	SIA Auto Rep Codes*	Contact ID Auto Rep Codes*
Delay 1	BA-ZZ/BH-ZZ	(1) 3A
Delay 2	BA-ZZ/BH-ZZ	(1) 3A
Instant	BA-ZZ/BH-ZZ	(1) 3A
Interior	BA-ZZ/BH-ZZ	(1) 3A
Interior Stay/Away	BA-ZZ/BH-ZZ	(1) 3A
Delay Stay/Away	BA-ZZ/BH-ZZ	(1) 3A
Delayed 24-Hr Fire	FA-ZZ/FH-ZZ	(1) 1A
Standard 24-Hr Fire	FA-ZZ/FH-ZZ	(1) 1A
24-Hr Supervisory	US-ZZ/UR-ZZ	(1) 5A
24-Hr Supervisory Buzzer	UA-ZZ/UH-ZZ	(1) 5A
24-Hr Burg	BA-ZZ/BH-ZZ	(1) 3A
24-Hr Holdup	HA-ZZ/HH-ZZ	(1) 22
24-Hr Gas	GA-ZZ/GH-ZZ	(1) 51
24-Hr Heat	KA-ZZ/KH-ZZ	(1) 58
24-Hr Medical	MA-ZZ/MH-ZZ	(1) AA
24-Hr Panic	PA-ZZ/PH-ZZ	(1) 2A
24-Hr Emergency (non-medical)	QA-ZZ/QH-ZZ	(1) A1
24-Hr Sprinkler	SA-ZZ/SH-ZZ	(1) 13
24-Hr Water	WA-ZZ/WH-ZZ	(1) 54
24-Hr Freeze	ZA-ZZ/ZH-ZZ	(1) 59
24-Hr Latching	UA-ZZ/UH-ZZ	(1) 4A
Interior Delay	BA-ZZ/BH-ZZ	(1) 3A
Auto Verified Fire	FA-ZZ/FH-ZZ	(1) 1A
24-Hr Fire Supervisory	FS-ZZ/FV-ZZ	(2) AA
Day Zone	BA-ZZ/BH-ZZ	(1) 3A
Instant Stay/Away	BA-ZZ/BH-ZZ	(1) 3A
24-Hr Bell/Buzzer	UA-ZZ/UH-ZZ	(1) 5A
24-Hr Non-latching Tamper	UA-ZZ/UH-ZZ	(1) 4A
Night Zone	BA-ZZ/BH-ZZ	(1) 3A
Delayed 24-Hr Fire (Wireless)	FA-ZZ/FH-ZZ	(1) 1A
Standard 24-Hr Fire (Wireless)	FA-ZZ/FH-ZZ	(1) 1A

* ZZ = zones 01-64

Appendix B: UL Listed Commercial and Residential Installations

The installation requirements listed below must be met for the following grades of service.

Central Station and Police Connect (Standard or Encrypted Line Security Service)

The installation must use T-Link module which communicates over LAN/WAN to the Sur-Gard MLR-IP receiver or the TL200/250 which communicates over LAN/WAN/Internet to the SG System III receiver. Polling time must be 90 seconds. Compromise detection time must be 6 minutes.

Local

- The installation must have a bell which is UL Listed for mercantile local alarms (AMSECO MBL10B with model AB-12 bell housing).
- The digital communicator must be enabled.
- The control panel must be in the attack-resistant enclosure (DSC Model CMC-1 or PC4050CAR).

Central Station and Police Connect (No line security)

- The installation must have a bell which is UL Listed for mercantile local alarms (AMSECO MBL10B with model AB-12 bell housing).
- The digital communicator must be enabled.
- The control panel must be in the attack resistant enclosure (DSC Model CMC-1 or PC4050CAR).

All Commercial Installations

- The Entry Delay must not exceed 120 seconds.
- The Exit Delay must not exceed 120 seconds.
- The minimum Bell Time-out is 15 minutes.

Residential Fire & Burglary Installations

- The Entry Delay must not exceed 45 seconds.
- The Exit Delay must not exceed 60 seconds.
- The minimum Bell Time-out is 4 minutes.

Home Health Care Signaling Equipment

- There must be at least two keypads, one of either the LCD5500Z/LCD5520Z or LCD5501Z and one of the following models, PC5508Z, PC5516Z or PC5532Z.
- Each system shall be programmed to activate an audible Trouble signal within 90 seconds upon loss of microprocessor memory.
- The minimum Bell Time-out is 5 minutes.

Programming

The notes in the programming sections describing the system configurations for UL Listed installations must be implemented.

Control of the Protected Premises

In order to have a UL Certificated system the protected area is to be under the responsibility of one ownership and management (i.e., one business under one name). This may be a group of buildings attached or unattached with different addresses but under the responsibility of someone having mutual interest. The person of mutual interest is not the alarm-installing company.

Bell Location

The alarm sounding device (bell) must be located where it can be heard by the person or persons responsible for maintaining the security system during the daily arming cycle.

Protection of the Control Unit

The local control and the local power supply must be protected in one of the following ways:

- The control unit and audible alarm device must be in a protected area which is armed 24 hours a day.
- Each partition must arm the area protecting the control unit and the audible alarm device power supply. This may require duplicate protection armed by each partition. Access to this protected area, without causing an alarm, will require that all partitions be disarmed.
- In all cases described above, the protected area for the control unit must be programmed as not-bypassable.

Casual Users

The installer should caution the user(s) not to give system information to casual users (e.g. codes, bypass methods, etc. to baby-sitters or service people). Only the One-Time Use codes should be given to casual users.

User Information

The installer should advise the users and note in the User's Manual:

- Service organization name and telephone number
- The programmed exit time
- The programmed entry time
- Test system weekly

Two-Wire Smoke Detector Compatibility (if available)

Maximum loop resistance: 24 Ohms

- Operating Voltage Range: 9.8 - 13.8 VDC
- Maximum Alarm Current: 89 mA
- Compatibility Identifier: PC18-1

See **Section 1.6 PGM Wiring** for compatible 2-wire smoke detectors.

SIA FAR Installations

Minimum requirement system for SIA-FAR Installations:

- **1 PC1616/PC1832/PC1864 Control panel**
- **2 Local annunciation devices**

The local annunciation devices may be any combination of the following keypads:

- | | | | |
|------------|------------|----------|----------|
| • LCD5500Z | • LCD5501Z | • PK5500 | • PK5508 |
| • PKP-LCD | • PKP-ICN | • PK5501 | • PK5516 |

The following optional subassembly modules also bear the SIA FAR classification and may be used if desired:

PC5108 Zone Expander Module

Compatible initiating devices: Bravo200 series, 300 series, 400 series, 500 series, 600 series, AC-100, Encore300 series, Force200 series, 210 series, MN240.

PC5208 Low Current PGM Output Module

The following optional accessory modules also bear the SIA FAR classification and may be used if desired.

PC5204 Auxiliary Power Supply with PGM output ports Escort5580/Escort5580TC, PC5400 Printer Module

Caution

- For SIA FAR installations, only use modules / devices that are listed on this page.
- Fire Alarm Verification feature (Auto Verified Fire zone) is not supported on 2-wire smoke detectors zones. This feature may be enabled for 4-wire smoke detectors only.
- Call Waiting Cancel (Section 382 Option 4) feature on a non-Call Waiting line will prevent successful communication to the central station.
- All smoke detectors on the system must be tested annually by conducting the Installer Walk Test prior to exiting the walk test mode, a sensor reset must be conducted on the system, **[*][7][2]** to reset all latching 4-wire smoke detectors. Please refer to the smoke detector installation instructions on how to correctly test the detectors.

Notes

- Programming at installation may be subordinate to other UL requirements for the intended application.
- Cross zones have the ability to individually protect the intended area (e.g., motion detectors, which overlap).
- Cross zoning is not recommended for line security Installations nor is it to be implemented on exit / entry zones.
- There is a communication delay of 30 seconds in this control panel. It can be removed, or it can be increased up to 45 seconds at the option of the end user by consulting with the Installer.
- Do not duplicate any reporting codes. This applies for all communication formats other than SIA sending automatic programmed reporting codes.
- The control unit must be installed with a local sounding device and an off-premise transmission for SIA communication format.
- For ULC Listed Fire Monitoring Installations & module requirements, Refer to the ULC Installation Information sheet, part# 29002157.
- Use a CSA/cUL transformer, hardwired.
- All tamper circuits may be connected to the same zone.
- Use ULC-LA for AC Power indication.

Appendix C: SIA False Alarm Reduction

SIA Feature Programming Section	Comments	Range/Default	Requirement
Exit Time [005], 3rd entry	Access to Entry and Exit delays for each partition and Bell Time Out for the system	For Full or auto arming: Range: 45- 255 seconds Default: 60 sec.	Required (programmable)
Progress Annunciation/Disable - for Silent Exit [014], Option 6 ON	Enables audible exit beeps from the keypad for the duration of exit delay	Individual keypads may be disabled Default: All Enabled	Allowed
Exit Time Restart [018], Option 7 ON	Enables the exit delay restart feature	Default: Enabled	Required
Auto Stay Arm on Unvacated Premises [001]-[004] Zone type 05, 06	Function Key: Stay Arming. All Stay/Away type zones (05, 06) will be automatically bypassed	If no exit after full arm Default: Enabled	Required
Exit Time and Progress Annunciation/Disable or Remote Arming [005] and [014] bit 6	System Times and Audible Exit beeps can be disabled when using the Key fob to arm away the system	Default: Enabled	Allowed
Entry delay(s) [005], 1st and 2nd entry	Access to Entry and Exit delays for each partition and Bell Time Out for the system Note: Combined Entry delay and Communications Delay (Abort Window) shall not exceed 60s	Range: 30 sec. to 4 min. Default: 30 sees	Required (programmable)
Abort Window for Non-Fire zones [101]-[164] bit 7 ON	Access to zone attributes, i.e. swinger shutdown, transmission delay and cross zone. Individual zones attribute bit 7 (Transmission delay) is by default ON	May be disabled by zone or zone type Default: Enabled	Required
Abort Window - for Non-Fire zones [377], 4th entry	Access to the programmable delay before communicating alarms Note: Combined Entry delay and Communications Delay (Abort Window) shall not exceed 60s	Range: 15 - 45 sec. Default: 30 sees	Required (programmable)
Abort Annunciation [382], Option 3 ON	Enables the "Communication Cancelled" message display on all keypads	Annunciate that no alarm was transmitted Default: Enabled	Required
Cancel Annunciation [328], 8th entry	Access to the reporting code for Alarm Cancelled	Annunciate that a Cancel was transmitted Default: Enabled	Required
Duress Feature [*][5] Master Code [99] Option 2 ON	Do not derive code from an existing Master/User code (e.g., Master code is 1234, the duress code should not be 1233 or 1235)	No 1+/- derivative of another user code. No duplicates with other user codes Default: disabled	Allowed
Cross Zoning [018] Option 6 [101]-[164] bit 9 OFF	This option enables Cross Zoning for entire system. Individual zones can be enabled for Cross zoning via Zone attribute bit 9 in sections [101] - [164]	Programming required Default: Disabled	Required
Cross Zone Timer [176]	Access to the programmable Cross Zone timer	May program Range: 001-255 sec./min. Default: 60 secs	Allowed
Swinger Shutdown for Alarms [377] 1st entry	Access to the swinger shutdown limit for zone alarms	For all non-fire zones shut down at 1 or 2 trips Default: 1 Trip	Required (programmable)
Swinger Shutdown Disable [101] - [164] bit 6 ON	Access to zone attributes, i.e., swinger shutdown, transmission delay and cross zone. Individual zones attribute bit 6 (Swinger shutdown enabled) is by default ON	For non-police response zones Default: Enabled	Allowed
Fire Alarm Verification Zone type [29]	Auto Verified Fire, use only with 4 wire type detectors that can be reset by the panel 4-wire smoke detector powered from AUX + and PGM1 - PGM4 (type 03, Sensor reset)	70 seconds reset and confirmation time Default: disabled	Required
Call Waiting Cancel Dial String [304], [382], Option 4 OFF	Access to the dialing sequence used to disable call waiting	Dependant on user phone line Default: disabled	Required

Testing

System Test: [*][6] Master Code, Option 4	The system activates all keypad sounders, bells or sirens for 2 seconds and all keypad lights turn on. Refer to the <i>User Manual (part no. 29007165)</i> .
Installer Walk Test Mode: [901]	This mode is used to test each zone on the system for proper functionality.
Alarm Communications During Walk Test [382] Option 2:	Enables Communication of zone alarms while installer Walk Test is active.
Walk Test End and Begin Reporting Codes [348], 1 st and 2 nd Entries	Access to the reporting codes for Walk Test Begin and Walk Test End.

Appendix D: Troubleshooting Guide

Testing:

- Power up system
- Program options as required (See *Programming Section*)

NOTE: For advanced programming refer to the *PC1616/1832/1864 Reference Manual*

- Violate, then restore zones
- Verify correct **Reporting Codes** are sent to the Central Station

Troubleshooting:

LCD Programmable-Message Keypad

- Press **[*][2]** to view a trouble condition.
- The trouble light will flash and the LCD will display the first trouble condition present.
- Use the arrow keys to scroll through all trouble conditions present.

NOTE: When additional information is available for a specific trouble condition a **[*]** will appear on the display. Press the **[*]** key to view the additional information

LED Keypads, LCD Fixed Message Keypads

- Press **[*][2]** to view a trouble condition.
- The trouble light will flash.
- Refer to the **Trouble Summary** chart below to determine the trouble condition(s) present.

Trouble Summary:

Light [1]* Service Required - Press [1] for more information

- [1] Low Battery
- [2] Bell Circuit
- [3] General System Trouble
- [4] General system Tamper
- [5] Module Supervision
- [6] RF Jam Detected
- [7] PC5204 Low Battery
- [8] PC5204 AC Failure

Light [2] AC Trouble

Light [3] Telephone Line Trouble

Light [4] Failure to Communicate

Light [5]* Zone Fault -Press [5] for more information

Light [6]* Zone Tamper - Press [6] for more information

Light [7]* Wireless Device Low Battery - Press [7] for more information

Light [8] Loss of Time or Date

Trouble	Cause	Troubleshooting
<p>Trouble [1] Service Required Press [1] to determine specific trouble</p>		
<p>[1] Low Battery</p>	<p>Main panel battery less than 11.1VDC</p> <p>NOTE: This trouble condition will not clear until the battery voltage is 12.5VDC min., under load.</p>	<p>NOTE: If battery is new allow 1 Hr. for battery to charge.</p> <ul style="list-style-type: none"> • Verify voltage measured across AC terminals is 16-18 VAC. Replace transformer if required. • Disconnect battery wire leads <ul style="list-style-type: none"> • Verify battery charging voltage measured across battery leads = 13.70 - 13.80 VDC. • Connect battery, remove AC power <ul style="list-style-type: none"> • Verify measured voltage across battery terminals is 12.5VDC min.
<p>[2] Bell Circuit</p>	<p>Bell+, Bell-...Open Circuit</p>	<ul style="list-style-type: none"> • Disconnect Bell-/Bell+ wire leads, measure resistance of wire leads. <ul style="list-style-type: none"> • Open circuit indicates break in wiring or defective siren/bell • Jumper Bell+, Bell- with 1K resistor (Brown, Black, Red) <ul style="list-style-type: none"> • Verify trouble clears
<p>[3] General System Trouble</p>	<p>PC5204 Output#1 Open Circuit</p>	<ul style="list-style-type: none"> • If Output#1 is unused: Ensure that terminals O1, AUX are jumpered with 1K resistor (Brown, Black, Red) • If Output #1 is used: Disconnect wire leads from O1, AUX terminals, measure the resistance of the wire leads <ul style="list-style-type: none"> • Open circuit indicates a break in the wiring
	<p>PC5204 AUX</p>	<ul style="list-style-type: none"> • Verify voltage measured across AC input terminals is 16-18VAC. • Disconnect all connections to PC5204 AUX terminal. <ul style="list-style-type: none"> • Verify AUX voltage is 13.70 - 13.80 VDC.
	<p>Printer connected to PC5400 offline</p>	<p>Verify printer operation (out of paper, paper jam etc.)</p>
	<p>T-Link Network Fault present T-Link Receiver Trouble present T-Link Interface Trouble present</p>	<p>Refer to the T-Link TL150/250/350 Installation Manual for details.</p>
<p>[4] General System Tamper</p>	<p>Tamper input on module(s) open circuit</p>	<p>Short tamper terminal to COM terminal on unused modules connected to KEYBUS (PC5100, PC5108, PC5200, PC5204, PC5208, PC5320, PC5400, PC5700).</p>
<p>[5] Module Supervision</p>	<p>Panel does not communicate with module(s) on KEYBUS</p> <p>Keypad assigned to incorrect slot.</p>	<p>Modules are immediately enrolled and supervised when detected on the KEYBUS. If a module has been removed, or if the slot assignment of a keypad has been changed, module supervision must be reset.</p> <ul style="list-style-type: none"> • View the event buffer (via DLS or LCD5500 keypad) to identify the specific module(s) in trouble • To reset module supervision: <ul style="list-style-type: none"> • Enter Program Section [902]. • Press [#] (wait 1 minute for panel to scan KEYBUS). • Enter Program Section [903] to identify modules connected to the KEYBUS.
<p>[6] RF Jam Detected</p>	<p>Wireless Receiver - excessive noise detected.</p>	<p>Check for external 433MHZ signal sources</p> <p>To disable RF Jam: enable Option [7] in program section [804] subsection [90].</p>
<p>[7] PC5204 Low Battery</p>	<p>PC5204 battery less than 11.5VDC</p> <p>NOTE: This trouble condition will not clear until the battery voltage is 12.5VDC min., under load.</p>	<p>See [1] Low Battery above</p>
<p>[8] PC5204 AC Failure</p>	<p>No AC at PC5204 AC inputs</p>	<p>Verify voltage measured across AC terminals is 16-18VAC. Replace transformer if required.</p>

Trouble	Cause	Troubleshooting
Trouble [2] AC Failure		
	No AC at panel AC input terminals	Verify voltage measured across AC terminals is 16-18VAC. Replace transformer if required.
Trouble [3] Telephone Line Trouble		
	Phone Line Voltage at TIP, RING on main panel less than 3VDC	<ul style="list-style-type: none"> • Measure the voltage across TIP and RING on the panel: <ul style="list-style-type: none"> • No phone off-hook – 50VDC (approx) • Any phone off-hook – 5VDC (approx) • Wire incoming line directly to TIP and RING. • If trouble clears, check wiring or the RJ-31 phone jack.
Trouble [4] Failure to Communicate		
	Panel fails to communicate one or more events to central station	<p>Connect a headset to TIP and RING of the control panel. Monitor for the following conditions:</p> <ul style="list-style-type: none"> • Continuous dial tone <ul style="list-style-type: none"> • Reverse TIP and RING • Recorded operator message comes on <ul style="list-style-type: none"> • Verify correct phone number is programmed • Dial the number programmed using a regular telephone to determine if a [9] must be dialed or if 800 service is blocked. • Panel does not respond to handshakes. <ul style="list-style-type: none"> • Verify the format programmed is supported by the central station. • Panel transmits data multiple times without receiving a handshake <ul style="list-style-type: none"> • Verify that the account number and reporting codes are correctly programmed. <p>NOTE:</p> <p>Contact ID and Pulse formats</p> <ul style="list-style-type: none"> • Program a HEX [A] to transmit a digit [0] <p>SIA format</p> <ul style="list-style-type: none"> • Program a digit [0] to transmit a digit [0]
Trouble [5] Zone Fault Press [5] to determine specific zones with a fault trouble		
	Open circuit is present on one or more fire zones on the main panel or zone expander	<ul style="list-style-type: none"> • Ensure fire zones have a 5.6K resistor (Green, Blue, Red) connected. • Remove the wire leads from Z and COM terminals and measure the resistance of the wire leads. <ul style="list-style-type: none"> • An open circuit indicates a break in the wiring or resistor not connected. • Connect a 5.6K resistor (Green, Blue, Red) across the Z and COM terminals. Verify the trouble condition clears.
	An open circuit is present on PGM2 being used as a 2-wire smoke detector input	<ul style="list-style-type: none"> • Ensure the correct 2.2K end-of-line resistor is connected (Red, Red, Red). • Remove the wire leads from PGM2 and AUX+ terminals and measure the resistance of the wire leads. <ul style="list-style-type: none"> • An open circuit indicates a break in the wiring or no resistor connected. • Connect a 2.2K resistor (Red, Red, Red) across the PGM2 and AUX+ terminals. Verify the trouble condition clears.

Trouble	Cause	Troubleshooting
---------	-------	-----------------

Trouble [5] Zone Fault (Cont.)

	One or more wireless devices have not checked in within the programmed time	<ul style="list-style-type: none"> • If the trouble occurs immediately, a conflict with a hard wired zone exists: <ul style="list-style-type: none"> • The zone being used is already assigned to a PC5108 zone expander • The zone being used is assigned as a keypad zone • Perform a Module Placement Test – Program Section [904] and verify the wireless device is in a good location. <ul style="list-style-type: none"> • If bad test results occur, test the wireless device in another location • If the wireless device now tests good, the original mounting location is bad • If the wireless device continues to give bad test results replace the wireless device
	A short circuit is present on one or more zones with double end-of-line resistors enabled	<ul style="list-style-type: none"> • Remove the wire leads from Z and COM terminals and measure the resistance of the wire leads. <ul style="list-style-type: none"> • A short circuit indicates a short in the wiring. • Connect a 5.6K resistor (Green, Blue, Red) across the Z and COM terminals. <ul style="list-style-type: none"> • Verify the trouble condition clears.

Trouble [6] Zone Tamper

Press [6] to determine specific zones with a tamper trouble

	A tamper condition is present on one or more wireless devices	<ul style="list-style-type: none"> • Perform a Module Placement Test –Section [904] • Violate, then restore the tamper: <ul style="list-style-type: none"> • If no test result then replace wireless device
	An open circuit is present on one or more zones with double end-of-line resistors enabled	<ul style="list-style-type: none"> • Remove the wire leads from Z and COM terminals. • Measure the resistance of the wire leads. <ul style="list-style-type: none"> • Open circuit indicates a break in the wiring. • Connect a 5.6K resistor (Green, Blue, Red) across the Z and COM terminals. <ul style="list-style-type: none"> • Verify the trouble condition clears.

Trouble [7] Wireless Device Low Battery

Press [7] to toggle through specific devices with low battery trouble

<p>1st press – Wireless Zones</p> <p>2nd press – Handheld Keypads</p> <p>3rd press – Wireless Keys</p>	<p>One or more wireless devices has a low battery</p> <p>NOTE: The event will not be logged to the event buffer until the wireless device low battery delay time expires</p> <ul style="list-style-type: none"> • Program Section [377] Opt 9 	<p>Replace battery</p> <p>NOTE: Replacing batteries will cause a tamper. Replacing cover will restore the tamper causing the associated reporting codes to be sent to the Central Station.</p>
---	---	---

Trouble [8] Loss of Clock/Date

	The main panel internal clock is not set	<p>To program the time and date:</p> <ul style="list-style-type: none"> • Enter [*][6][Master Code] then Press [1] • Enter the time and date (in military) using the following format: HH:MM MM/DD/YY <p>Example. For 6:00 pm, June 29, 2005 Enter: [18] [00] [06] [29] [05]</p>
--	--	--

IMPORTANT!

Ensure you have the following information available before contacting Customer Support

- Control Panel Type and Version, (e.g., PC1864 v4.1)

***NOTE:** Version number can be accessed by entering [*][Installer Code][900] on any LCD keypad. This information is also located on a sticker on the Printed Circuit Board.*

- List of modules connected to Control Panel, (e.g., PC5400, PC5204 etc.)

Appendix E: Template Programming

Template programming allows quick programming of the minimum functions required for basic operation. The below tables are used to determine the desired template to be used (for information on performing template programming see **Section 4 – Programming Descriptions**). Each digit represents 1 of the template sections listed below. The option number selected for each digit will make up the 5 digit template programming code.

- **Digit 1** selects Zone 1-8 definition options.

Option	Zn1	Zn2	Zn3	Zn4	Zn5	Zn6	Zn7	Zn8
1	1	3	3	3	4	4	4	4
2	1	3	3	5	5	5	5	8
3	1	3	3	5	5	5	5	7
4	1	1	3	3	3	3	3	3
5	1	3	3	6	5	5	5	5
6	1	3	3	6	5	5	5	8
Refer to Section 4 for Zone definition details								

1 Delay 1
2 Delay 2
3 Instant
4 Interior
5 Interior Stay/Away
6 Delayed Stay/Away
7 Delayed 24-Hour Fire
8 Standard 24-Hour Fire

- **Digit 2** selects system EOL configuration options.

Option		[013] Opt 1	[013] Opt 2
1	NC loops	ON	OFF
2	SEOL	OFF	OFF
3	DEOL	OFF	ON

- **Digit 3** selects panel communications options.

Op#	Phone Line 1	Programming Section	Phone Line 2	Programming Section
1	Disabled	[380] Opt 1 OFF	Disabled	[380] Opt 1 OFF
2	SIA automatic Reporting Codes enabled	[350] 1st Phone # [04] [380] Opt 1 ON [381] Opt 3 OFF	SIA automatic Reporting Codes enabled	[350] 2nd Phone # [XX]
3	Contact ID Reporting Codes enabled	[350] 1st Phone # [03] [380] Opt 1 ON [381] Opt 7 OFF	SIA automatic Reporting Codes enabled	[350] 2nd Phone # [XX]
4	SIA automatic Reporting Codes enabled	[350] 1st Phone # [04] [380] Opt 1 ON [381] Opt 3 OFF	Residential Dial Enabled	[350] 2nd Phone # [06]
5	Contact ID Reporting Codes enabled	[350] 1st Phone # [03] [380] Opt 1 ON Opt 7 OFF	Residential Dial Enabled	[350] 2nd Phone # [06]
6	Contact ID Reporting Codes enabled	[350] 1st Phone # [03] [380] Opt 1 ON [381] Opt 7 OFF	Contact ID Reporting Codes Enabled	[350] 2nd Phone # [03]

- Digit 4 selects reporting code configurations

Option	Common Group	Selected Troubles	Openings/Closings	Zone Restorals	DLS/Installer Lead In/Out
1	✓			✗	✗
2	✓	✓		✗	✗
3	✓		✓	✗	✗
4	✓	✓	✓	✗	✗
5	✓	✓			✗
6	✓		✓		✗
7	✓	✓	✓		✗
8	✓				
✓ indicates included, Blank indicates default setting, ✗ indicates disabled					

Common Group

Description	Phone 1	Phone 2	Sections
Set all Reporting Codes to automatic			[320] - [349], [601] - [608] FF
Alarm/Restore call directions enabled	✓		[351][1] ON, [2] OFF
Tamper/Restore Call directions disabled	✓	✓	[359][1] OFF, [2] OFF
Opening/Closing Call directions disabled	✓	✓	[367][1] OFF, [2] OFF
Maintenance Call Directions enabled	✓		[375][1] ON, [2] OFF
Test Transmission Call directions disabled	✓	✓	[376][1] OFF, [2] OFF

Selected Troubles

Trouble	[345] Alarms	[346] Restoral
Battery	FF	FF
AC Failure	00	00
Bell Circuit	FF	FF
Fire, Alarm	FF	FF
Aux PS	FF	FF
TLM	00	FF
General System	00	00
General System Supervisory	FF	FF
FF = Communicate in automatic format , 00 = Disabled		

Openings & Closings

Users	CLOSINGS, Residential Dial Reporting codes								Section
1-8	51	52	53	54	55	56	57	58	[339]
9-16	61	62	63	64	65	66	67	68	[339]
17-24	71	72	73	74	75	76	77	78	[340]
25-32	81	82	83	84	85	86	87	88	[340]
33-40	FF	FF	FF	FF	FF	FF	FF	98	[601]
Users	OPENINGS, Residential Dial Reporting codes								Section
1-8	11	12	13	14	15	16	17	18	[342]
9-16	21	22	23	24	25	26	27	28	[342]
17-24	31	32	33	34	35	36	37	38	[343]
25-32	41	42	43	44	45	46	47	48	[343]
33-40	FF	FF	FF	FF	FF	FF	FF	98	[605]
Enable Opening/Closings call directions for Phone 2									[367]

Zone Restorals

Zones	Alarm Restoral Reporting Codes								Section
1-64	00	00	00	00	00	00	00	00	[324]-[327]
00 = Disabled									

DLS/Installer Lead IN/OUT

Miscellaneous Maintenance Reporting Codes												Section
DEF	DEF	DEF	00	00	DEF	DEF	DEF	DEF	DEF	00	00	[347]
DEF = No change to default values, 00 = Disabled												

Digit 5 selects DLS connection options.

Option	Programming Section	DLS Connection/Call back setting
1	[401] Option 1 OFF Option 3 OFF [406] 0	Double Call Disabled, Call Back Disabled Number of rings to answer on set to 0
2	[401] Option 1 ON Option 3 OFF [406] 9	Double Call Enabled, Call Back Disabled Number of rings to answer on set to 9
3	[401] Option 1 ON Option 3 ON [406] 9	Double Call Enabled, Call Back Enabled Number of rings to answer on set to 9

Note to Installers

This warning contains vital information. As the only individual in contact with system users, it is your responsibility to bring each item in this warning to the attention of the users of this system.

System Failures

This system has been carefully designed to be as effective as possible. There are circumstances, however, involving fire, burglary, or other types of emergencies where it may not provide protection. Any alarm system of any type may be compromised deliberately or may fail to operate as expected for a variety of reasons. Some but not all of these reasons may be:

• Inadequate Installation

A security system must be installed properly in order to provide adequate protection. Every installation should be evaluated by a security professional to ensure that all access points and areas are covered. Locks and latches on windows and doors must be secure and operate as intended. Windows, doors, walls, ceilings and other building materials must be of sufficient strength and construction to provide the level of protection expected. A reevaluation must be done during and after any construction activity. An evaluation by the fire and/or police department is highly recommended if this service is available.

• Criminal Knowledge

This system contains security features which were known to be effective at the time of manufacture. It is possible for persons with criminal intent to develop techniques which reduce the effectiveness of these features. It is important that a security system be reviewed periodically to ensure that its features remain effective and that it be updated or replaced if it is found that it does not provide the protection expected.

• Access by Intruders

Intruders may enter through an unprotected access point, circumvent a sensing device, evade detection by moving through an area of insufficient coverage, disconnect a warning device, or interfere with or prevent the proper operation of the system.

• Power Failure

Control units, intrusion detectors, smoke detectors and many other security devices require an adequate power supply for proper operation. If a device operates from batteries, it is possible for the batteries to fail. Even if the batteries have not failed, they must be charged, in good condition and installed correctly. If a device operates only by AC power, any interruption, however brief, will render that device inoperative while it does not have power. Power interruptions of any length are often accompanied by voltage fluctuations which may damage electronic equipment such as a security system. After a power interruption has occurred, immediately conduct a complete system test to ensure that the system operates as intended.

• Failure of Replaceable Batteries

This system's wireless transmitters have been designed to provide several years of battery life under normal conditions. The expected battery life is a function of the device environment, usage and type. Ambient conditions such as high humidity, high or low temperatures, or large temperature fluctuations may reduce the expected battery life. While each transmitting device has a low battery monitor which identifies when the batteries need to be replaced, this monitor may fail to operate as expected. Regular testing and maintenance will keep the system in good operating condition.

• Compromise of Radio Frequency (Wireless) Devices

Signals may not reach the receiver under all circumstances which could include metal objects placed on or near the radio path or deliberate jamming or other inadvertent radio signal interference.

• System Users

A user may not be able to operate a panic or emergency switch possibly due to permanent or temporary physical disability, inability to reach the device in time, or unfamiliarity with the correct operation. It is important that all system users be trained in the correct operation of the alarm system and that they know how to respond when the system indicates an alarm.

• Smoke Detectors

Smoke detectors that are a part of this system may not properly alert occupants of a fire for a number of reasons, some of which follow. The smoke detectors may have been improperly installed or positioned. Smoke may not be able to reach the smoke detectors, such as when the fire is in a chimney, walls or roofs, or on the other side of closed doors. Smoke detectors may not detect smoke from fires on another level of the residence or building.

Every fire is different in the amount of smoke produced and the rate of burning. Smoke detectors cannot sense all types of fires equally well. Smoke detectors may not provide timely warning of fires caused by carelessness or safety hazards such as smoking in bed, violent explosions, escaping gas, improper storage of flammable materials, overloaded electrical circuits, children playing with matches or arson.

Even if the smoke detector operates as intended, there may be circumstances when there is insufficient warning to allow all occupants to escape in time to avoid injury or death.

• Motion Detectors

Motion detectors can only detect motion within the designated areas as shown in their respective installation instructions. They cannot discriminate between intruders and intended occupants. Motion detectors do not provide volumetric area protection. They have multiple beams of detection and motion can only be detected in unobstructed areas covered by these beams. They cannot detect motion which occurs behind walls, ceilings, floor, closed doors, glass partitions, glass doors or windows. Any type of tampering whether intentional or unintentional such as masking, painting, or spraying of any material on the lenses, mirrors, windows or any other part of the detection system will impair its proper operation.

Passive infrared motion detectors operate by sensing changes in temperature. However their effectiveness can be reduced when the ambient temperature rises near or above body temperature or if there are intentional or unintentional sources of heat in or near the detection area. Some of these heat sources could be heaters, radiators, stoves, barbecues, fireplaces, sunlight, steam vents, lighting and so on.

• Warning Devices

Warning devices such as sirens, bells, horns, or strobes may not warn people or waken someone sleeping if there is an intervening wall or door. If warning devices are located on a different level of the residence or premise, then it is less likely that the occupants will be alerted or awakened. Audible warning devices may be interfered with by other noise sources such as stereos, radios, televisions, air conditioners or other appliances, or passing traffic. Audible warning devices, however loud, may not be heard by a hearing-impaired person.

• Telephone Lines

If telephone lines are used to transmit alarms, they may be out of service or busy for certain periods of time. Also an intruder may cut the telephone line or defeat its operation by more sophisticated means which may be difficult to detect.

• Insufficient Time

There may be circumstances when the system will operate as intended, yet the occupants will not be protected from the emergency due to their inability to respond to the warnings in a timely manner. If the system is monitored, the response may not occur in time to protect the occupants or their belongings.

• Component Failure

Although every effort has been made to make this system as reliable as possible, the system may fail to function as intended due to the failure of a component.

• Inadequate Testing

Most problems that would prevent an alarm system from operating as intended can be found by regular testing and maintenance. The complete system should be tested weekly and immediately after a break-in, an attempted break-in, a fire, a storm, an earthquake, an accident, or any kind of construction activity inside or outside the premises. The testing should include all sensing devices, keypads, consoles, alarm indicating devices and any other operational devices that are part of the system.

• Security and Insurance

Regardless of its capabilities, an alarm system is not a substitute for property or life insurance. An alarm system also is not a substitute for property owners, renters, or other occupants to act prudently to prevent or minimize the harmful effects of an emergency situation.

Limited Warranty

Digital Security Controls warrants the original purchaser that for a period of twelve months from the date of purchase, the product shall be free of defects in materials and workmanship under normal use. During the warranty period, Digital Security Controls shall, at its option, repair or replace any defective product upon return of the product to its factory, at no charge for labour and materials. Any replacement and/or repaired parts are warranted for the remainder of the original warranty or ninety (90) days, whichever is longer. The original purchaser must promptly notify Digital Security Controls in writing that there is defect in material or workmanship, such written notice to be received in all events prior to expiration of the warranty period. There is absolutely no warranty on software and all software products are sold as a user license under the terms of the software license agreement included with the product. The Customer assumes all responsibility for the proper selection, installation, operation and maintenance of any products purchased from DSC. Custom products are only warranted to the extent that they do not function upon delivery. In such cases, DSC can replace or credit at its option.

International Warranty

The warranty for international customers is the same as for any customer within Canada and the United States, with the exception that Digital Security Controls shall not be responsible for any customs fees, taxes, or VAT that may be due.

Warranty Procedure

To obtain service under this warranty, please return the item(s) in question to the point of purchase. All authorized distributors and dealers have a warranty program. Anyone returning goods to Digital Security Controls must first obtain an authorization number. Digital Security Controls will not accept any shipment whatsoever for which prior authorization has not been obtained.

Conditions to Void Warranty

This warranty applies only to defects in parts and workmanship relating to normal use. It does not cover:

- damage incurred in shipping or handling;
- damage caused by disaster such as fire, flood, wind, earthquake or lightning;
- damage due to causes beyond the control of Digital Security Controls such as excessive voltage, mechanical shock or water damage;
- damage caused by unauthorized attachment, alterations, modifications or foreign objects;
- damage caused by peripherals (unless such peripherals were supplied by Digital Security Controls Ltd.);
- defects caused by failure to provide a suitable installation environment for the products;
- damage caused by use of the products for purposes other than those for which it was designed;
- damage from improper maintenance;
- damage arising out of any other abuse, mishandling or improper application of the products.

Items Not Covered by Warranty

In addition to the items which void the Warranty, the following items shall not be covered by Warranty: (i) freight cost to the repair centre; (ii) products which are not identified with DSC's product label and lot number or serial number; (iii) products disassembled or repaired in such a manner as to adversely affect performance or prevent adequate inspection or testing to verify any warranty claim. Access cards or tags returned for replacement under warranty will be credited or replaced at DSC's option. Products not covered by this warranty, or otherwise out of warranty due to age, misuse, or damage shall be evaluated, and a repair estimate shall be provided. No repair work will be performed until a valid purchase order is received from the Customer and a Return Merchandise Authorization number (RMA) is issued by DSC's Customer Service.

Digital Security Controls Ltd.'s liability for failure to repair the product under this warranty after a reasonable number of attempts will be limited to a replacement of the product, as the exclusive remedy for breach of warranty. Under no circumstances shall Digital Security Controls be liable for any special, incidental, or consequential damages based upon breach of warranty, breach of contract, negligence, strict liability, or any other legal theory. Such damages include, but are not limited to, loss of profits, loss of the product or any associated equipment, cost of capital, cost of substitute or replacement equipment, facilities or services, down time, purchaser's time, the claims of third parties, including customers, and injury to property. The laws of some jurisdictions limit or do not allow the disclaimer of consequential damages. If the laws of such a jurisdiction apply to any claim by or against DSC, the limitations and disclaimers contained here shall be to the greatest extent permitted by law. Some states do not allow the exclusion or limitation of incidental or consequential damages, so that the above may not apply to you.

Disclaimer of Warranties

This warranty contains the entire warranty and shall be in lieu of any and all other warranties, whether expressed or implied (including all implied warranties of merchantability or fitness for a particular purpose) and of all other obligations or liabilities on the part of Digital Security Controls. Digital Security Controls neither assumes responsibility for, nor authorizes any other person purporting to act on its behalf to modify or to change this warranty, nor to assume for it any other warranty or liability concerning this product. This disclaimer of warranties and limited warranty are governed by the laws of the province of Ontario, Canada.

WARNING: Digital Security Controls recommends that the entire system be completely tested on a regular basis. However, despite frequent testing, and due to, but not limited to, criminal tampering or electrical disruption, it is possible for this product to fail to perform as expected.

Out of Warranty Repairs

Digital Security Controls will at its option repair or replace out-of-warranty products which are returned to its factory according to the following conditions. Anyone returning goods to Digital Security Controls must first obtain an authorization number. Digital Security Controls will not accept any shipment whatsoever for which prior authorization has not been obtained.

Products which Digital Security Controls determines to be repairable will be repaired and returned. A set fee which Digital Security Controls has predetermined and which may be revised from time to time, will be charged for each unit repaired.

Products which Digital Security Controls determines not to be repairable will be replaced by the nearest equivalent product available at that time. The current market price of the replacement product will be charged for each replacement unit.

FCC COMPLIANCE STATEMENT

CAUTION: Changes or modifications not expressly approved by Digital Security Controls could void your authority to use this equipment.

This equipment has been tested and found to comply with the limits for a Class B digital device, pursuant to Part 15 of the FCC Rules. These limits are designed to provide reasonable protection against harmful interference in a residential installation. This equipment generates, uses and can radiate radio frequency energy and, if not installed and used in accordance with the instructions, may cause harmful interference to radio communications. However, there is no guarantee that interference will not occur in a particular installation. If this equipment does cause harmful interference to radio or television reception, which can be determined by turning the equipment off and on, the user is encouraged to try to correct the interference by one or more of the following measures:

- Re-orient the receiving antenna.
- Increase the separation between the equipment and receiver.
- Connect the equipment into an outlet on a circuit different from that to which the receiver is connected.
- Consult the dealer or an experienced radio/television technician for help.

The user may find the following booklet prepared by the FCC useful: "How to Identify and Resolve Radio/Television Interference Problems". This booklet is available from the U.S. Government Printing Office, Washington D.C. 20402, Stock # 004-000-00345-4.

IMPORTANT INFORMATION

This equipment complies with Part 68 of the FCC Rules. On the side of this equipment is a label that contains, among other information, the FCC registration number and ringer equivalence number (REN) for this equipment. If requested, this number must be provided to the Telephone Company.

PC1864 Product Identifier	US: F53AL01BPC1864
PC1832 Product Identifier	US: F53AL01BPC1832
PC1616 Product Identifier	US: F53AL01BPC1614
REN:	0.1B
USOC Jack:	RJ-31X

Telephone Connection Requirements

A plug and jack used to connect this equipment to the premises wiring and telephone network must comply with the applicable FCC Part 68 rules and requirements adopted by the ACTA. A compliant telephone cord and modular plug is provided with this product. It is designed to be connected to a compatible modular jack that is also compliant. See installation instructions for details.

Ringer Equivalence Number (REN)

The REN is used to determine the number of devices that may be connected to a telephone line. Excessive RENs on a telephone line may result in the devices not ringing in response to an incoming call.

In most but not all areas, the sum of RENs should not exceed five (5.0). To be certain of the number of devices that may be connected to a line, as determined by the total RENs, contact the local Telephone Company. For products approved after July 23, 2001, the REN for this product is part of the product identifier that has the format.

US: AAAEQ##TXXXX. The digits represented by ## are the REN without a decimal point (e.g., 03 is a REN of 0.3). For earlier products, the REN is separately shown on the label.

Incidence of Harm

If this equipment PC1864/PC1832/PC1616 causes harm to the telephone network, the telephone company will notify you in advance that temporary discontinuance of service may be required. But if advance notice is not practical, the Telephone Company will notify the customer as soon as possible. Also, you will be advised of your right to file a complaint with the FCC if you believe it is necessary.

Changes in Telephone Company Equipment or Facilities

The Telephone Company may make changes in its facilities, equipment, operations or procedures that could affect the operation of the equipment. If this happens the Telephone

Company will provide advance notice in order for you to make necessary modifications to maintain uninterrupted service.

Equipment Maintenance Facility

If trouble is experienced with this equipment PC1616, PC1832, PC1864 for repair or warranty information, please contact the facility indicated below. If the equipment is causing harm to the telephone network, the Telephone Company may request that you disconnect the equipment until the problem is solved. This equipment is of a type that is not intended to be repaired by the end user.

DSC c/o APL Logistics, 757 Douglas Hill Rd., Lithia Springs, GA 30122

Additional Information

Connection to party line service is subject to state tariffs. Contact the state public utility commission, public service commission or corporation commission for information. Alarm dialling equipment must be able to seize the telephone line and place a call in an emergency situation. It must be able to do this even if other equipment (telephone, answering system, computer modem, etc.) already has the telephone line in use. To do so, alarm dialling equipment must be connected to a properly installed RJ-31X jack that is electrically in series with and ahead of all other equipment attached to the same telephone line. Proper installation is depicted in the figure below. If you have any questions concerning these instructions, you should consult your telephone company or a qualified installer about installing the RJ-31X jack and alarm dialling equipment for you.

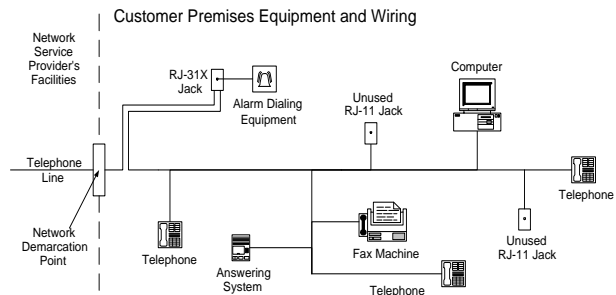

INDUSTRY CANADA STATEMENT

NOTICE: This Equipment meets the applicable Industry Canada Terminal Equipment Technical Specifications. This is confirmed by the registration number. The abbreviation, IC, before the registration number signifies that registration was performed based on a Declaration of Conformity indicating that Industry Canada technical specifications were met. It does not imply that that Industry Canada approved the equipment

NOTICE: The Ringer Equivalence Number (REN) for this terminal equipment is 0.1. The REN assigned to each terminal equipment provides an indication of the maximum number of terminals allowed to be connected to a telephone interface. The termination on an interface may consist of any combination of devices subject only to the requirement that the sum of the Ringer Equivalence Numbers of all devices does not exceed five.

PC1616 Registration number	IC: 160A-PC1614
PC1832 Registration number	IC: 160A-PC1832
PC1864 Registration number	IC: 160A-PC1864

DSC®

© 2007, Digital Security Controls
Tech Support: 1-800-387-3630 (Canada & U.S.) or 905-760-3036
Printed in Canada • www.dsc.com

