

Addressable Fire Alarm Control Panel
MS-9200UDLS
MS-9200UDLSE

IMPORTANT! The SLC Manual Document #51309 must be referenced in addition to this manual when installing or servicing the Fire Alarm Control Panel.

Fire Alarm System Limitations

An automatic fire alarm system—typically made up of smoke detectors, heat detectors, manual pull stations, audible warning devices, and a fire alarm control panel with remote notification capability—can provide early warning of a developing fire. Such a system, however, does not assure protection against property damage or loss of life resulting from a fire.

The Manufacturer recommends that smoke and/or heat detectors be located throughout a protected premise following the recommendations of the current edition of the National Fire Protection Association Standard 72 (NFPA 72), manufacturer's recommendations, State and local codes, and the recommendations contained in the Guides for Proper Use of System Smoke Detectors, which are made available at no charge to all installing dealers. These documents can be found at <http://www.systemsensor.com/html/applicat.html>. A study by the Federal Emergency Management Agency (an agency of the United States government) indicated that smoke detectors may not go off in as many as 35% of all fires. While fire alarm systems are designed to provide early warning against fire, they do not guarantee warning or protection against fire. A fire alarm system may not provide timely or adequate warning, or simply may not function, for a variety of reasons:

Smoke detectors may not sense fire where smoke cannot reach the detectors such as in chimneys, in or behind walls, on roofs, or on the other side of closed doors. Smoke detectors also may not sense a fire on another level or floor of a building. A second-floor detector, for example, may not sense a first-floor or basement fire.

Particles of combustion or "smoke" from a developing fire may not reach the sensing chambers of smoke detectors because:

- Barriers such as closed or partially closed doors, walls, or chimneys may inhibit particle or smoke flow.
- Smoke particles may become "cold," stratify, and not reach the ceiling or upper walls where detectors are located.
- Smoke particles may be blown away from detectors by air outlets.
- Smoke particles may be drawn into air returns before reaching the detector.

The amount of "smoke" present may be insufficient to alarm smoke detectors. Smoke detectors are designed to alarm at various levels of smoke density. If such density levels are not created by a developing fire at the location of detectors, the detectors will not go into alarm.

Smoke detectors, even when working properly, have sensing limitations. Detectors that have photoelectronic sensing chambers tend to detect smoldering fires better than flaming fires, which have little visible smoke. Detectors that have ionizing-type sensing chambers tend to detect fast-flaming fires better than smoldering fires. Because fires develop in different ways and are often unpredictable in their growth, neither type of detector is necessarily best and a given type of detector may not provide adequate warning of a fire.

Smoke detectors cannot be expected to provide adequate warning of fires caused by arson, children playing with matches (especially in bedrooms), smoking in bed, and violent explosions (caused by escaping gas, improper stor-

While a fire alarm system may lower insurance rates, it is not a substitute for fire insurance!

age of flammable materials, etc.).

Heat detectors do not sense particles of combustion and alarm only when heat on their sensors increases at a predetermined rate or reaches a predetermined level. Rate-of-rise heat detectors may be subject to reduced sensitivity over time. For this reason, the rate-of-rise feature of each detector should be tested at least once per year by a qualified fire protection specialist. *Heat detectors are designed to protect property, not life.*

IMPORTANT! Smoke detectors must be installed in the same room as the control panel and in rooms used by the system for the connection of alarm transmission wiring, communications, signaling, and/or power. If detectors are not so located, a developing fire may damage the alarm system, crippling its ability to report a fire.

Audible warning devices such as bells may not alert people if these devices are located on the other side of closed or partly open doors or are located on another floor of a building. Any warning device may fail to alert people with a disability or those who have recently consumed drugs, alcohol or medication. Please note that:

- Strobes can, under certain circumstances, cause seizures in people with conditions such as epilepsy.
- Studies have shown that certain people, even when they hear a fire alarm signal, do not respond or comprehend the meaning of the signal. It is the property owner's responsibility to conduct fire drills and other training exercise to make people aware of fire alarm signals and instruct them on the proper reaction to alarm signals.
- In rare instances, the sounding of a warning device can cause temporary or permanent hearing loss.

A fire alarm system will not operate without any electrical power. If AC power fails, the system will operate from standby batteries only for a specified time and only if the batteries have been properly maintained and replaced regularly.

Equipment used in the system may not be technically compatible with the control. It is essential to use only equipment listed for service with your control panel.

Telephone lines needed to transmit alarm signals from a premise to a central monitoring station may be out of service or temporarily disabled. For added protection against telephone line failure, backup radio transmission systems are recommended.

The most common cause of fire alarm malfunction is inadequate maintenance. To keep the entire fire alarm system in excellent working order, ongoing maintenance is required per the manufacturer's recommendations, and UL and NFPA standards. At a minimum, the requirements of NFPA 72 shall be followed. Environments with large amounts of dust, dirt or high air velocity require more frequent maintenance. A maintenance agreement should be arranged through the local manufacturer's representative. Maintenance should be scheduled monthly or as required by National and/or local fire codes and should be performed by authorized professional fire alarm installers only. Adequate written records of all inspections should be kept.

Installation Precautions

WARNING - Several different sources of power can be connected to the fire alarm control panel. Disconnect all sources of power before servicing. Control unit and associated equipment may be damaged by removing and/or inserting cards, modules, or interconnecting cables while the unit is energized. Do not attempt to install, service, or operate this unit until this manual is read and understood.

CAUTION - *System Reacceptance Test after Software Changes*. To ensure proper system operation, this product must be tested in accordance with NFPA 72 after any programming operation or change in site-specific software. Reacceptance testing is required after any change, addition or deletion of system components, or after any modification, repair or adjustment to system hardware or wiring.

All components, circuits, system operations, or software functions known to be affected by a change must be 100% tested. In addition, to ensure that other operations are not inadvertently affected, at least 10% of initiating devices that are not directly affected by the change, up to a maximum of 50 devices, must also be tested and proper system operation verified.

This system meets NFPA requirements for indoor dry operation at 0-49° C/32-120° F and at a relative humidity of 93 ±2% RH (non-condensing) at 32 ±2° C/90 ±3° F. However, the useful life of the system's standby batteries and the electronic components may be adversely affected by extreme temperature ranges and humidity. Therefore, it is recommended that this system and all peripherals be installed in an environment with a nominal room temperature of 15-27° C/60-80° F.

Verify that wire sizes are adequate for all initiating and indicating device loops. Refer to manual Specifications section for maximum allowable I.R. drop from the specified device voltage.

Adherence to the following will aid in problem-free installation with long-term reliability:

Like all solid state electronic devices, this system may operate erratically or can be damaged when subjected to lightning-induced transients. Although no system is completely immune from lightning transients and interferences, proper grounding will reduce susceptibility. *Overhead or outside aerial wiring is not recommended, due to an increased susceptibility to nearby lightning strikes.* Consult with the Technical Services Department if any problems are anticipated or encountered.

Disconnect AC power and batteries prior to removing or inserting circuit boards. Failure to do so can damage circuits.

Remove all electronic assemblies prior to any drilling, filing, reaming, or punching of the enclosure. When possible, make all cable entries from the sides or rear. Before making modifications, verify that they will not interfere with battery, transformer, and printed circuit board location.

Do not tighten screw terminals more than 9 in-lbs. Over-tightening may damage threads, resulting in reduced terminal contact pressure and difficulty with screw terminal removal.

This system contains static-sensitive components. Always ground yourself with a proper wrist strap before handling any circuits so that static charges are removed from the body. Use static-suppressive packaging to protect electronic assemblies removed from the unit.

Follow the instructions in the installation, operating, and programming manuals. These instructions must be followed to avoid damage to the control panel and associated equipment. FACP operation and reliability depend upon proper installation by authorized personnel.

FCC Warning

WARNING: This equipment generates, uses, and can radiate radio frequency energy and if not installed and used in accordance with the instruction manual, may cause interference to radio communications. It has been tested and found to comply with the limits for class A computing device pursuant to Subpart B of Part 15 of FCC Rules, which is designed to provide reasonable protection against such interference when operated in a commercial environment. Operation of this equipment in a residential area is likely to cause interference, in which case the user will be required to correct the interference at their own expense.

Canadian Requirements

This digital apparatus does not exceed the Class A limits for radiation noise emissions from digital apparatus set out in the Radio Interference Regulations of the Canadian Department of Communications. This Class A digital apparatus complies with Canadian ICES-003.

Le present appareil numerique n'emet pas de bruits radioelectriques depassant les limites applicables aux appareils numeriques de la classe A prescrites dans le Reglement sur le brouillage radioelectrique edicte par le ministere des Communications du Canada. Cet appareil numerique de la Classe A est conforme a la norme NMB-003 du Canada.

Notes

Product Description14

- Features and Options 14
- Specifications 16
 - Current Availability 17
- Controls and Indicators 18
- Circuits 19
- Digital Alarm Communicator/Transmitter 19
- Components 20
 - Intelligent Addressable Detectors: Newer Series 20
 - Intelligent Addressable Modules: Newer Series 20
 - 300 Series Intelligent Addressable Devices 21
 - Addressable Device Accessories 21
- Optional Modules 21
- Accessories 22
 - PS-Tools Programming Utility 22
 - DP-9692 Dress Panel 22
 - Trim Ring 22
 - Battery Box 22
 - Battery Charger 23
 - CHG-75 Battery Charger 23
 - CHG-120F Battery Charger 23
 - IPDACT- Internet Protocol DACT 23
 - ANN-BUS Annunciators/Modules 24
 - ANN-BUS Wiring 24
 - Calculating Wiring Distance for ANN-BUS Modules 24
 - Wiring Configuration 26
 - Powering ANN-BUS Devices from Auxiliary Power Supply 27
 - ANN-BUS Device Addressing 27
 - ANN-80 Remote Fire Annunciator 28
 - Specifications 28
 - Installation 28
 - Mounting 28
 - Opening/Closing Annunciator 28
 - Wiring ANN-80 to FACP 29
 - ANN-S/PG Serial/Parallel Interface Installation 31
 - Specifications 31
 - PRN-6F Printer Installation 31
 - ANN-I/O LED Driver Module 33
 - ANN-I/O Board Layout 33
 - Specifications 33
 - ANN-I/O Connection to FACP 34
 - ANN-I/O Module LED Wiring 34
 - ANN-LED Annunciator Module 35
 - ANN-LED Board Layout 36
 - Specifications 36
 - Mounting/Installation 36
 - ANN-LED Connection to FACP 37
 - ANN-RLY Annunciator Module 38
 - ANN-RLY Board Layout 38
 - Specifications 38
 - Mounting/Installation 38
 - ANN-RLY Connection to FACP 39
 - ANN-BUS Audio Panel Control 39
 - Legacy ACS Series LED Zone Type Annunciators 41
- Getting Started 41

Telephone Requirements and Warnings	42
Telephone Circuitry	42
Digital Communicator	42
Telephone Company Rights and Warnings	43
For Canadian Applications	44
Installation	45
Mounting Backbox	45
Mounting Optional Transformer/Remounting Chassis	46
Power	49
AC Power and Earth Ground Connection	49
Battery Power	49
Special Application DC Power Output Connection	49
Relays	50
Notification Appliance Circuits	50
Configuring NACs	51
Style Y (Class B) NAC Wiring	51
Style Z (Class A) NAC Wiring	52
Remote Synchronization Output	52
UL Power-limited Wiring Requirements	53
Digital Communicator	54
Optional Module Installation	55
4XTMF Transmitter Module Installation	56
Printer	57
Programming	59
Programming Data Entry	59
User Programming	60
Initial Power-up	61
Programming Screens Description	61
Programming and Passwords	62
Master Programming Level	63
Autoprogram	64
Point Program	65
Detector Programming	65
Add Detector	65
Delete Detector	66
Edit Detector	66
Module Programming	75
Add Module	75
Delete Module	76
Edit Module Screen for Monitor Module	76
Edit Module Screen for Control Modules	85
Zone Setup	92
Enable	92
Disable	93
Zone 97, 98 and 99	93
Zones Installed	94
Zones Enabled	94
Zones Disabled	94
Zone Type	95
Zones Available	96
Zone Message	96
Loop Setup	96
Style	96
Loop Protocol	97
System Setup	97

Table of Contents

Trouble Reminder	98
Banner	98
Time-Date	100
Time	100
Date	101
Clock Format	101
Daylight Savings Time	101
Timers	102
PAS (Positive Alarm Sequence) Delay	102
Pre-signal Delay	103
Waterflow Delay	103
AC Loss Delay	104
NAC (Notification Appliance Circuit)	104
Enabled	105
Type	106
Silenceable	106
Auto Silence	107
Coding (only for NACs not programmed as Sync Strobe Type)	107
Zone	109
Silence Inhibited	109
Sync Type	109
Relays	110
Canadian Option	111
Waterflow Silenceable	111
Verify Loop	111
History	112
View Events	112
Erase History	112
Walktest	113
Option Modules	115
Annunciators	115
Term Options	115
ACS Options	116
ANN-BUS Options	118
Onboard DACT	131
Onboard DACT Enable	131
Primary Phone	131
Secondary Phone	132
Service Terminal	132
Central Station	133
Trouble Call Limit (Dialer Runaway Prevention)	134
Supervised Phone Line	141
Printer/PC	142
Password Change	143
Clear Program	144
Program Check	145
Maintenance Programming Level	147
Disable Point	148
History	149
Program Check	150
Walktest	151
System	153
Zone Setup	154
Operating Instructions	156
Panel Control Buttons	156

Acknowledge/Step	156
Alarm Silence	156
Drill/Hold 2 Sec	156
Reset	156
LED Indicators	157
Normal Operation	158
Trouble Operation	158
Alarm Operation	160
Supervisory Operation	161
Process Monitor Operation	162
Hazard/Tornado Condition Operation	162
Medical Alert Condition Operation	162
NAC Operation	162
Programmed Zone Operation	163
Disable/Enable Operation	163
Waterflow Circuits Operation	163
Detector Functions	163
Time Functions: Real-Time Clock	163
Synchronized NAC Operation	164
Coded Operation	164
Presignal	164
Positive Alarm Sequence	165
Special System Timers	166
Silence Inhibit Timer	166
Autosilence Timer	166
Trouble Reminder	166
Waterflow Retard Timer	166
Alarm Verification (None or One Minute)	166
Walktest	167
Read Status	168
System Point	169
Zones	170
Power	171
Trouble Reminder	172
Timers	172
NAC	173
Relays	173
Program Check	174
History	174
Annunciators	174
Phone Line	176
Central Station	176
Service Terminal	177
Printer/PC	177
Print	178
Time-Date	180
Central Station Communications	181
Transmittal Priorities	182
Remote Site Upload/Download	184
Remote Download	184
Transferring a Program	185
Security Features	186
Power Supply Calculations	187
Overview	187
Calculating the AC Branch Circuit	187

Table of Contents

Calculating the System Current Draw	188
Overview	188
How to Use Table 7.3 on page 189 to Calculate System Current Draw	188
Calculating the Battery Size	190
NFPA Battery Requirements	190
Selecting and Locating Batteries	190
Software Zones	191
Correlations	191
Default Programming	197
NFPA Standard-Specific Requirements	198
Central Station/Remote Station Transmitter: Connection to FACP Dry Contacts	202
MBT-1 Municipal Box Trip - Silenceable	203
FACP with Keltron	204
Wire Requirements	205
NAC Wiring	207
HVAC Control	208
Control Module Operation	208
HVAC SHUTDN	208
Monitor Module Operation	208
HVAC RESTART	208
HVAC OVERRIDE	209
Ademco Contact ID Format Event Code Descriptions	210
Transmission Format Between DACT and Receiver	210
Ademco Contact ID Typical Printout	210
Central Station Points	215

Software Downloads

In order to supply the latest features and functionality in fire alarm and life safety technology to our customers, we make frequent upgrades to the embedded software in our products. To ensure that you are installing and programming the latest features, we strongly recommend that you download the most current version of software for each product prior to commissioning any system. Contact Technical Support with any questions about software and the appropriate version for a specific application.

It is imperative that the installer understand the requirements of the Authority Having Jurisdiction (AHJ) and be familiar with the standards set forth by the following regulatory agencies:

- Underwriters Laboratories Standards
- NFPA 72 National Fire Alarm Code
- CAN/ULC - S527-99 Standard for Control Units for Fire Alarm Systems

Before proceeding, the installer should be familiar with the following documents.



NFPA Standards

NFPA 72 National Fire Alarm Code
 NFPA 70 National Electrical Code



Underwriters Laboratories Documents:

UL 38 Manually Actuated Signaling Boxes
 UL 217 Smoke Detectors, Single and Multiple Station
 UL 228 Door Closers-Holders for Fire Protective Signaling Systems
 UL 268 Smoke Detectors for Fire Protective Signaling Systems
 UL 268A Smoke Detectors for Duct Applications
 UL 346 Waterflow Indicators for Fire Protective Signaling Systems
 UL 464 Audible Signaling Appliances
 UL 521 Heat Detectors for Fire Protective Signaling Systems
 UL 864 Standard for Control Units for Fire Protective Signaling Systems
 UL 1481 Power Supplies for Fire Protective Signaling Systems
 UL 1610 Central Station Burglar Alarm Units
 UL 1638 Visual Signaling Appliances
 UL 1971 Signaling Devices for Hearing Impaired
 UL 2017 General-Purpose Signaling Devices and Systems



CAN/ULC - S524-01 Standard for Installation of Fire Alarm Systems

Other:

EIA-232E Serial Interface Standard
 EIA-485 Serial Interface Standard
 NEC Article 250 Grounding
 NEC Article 300 Wiring Methods
 NEC Article 760 Fire Protective Signaling Systems
 Applicable Local and State Building Codes
 Requirements of the Local Authority Having Jurisdiction (LAHJ)

Fire-Lite Documents:

Fire-Lite Device Compatibility	Document #15384
SLC Wiring Manual	Document #51309
ACS Series Annunciators	Document #51480
CHG-120F Battery Charger	Document #50888
CHG-75 Battery Charger	Document #51315
LDM Series Lamp Driver Modules	Document #50055
LCD-80F Remote Fire Annunciator	Document #51338
ACM-8RF Relay Control Module	Document #50362
IPDACT Communicator/Transmitter	Document #53109
ANN-80 Product Installation Document	Document #52749
ANN-(R)LED Product Installation Doc.	Document #53032
ANN-I/O Product Installation Document	Document #151416
ANN-RLY Product Installation Document	Document #53033
ANN-S/PG Product Installation Document	Document #151417
ACC-25/50(ZS/T) Manual	Document #52750

This product has been certified to comply with the requirements in the Standard for Control Units and Accessories for Fire Alarm Systems, UL 864, 9th Edition. Operation of this product with products not tested for UL 864, 9th Edition has not been evaluated. Such operation requires the approval of the local Authority Having Jurisdiction (AHJ).

Basic System Connections

Notification Appliance Circuits

NAC #1, #2, #3 & #4, Style Y (Class B) (Supervised, Power Limited) (Special Application) 2.5 amps max. per circuit. JP6 configured for Class B using NACKKEY card.
(See Style Z illustrated near right edge of board).

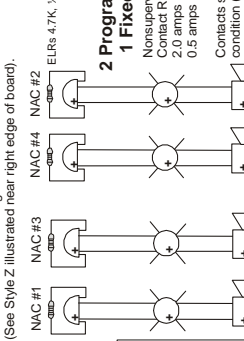

EIA-232 to Printer or personal computer

(non-supervised)
For EDP-listed equipment or personal computer, the PCP board must be installed in the 50 foot maximum within same room.

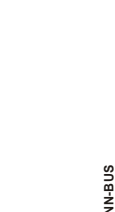

Remote Synchronization Output

Special Application Power
24 VDC filtered, supervised and power-limited.
0.040 amps maximum, follows NAC1 control circuit.
Requires 4.7kohm End-of-Line resistor.

Special Application DC Power Outputs (24 VDC)

Non-supervised, power-limited circuits
Supervise with a power supervision relay A77-716B
Resettable Power - 24 VDC filtered, power-limited (0.300 amps maximum) to smoke detectors (IDC).
Supervision required.

Non-resettable or Resettable Power
Jumper selectable by JP4, 24 VDC filtered, power-limited (0.300 amps maximum) to smoke detectors.
Supervision required. Non-resettable
Power suitable for powering annunciators.
Resettable Power suitable for powering smoke detectors.

Configure TB1, Terminals 1 & 2 as Resettable or Nonresettable Power, Nonresettable Power - jumper pins 1 & 2 (as shown).
Resettable Power - jumper pins 2 & 3.

For more specific UL wiring information refer to page 33.

Important! Removing Ground Fault Disable Jumper JP7 voids UL/NFPA Style/Class identifications for circuits. Remove jumper JP7 only with the approval of the AHJ (Authority Having Jurisdiction)

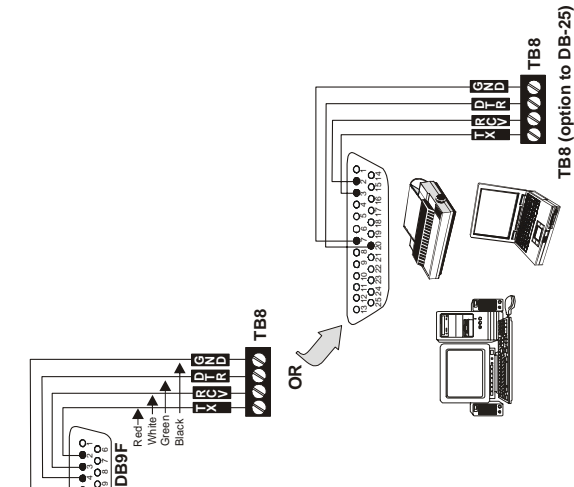

Notification Appliance Circuits

NAC #1 & #2
Style Z (Class A) (Supervised, Power Limited)
2.5 amps max. per circuit.
JP6 configured for Class A using NACKKEY card.

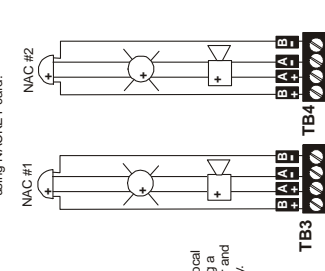

USB Port J12 for local programming using a personal computer and programming utility.

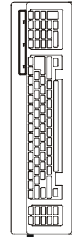

AC Power
(Supervised, Nonpower-Limited)
120 VAC, 60 HZ, 3.0 amps
220/240 VAC, 50 Hz, 1.5 amps
18 Amp Hour maximum

Battery
24 VDC supervised, nonpower-limited
18 Amp Hour maximum

CAUTION! HIGH VOLTAGE

Peripheral Devices and Their Documents:

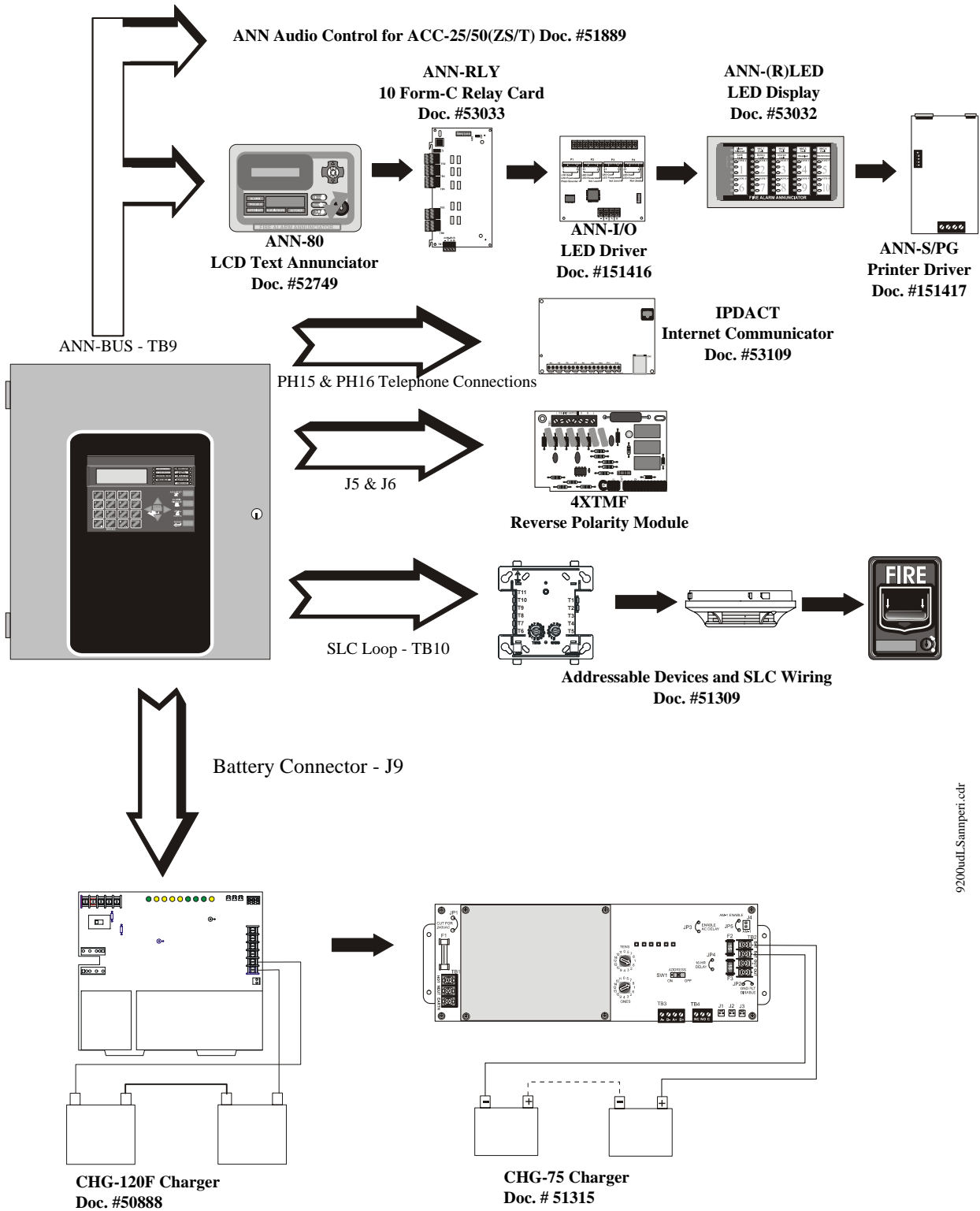

9200udl.Sampneri.cdr

SECTION 1 Product Description

The Fire-Lite MS-9200UDLS is a combination FACP (Fire Alarm Control Panel) and DACT (Digital Alarm Communicator/Transmitter) all on one circuit board. This compact, cost effective, intelligent addressable control panel has an extensive list of powerful features. The combination of Fire-Lite's newer series devices and legacy 300 Series devices, along with the MS-9200UDLS FACP, offer the latest in fire protection technology. The power supply and all electronics are contained on a single circuit board housed in a metal cabinet, providing a complete fire control system for most applications. Optional modules, which plug into the main circuit board, are available for special functions. Available accessories include LED, graphic and LCD annunciators, reverse polarity/city box transmitter, local and remote upload/download software and remote power expansion.

The integral DACT transmits system status (alarms, troubles, AC loss, etc.) to a Central Station via the public switched telephone network. It also allows remote programming or interrogation of the control panel using the PS-Tools Upload/Download utility via the public switched telephone network. Local programming and interrogation is also possible using the PS-Tools and the USB port (J12) on the FACP. Any personal computer with Windows™ XP or greater, and compatible modem with a speed of 2400 baud or faster and PS-Tools software may serve as a Service Terminal. This allows download of the entire program or upload of the entire program, history file, walktest data, current status and system voltages.

MS-9200UDLS is used in this manual to refer to both the MS-9200UDLS (120 VAC version) and the MS-9200UDLSE (240 VAC version) FACPs.

Inventory

When MS-9200UDLS shipment is received, check that all parts have been included in shipment. The MS-9200UDLS shipment consists of one of each of the following:

- ✓ main circuit board with display
- ✓ backbox with door
- ✓ plastic bag containing screws, cables, key, etc.
- ✓ manual

1.1 Features and Options

- New LiteSpeed™ polling protocol for faster SLC response time
- SLC operates up to 10,000 ft. (3,000 m) in LiteSpeed mode with twisted, unshielded wire (refer to "Wire Requirements" on page 205)
- Built-in DACT (Digital Alarm Communicator/Transmitter)
- Single addressable SLC loop which meets NFPA Style 4, 6 and 7 requirements
- 198 addressable device capacity (99 detectors and 99 control/relay/monitor modules)
- 99 software zones
- Onboard NACs (Notification Appliance Circuits) which can be configured as four Style Y (Class B) or two Style Z (Class A) circuits - special application
- 3.0 amps total power for NACs and 24 VDC special application auxiliary power outputs expandable to 6.0 amps
- 3.6 amps total system power (includes battery charger) expandable to 6.6 amps
- Two programmable relay outputs and one fixed trouble relay
- Synchronization output for remote power supply applications (special application)
- Built-in Programmer
- Telephone Line Active LEDs

- Communication Confirmation (*Kissoff*) LED
- Touchtone/Rotary dialing
- Programmable Make/Break Ratio
- EIA-232 Printer/PC interface (variable baud rate)
- 80-character LCD display (backlit)
- Real-time clock/calendar with daylight savings time control
- History file with 1,000 event capacity
- Advanced fire technology features:
 - ✓ Automatic drift compensation
 - ✓ Maintenance alert
 - ✓ Detector sensitivity test capability (NFPA 72 compliant)
 - ✓ Automatic device type-code verification
 - ✓ Point trouble identification
- Waterflow selection per module point
- Alarm verification selection per detector point
- Walktest, silent or audible
- PAS (Positive Alarm Sequence) and Pre-signal per point (NFPA 72 compliant)
- Silence inhibit timer option per NAC
- Autosilence timer option per NAC
- Continuous, March Time, Temporal or California code for main circuit board NACs with two-stage capability
- Selectable strobe synchronization per NAC
- Remote Acknowledge, Alarm Silence, Reset and Drill via addressable modules, ACS annunciators or ANN-80 Remote annunciator
- Auto-program (learn mode) reduces installation time. Reports two devices set to the same address
- Password and key-protected nonvolatile memory
- User programmable password
- Fully programmable from local keypad or optional keyboard
- Optional PK-CD (contains PS-Tools utility) for local or remote Upload/Download of program and data
- Compatible with Fire-Lite's newer series devices in LiteSpeed and CLIP mode (refer to SLC Wiring Manual for a list of compatible addressable devices)
- Compatible with legacy Fire-Lite 300 Series devices in CLIP mode only (refer to the SLC Wiring Manual for a list of compatible addressable devices)
- Optional 4XTMF module (conventional reverse polarity/city box transmitter)
- ANN-BUS for connection to following optional modules (cannot be used if ACS annunciators are used):
 - ✓ ANN-80 Remote Annunciator
 - ✓ ANN-I/O LED Driver
 - ✓ ANN-S/PG Printer Module
 - ✓ ANN-RLY Form-C Relay Module
 - ✓ ANN-LED Annunciator Module annunciates alarm, trouble and supervisory
 - ✓ ANN-RLED Annunciator Module annunciates alarms only
- Automated activation of the ACC-25/50(ZS/T) Audio-Command-Center
- Legacy ACS/TERM Annunciators (cannot be used if ANN annunciators are used):
 - ✓ ACS Series-LED Zone Annunciators
 - ✓ LDM Graphic Annunciator Series
 - ✓ LCD-80F Liquid Crystal Display point annunciator
 - ✓ ACM-8RF Relay Module

1.2 Specifications

Refer to Illustration on page 10 for terminal locations and connections.

AC Power - TB11

MS-9200UDLS: 120 VAC, 60 Hz, 3.0 amps

MS-9200UDLSE: 240 VAC, 50 Hz, 1.5 amps

Wire size: minimum 14 AWG (2.00 mm²) with 600 V insulation

Battery (Lead Acid Only) - J9

Maximum Charging Circuit: Normal Flat Charge - 27.6 VDC @ 0.80 amp

Maximum Battery Charger Capacity: 18 Amp Hour (FACP cabinet holds maximum of two 18 Amp Hour batteries. For greater than 26 Amp Hour up to 120 Amp Hour batteries, use the CHG-75 or CHG-120F Battery Charger and BB-55F Battery Box).

Minimum Battery Size: 7 Amp Hour

Note: Jumper JP5, on the FACP main circuit board, must be removed to disable the FACP battery charger when using an external battery charger.

Communication Loop - TB10

24 VDC nominal, 27.6 VDC maximum

Maximum length - refer to "Wire Requirements" on page 205)

Maximum loop current is 400 mA (short circuit) or 100 mA (normal)

Maximum loop resistance is 40 ohms

Supervised and power-limited circuit

Refer to SLC Loop manual for wiring information

Notification Appliance Circuits - TB3 & TB4

Each Terminal Block provides connections for two Style Y (Class B) or one Style Z (Class A) for a total of Four Style Y (Class B) or two Style Z (Class A) NACs

Style is configured using NACKEY card plugged into JP6 on main board

Special Application full-wave rectified power

Power-limited circuitry

NAC wiring requirements refer to "NAC Wiring" on page 207

Nominal operating voltage: 24 VDC

Current-limit: fuseless, electronic, power-limited circuitry

Maximum signaling current per circuit: 2.5 amps (see Figure 1.1 on page 17)

End-of-Line Resistor: 4.7 k Ω , ½ watt (P/N 71252 UL listed) for Style Y (Class B) NAC

Refer to the Device Compatibility Document for listed compatible devices

Two Programmable Relays and One Fixed Trouble Relay - TB5, TB6 & TB7

Contact rating: 2.0 amps @ 30 VDC (resistive), 0.5 amps @ 30 VAC (resistive)

Form-C relays

Refer to Figure 2.6 on page 50 for information on power-limited relay circuit wiring

Nonresettable or Resettable Special Application Power (24 VDC Nominal) - TB1, Terminals 1 (+) & 2 (-)

Jumper selectable (JP4) for conversion to resettable power output

Maximum ripple voltage: 10mV_{RMS}

Total DC current available from each output is up to 0.300 amps (see Figure 1.1)

Power-limited circuit

Four-Wire Resettable Special Application Smoke Detector Power (24 VDC nominal) - TB1, Terminals 3 (+) & 4 (-)

Maximum ripple voltage: 10 mV_{RMS}

Up to 0.300 amps is available for powering 4-wire smoke detectors (see Figure 1.1)

Power-limited circuit

Refer to the Device Compatibility Document for listed compatible devices

Remote Sync Output - TB2

Remote power supply synchronization output
 24 VDC nominal special application power
 Maximum current is 40 mA
 End-of-Line Resistor: 4.7KΩ
 Output linked to NAC 1 control
 Supervised and power-limited circuit

EIA-485 (TERM) or EIA-232 Serial - TB8

EIA-485 Terminal Mode annunciator connections: Terminal 1 (In +), 2 (In -),
 3 (Out +), 4 (Out -)
 EIA-232 PC/Printer applications connections: Terminal 1 (Transmit), 2 (Receive),
 3 (DTR) 4 (Ground)

EIA-485 ACS or ANN-BUS - TB9

ACS/ANN-BUS annunciator connector, Terminal 1 (+/A) and Terminal 2 (-/B)

1.2.1 Current Availability

The following figure illustrates the maximum current that is possible for each panel circuit and the total current available from the FACP with optional second transformer.

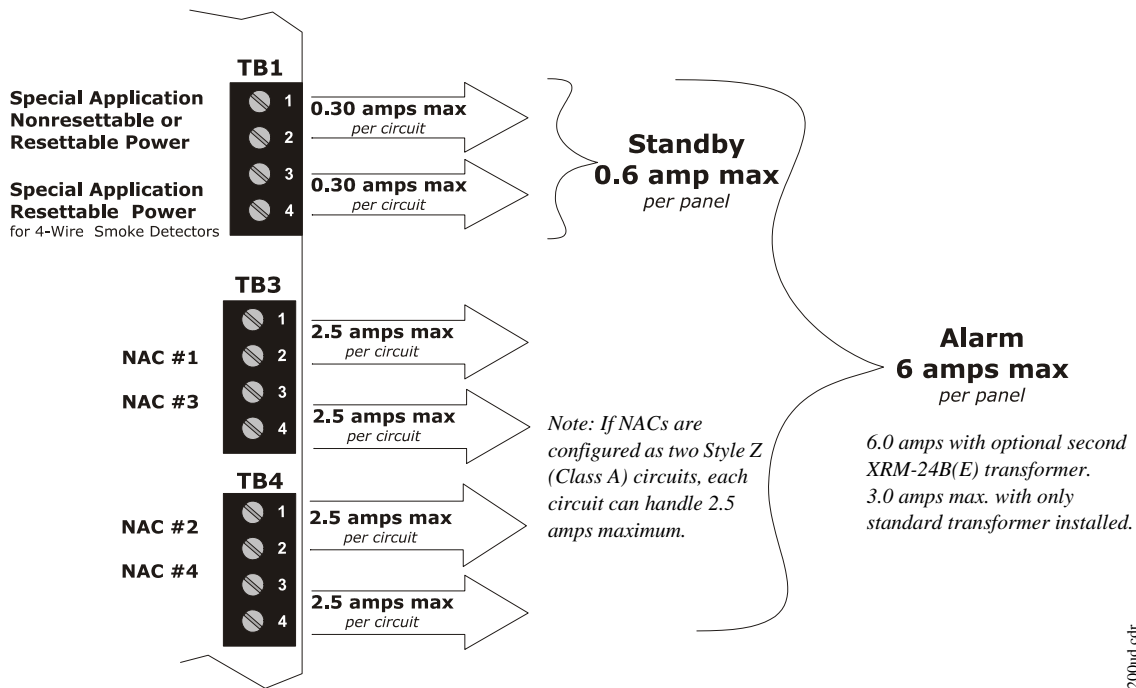

Refer to the battery calculations section for additional information.

Figure 1.1 Current Availability

powerdist9200ud.cdr

1.3 Controls and Indicators

LCD Display

The FACP uses an 80-character (4 lines X 20 characters) high viewing angle LCD display. The display includes a long life LED backlight that remains illuminated. If AC power is lost and the system is not in alarm, the LED backlight will turn off to conserve batteries.



LED Indicators

LED indicators are provided to annunciate the following conditions:

- AC Power (green)
- Fire Alarm (red)
- Supervisory (yellow)
- Trouble (yellow)
- Maintenance/presignal (yellow)
- Alarm Silenced signals (yellow)
- Disabled (yellow)
- Battery fault (yellow)
- Ground fault (yellow)

Key Panel

Mounted on the main circuit board, the key panel includes a window for the LCD display and LED indicators as listed above. The key panel, which is visible with the cabinet door closed, has 25 keys, including a 16 key alpha-numeric pad similar to a telephone keypad.

Function keys:

- Acknowledge/Step
- Alarm Silence
- Drill
- Reset (lamp test)

Service/program keys:

- Keys labeled 1 to 9
- * key
- # key
- 0 (recall) key
- 1st Event key
- Clear key
- Escape key
- Mode key
- Four cursor keys (up, down, left and right)
- Enter key

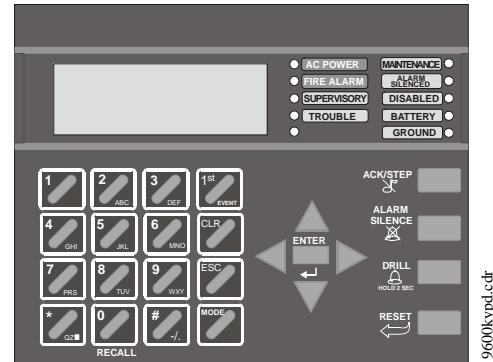

Figure 1.2 Membrane/Display Panel

Local Piezo Sounder

A piezo sounder provides separate and distinct pulse rates for alarm, trouble and supervisory conditions.

1.4 Circuits



SLC Communication Loop

One SLC loop is provided standard on the FACP main circuit board. The SLC loop, configurable for NFPA Style 4, 6 or 7, provides communication to addressable detectors, monitor (initiating device) and control (output device) modules. Refer to the SLC Wiring manual for information on wiring devices.

Output Circuits

The following output circuits are available on the FACP:

- Special Application Power
 - ✓ 24 VDC Resettable (smoke detector power) output - 0.300 amps maximum
 - ✓ 24 VDC Nonresettable or Resettable power output - 0.300 amps maximum
- 24 VDC Battery Charger (up to 18 AH batteries)

NAC (Notification Appliance Circuits)

NACs configurable for four Style Y (Class B) or two Style Z (Class A) using NACKEY card in JP6, are provided with various programmable features.

Relays

One fixed and two fully programmable Form-C dry contact relays are provided. The fixed fail-safe relay monitors system trouble and the two programmable relays are factory default programmed for system alarm and system supervisory. Contacts are rated 2.0 amps @ 30 VDC (resistive) and 0.5 amps @ 30 VAC (resistive). The programmable relays can be programmed for the following operations:

- fire alarm
- trouble
- supervisory
- supervisory auto-resettable
- DACT communication failure
- process monitor
- process monitor auto-resettable
- hazard alert
- medical alert
- AC loss

1.5 Digital Alarm Communicator/Transmitter

Two modular phone jacks allow easy connection to telephone lines. Modular jacks are labeled PH1 for Primary Phone Line and PH2 for Secondary Phone Line. Two telephone line active red LEDs are provided as well as a green *Kissoff* LED. The integral digital communicator provides the following functions:

- Line Seizure: takes control of the phone lines disconnecting any premises phones
- Off/On Hook: performs on and off-hook status to the phone lines
- Listen for dial tone: 440 Hz tone typical in most networks
- Dialing the Central Station(s) number: default is Touch-Tone®, programmable to rotary
- For tone burst or touchtone type formats: discern proper *Ack* and *Kissoff* tone(s). The frequency and time duration of the tone(s) varies with the transmission format. The control panel will adjust accordingly.
- Communicate in the following formats:
 - ✓ Ademco Contact ID
 - ✓ SIA DCS 8
 - ✓ SIA DCS 20

1.6 Components

Main Circuit Board

The main circuit board contains the system's CPU, power supply, other primary components and wiring interface connectors. The 4XTMF option module plugs in and is mounted to the main circuit board.



Cabinet

The MS-9200UDLS backbox provides space for two batteries (up to 18 Amp Hour). Ample knockouts are provided for system wiring. Also available is an optional dress panel (DP-9692), which mounts to the inside of the cabinet (required by ULC for Canadian installations).

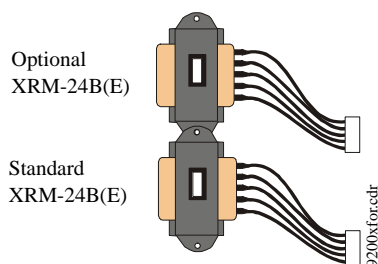

Transformer Assembly

One 100VA transformer is provided standard with the panel (3.6 amps maximum). An optional 100 VA transformer XRM-24B (XRM-24BE for the MS-9200UDLSE) is available to provide maximum system and accessory power (6.6 amp total). *Note that the XRM-24B and XRM-24BE are only suitable for use with MS-9200UDLS(E) with main circuit*

board number 03611. This circuit board can also be identified by using the software revision of #9200UDV4.0 (meaning version 4.0) or later.

Batteries

The MS-9200UDLS cabinet provides space for two batteries (up to 18 Amp Hour). Batteries larger than 18 Amp Hour require an external charger such as the CHG-75 or CHG-120F and a UL listed battery box such as the BB-55F. Batteries must be ordered separately.

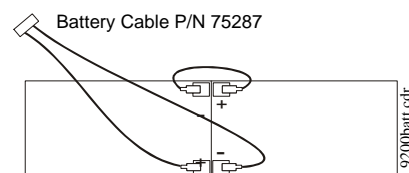

1.6.1 Intelligent Addressable Detectors: Newer Series

Intelligent, addressable detectors provide information to the control panel on an SLC Signaling Line Circuit (refer to the SLC Wiring Manual for detailed information on device installation, wiring and operation). This allows the control panel to continually process the information to determine the status (alarm, trouble, maintenance or normal) of each detector. Each detector responds to an SLC address that is set in the detector head using built-in rotary decimal switches. The maximum address cannot exceed address 99. Note that a blinking LED on an intelligent detector indicates communication between the detector and the control panel.

These devices (350 Series or newer) can operate in CLIP mode (Classic Loop Interface Protocol) or LiteSpeed mode to provide a quicker response. They are also compatible with older 300 Series devices. If a mix of old and new series devices are installed on the same loop, the FACP must be programmed to operate in CLIP mode. Refer to the SLC Wiring Manual for a list of compatible addressable detectors.

1.6.2 Intelligent Addressable Modules: Newer Series

The newer series of Control Modules and Monitor Modules provide an interface between the control panel and conventional notification and initiating devices. Each module can be set to respond to an address with built-in rotary switches. The maximum address cannot exceed address 99. Note that a blinking LED on an addressable module indicates communication between the module and the control panel.



These devices (i.e., MMF-300, MMF-301, MMF-302, CMF-300, CRF-300) can operate in CLIP mode (Classic Loop Interface Protocol) or LiteSpeed mode to provide a quicker response. They are also compatible with older 300 series devices. If a mix of old and new series devices are installed on the same loop, the FACP must be programmed to operate in CLIP mode. Refer to the SLC Wiring Manual for a list of compatible addressable modules. Refer to the Device Compatibility Document for a list of approved conventional notification and initiating devices.

1.6.3 300 Series Intelligent Addressable Devices

Fire-Lite's 300 Series Intelligent Addressable Devices are fully compatible with the MS-9200UDLS FACP. The address of 300 Series devices cannot be set above 99. Refer to the SLC Wiring Manual for a list of compatible addressable devices.

1.6.4 Addressable Device Accessories

End-of-Line Resistor Assembly

The End-of-Line resistors are included with each module. Refer to the specific module documentation for specific information.

Power Supervision Relay

The UL listed End-of-Line power supervision relay is used to supervise the power to 4-wire smoke detectors and notification appliances.

EOL-C(R/W) Mounting Plate

The EOL-CR (red) and EOL-CW (white) are single End-of-Line resistor plates which are required for use in Canada. An ELR, which is supplied with each module and fire alarm control panel, is mounted to the EOL-C(R/W) plate. Resistors mounted to the plate can be used for the supervision of a monitor and control module circuit.

1.7 Optional Modules

The MS-9200UDLS main circuit board includes option module connectors for the following module:

4XTMF Transmitter Module

The 4XTMF provides a supervised output for local energy municipal box transmitter, alarm and trouble reverse polarity. It includes a disable switch and disable trouble LED. A jumper on the module is used to select an option which allows the reverse polarity circuit to open with a system trouble condition if no alarm condition exists. The module plugs into connectors J5 and J6 which are located near the right edge the main circuit board. When the 4XTMF module is installed, Jumper JP3, on the main circuit board, must be cut to allow supervision of the module.

1.8 Accessories

1.8.1 PS-Tools Programming Utility

The PS-Tools Programming Utility can be used to locally or remotely program the FACP directly from most IBM compatible computers (PC), running Windows™ XP (or newer). FACP program files can also be created and stored on the PC and then downloaded later to the control panel. The PK-CD Kit includes the Windows-based Programming Utility software on CD-ROM with on-line help file. A standard USB cable with male-A to male-B connectors, which must be purchased separately, is required for local connection of the PC to the USB port J12 on the FACP main circuit board. Remote programming requires that the PC have a 2400 baud (or faster) modem.

Important: *Remote modification of FACP programming requires that the panel be enabled for remote download (refer to "Remote Site Upload/Download" on page 184). Remote interrogation of panel programming, history logs, detector status, etc., is possible without enabling the remote download option.*

1.8.2 DP-9692 Dress Panel

An optional dress panel DP-9692 is available for the MS-9200UDLS (required by ULC for Canadian installations). The dress panel restricts access to the system wiring while allowing access to the key panel. A ground strap must be connected between the stud on the inside of the dress panel and the ground stud in the backbox. An optional DP-9692-LED dress panel is available for use with the ANN-LED annunciator module.

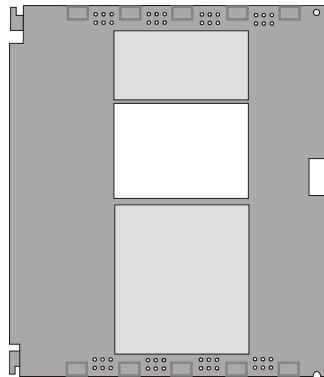

dp9200udls.cdr

1.8.3 Trim Ring

An optional Trim Ring (P/N TR-CE) is available for the FACP backbox. The Trim Ring provides a finished appearance for a semi-flush mounted panel.

1.8.4 Battery Box

BB-26

The BB-26 battery box may be used to house up to two 26 AH batteries and the CHG-75 Battery Charger. The battery box, which is red and is provided with knockouts, was designed specifically to compliment mounting below the FACP.

BB-55F

The BB-55F battery box may be used to house two 26 AH batteries, two 60 AH batteries or one 100 AH battery. When the CHG-120F is mounted in the BB-55F, two 26 AH or one 60 AH battery may also be housed in the battery box.

1.8.5 Battery Charger

1.8.5.1 CHG-75 Battery Charger

The CHG-75 is capable of charging up to 75 AH lead-acid batteries with the MS-9200UDLS FACP. The FACP battery charger must be disabled, by removing jumper JP5, when using the CHG-75. The charger and up to 26 AH batteries can be housed in the BB-26 battery box. Larger batteries and the charger can be housed in the BB-55F battery box which can be mounted up to 20 feet away from the control panel. Refer to the CHG-75 Manual for additional information.

1.8.5.2 CHG-120F Battery Charger

The CHG-120F is capable of charging up to 120 AH lead-acid batteries with the MS-9200UDLS FACP. The FACP battery charger must be disabled, by removing jumper JP5, when using the CHG-120F. The batteries and charger can be housed in the BB-55F battery box which can be mounted up to 20 feet away from the control panel. Note that when using the BB-55F for housing the charger and batteries greater than 26AH, multiple BB-55Fs are required. Refer to the CHG-120F Manual for additional information.



1.8.6 IPDACT- Internet Protocol DACT

The IPDACT is a compact, Internet Protocol Digital Alarm Communicator/Transmitter designed to allow FACP status communication to a Central Station via the internet. No telephone lines are required when using the IPDACT. Using Contact ID protocol from the FACP, the IPDACT converts the standard DACT phone communication to a protocol that can be transmitted and received via the internet. It also checks connectivity between the FACP and Central Station. Refer to the IPDACT Product Installation Document P/N 53109 for additional information.

1.8.7 ANN-BUS Annunciators/Modules



WARNING! Disconnect all sources of power (AC and DC) before installing or removing any modules or wiring.

The legacy ACS annunciators may **not** be used if new ANN-BUS annunciators are being used due to incompatible serial communication protocols.

A variety of optional devices can be connected to the FACP ANN-BUS communication circuit. ANN Series devices can be connected to the ACS (EIA-485) terminals on TB-9. Compatible devices include the following:

- ANN-80 LCD Annunciator
- ANN-S/PG Serial/Parallel Printer Interface Module
- ANN-I/O LED Driver Module
- ANN-LED Annunciator Module (alarm, trouble, supervisory LEDs)
- ANN-RLED Annunciator Module (red alarm LEDs only)
- ANN-RLY Relay Module

1.8.7.1 ANN-BUS Wiring

This section contains information on calculating ANN-BUS wire distances and the types of wiring configurations (Class B).

1.8.7.1.1 Calculating Wiring Distance for ANN-BUS Modules

The following instructions will guide the installer in determining the type of wire and the maximum wiring distance that can be used with FACP ANN-BUS accessory modules.

To calculate the wire gauge that must be used to connect ANN-BUS modules to the FACP, it is necessary to calculate the total worst case current draw for all modules on a single 4-conductor bus. The total worst case current draw is calculated by adding the individual worst case currents for each module. The individual worst case values are shown in the following table:

Model Number	Worst Case Current Draw
ANN-80 LCD Annunciator	0.040 amps
ANN-S/PG Serial/Parallel Printer Interface Module	0.040 amps
ANN-I/O LED Driver Module	0.200 amps
ANN-(R)LED Annunciator Module	0.068 amps
ANN-RLY Relay Module	0.075 amps

Note: Total worst case current draw on a single ANN-BUS cannot exceed 0.5 amp. If current draw exceeds 0.5 amps, refer to "Powering ANN-BUS Devices from Auxiliary Power Supply" on page 27.

After calculating the total worst case current draw, Table 1.1 specifies the maximum distance the modules can be located from the FACP on a single wire run. The table ensures 6.0 volts of line drop maximum. In general, the wire length is limited by resistance, but for heavier wire gauges, capacitance is the limiting factor. These cases are marked in the chart with an asterisk (*). Maximum length can never be more than 6,000 feet (1,800 m), regardless of gauge used. The formula used to generate this chart is shown in the note below.

Wiring Distance: ANN-BUS Modules to FACP				
Total Worst Case Current Draw (amps)	22 Gauge	18 Gauge	16 Gauge	14 Gauge
0.100	1,852 ft.	4,688 ft.	* 6,000 ft.	*6,000 ft.
0.200	926 ft.	2,344 ft.	3,731 ft.	5,906 ft.
0.300	617 ft.	1,563 ft.	2,488 ft.	3,937 ft.
0.400	463 ft.	1,172 ft.	1,866 ft.	2,953 ft.
0.500	370 ft.	938 ft.	1,493 ft.	2,362 ft.

Table 1.1 Wiring Distances

Note: The following formulas were used to generate the wire distance chart:

$$\text{Maximum Resistance (Ohms)} = \frac{6.0 \text{ Volts}}{\text{Total Worst Case Current Draw (amps)}}$$

$$\text{Maximum Wire Length (feet)} = \frac{\text{Maximum Resistance (Ohms)} \times 500}{\text{Rpu}}$$

(6,000 feet maximum)

where: Rpu = Ohms per 1,000 feet for various Wire Gauges (see table below)

Wire Gauge	Ohms per 1,000 feet (Rpu)
22	16.2
18	6.4
16	4.02
14	2.54

Exception: When using the ANN-RLY module, the installer must ensure that the maximum 24VDC power line drop does not exceed 0.3 volts. This results in the following wiring limitations:

Wire Gauge	Maximum Wire Length
18	312 feet
16	497 feet
14	787 feet
12	1,250 feet

Wiring Distance Calculation Example:

Suppose a system is configured with the following ANN-BUS modules:

- 3 ANN-80 Remote Fire Annunciators
- 1 ANN-S/PG Serial/Parallel Printer Interface Module

The total worst case current is calculated as follows:

ANN-80 Current Draw	= 3 X 0.040 amps	= 0.120 amps
ANN-S/PG Current Draw	= 1 X 0.040 amps	= 0.040 amps
Total Worst Case Current Draw		= 0.160 amps

Using this value and referring to the Wiring Distance Table 1.1 on page 25, it can be found that the available options are:

- ✓ 926 feet maximum using 22 Gauge wire
- ✓ 2,344 feet maximum using 18 Gauge wire
- ✓ 3,731 feet maximum using 16 Gauge wire
- ✓ 5,906 feet maximum using 14 Gauge wire

1.8.7.1.2 Wiring Configuration

Figure 1.3 illustrates the wiring between the FACP and ANN-BUS devices.

ANN-BUS and power wiring are supervised and power-limited

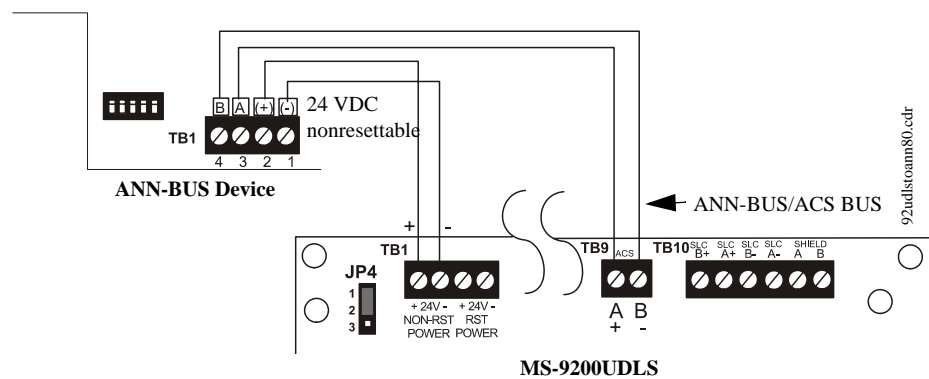

Figure 1.3 FACP wiring to ANN-BUS Device

1.8.7.1.3 Powering ANN-BUS Devices from Auxiliary Power Supply

Figure 1.4 illustrates the powering of ANN-BUS devices from an auxiliary power supply such as the FCPS-24FS6/8, when the total ANN-BUS power requirements exceed the panel's DC Power Output capability.

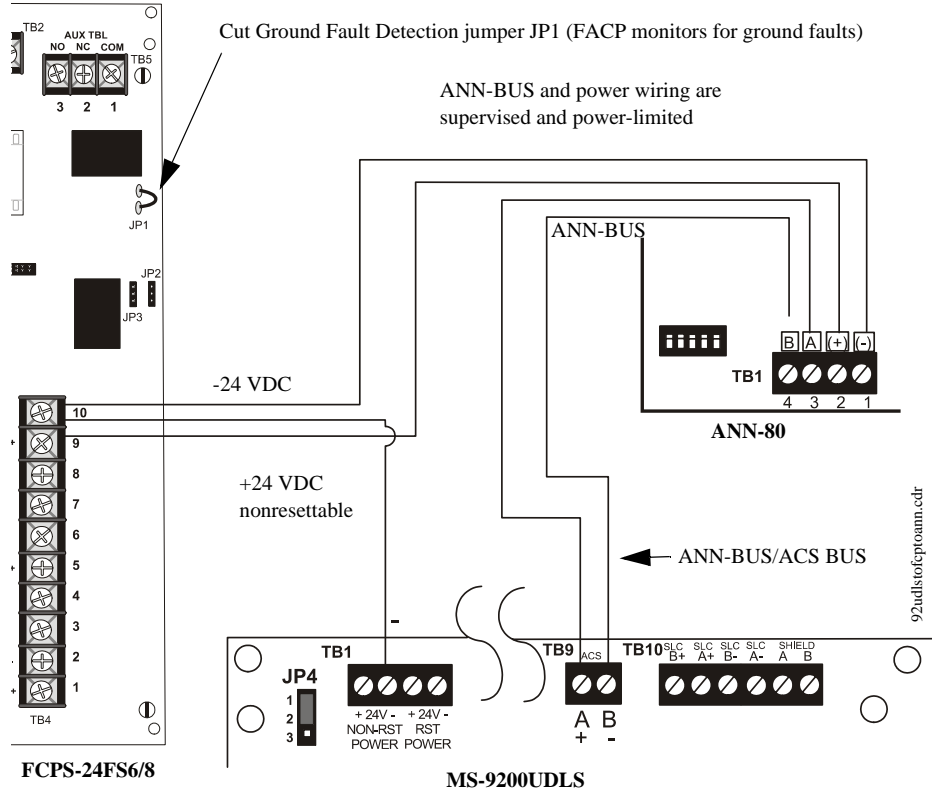

Figure 1.4 Powering ANN-BUS Devices from FCPS-24FS6/8

1.8.7.2 ANN-BUS Device Addressing

Each ANN-BUS device requires a unique address (ID Number) in order to communicate with the FACP. A 5-position DIP switch on each device is used to set this address. The address set for these devices must also be programmed at the FACP for the specific device (refer to the programming section titled "ANN-BUS Options" on page 118).

A maximum of 8 devices can be connected to the FACP ANN-BUS communication circuit. Device addresses do not need to be sequential and can be set to any number between 01 and 08. Note that 00 is not a valid address. The following table shows the DIP switch setting for each address.

Note: address (ID Number) DIP switches on some devices may have more than 5 switch positions. Unless otherwise specified in the documentation supplied with each device, switch positions 6 and above must be set to OFF.

Address	Switch 5	Switch 4	Switch 3	Switch 2	Switch 1
not valid	OFF	OFF	OFF	OFF	OFF
01	OFF	OFF	OFF	OFF	ON
02	OFF	OFF	OFF	ON	OFF
03	OFF	OFF	OFF	ON	ON
04	OFF	OFF	ON	OFF	OFF
05	OFF	OFF	ON	OFF	ON
06	OFF	OFF	ON	ON	OFF
07	OFF	OFF	ON	ON	ON
08	OFF	ON	OFF	OFF	OFF

Note: Switch 5 must be set to OFF for ANN-BUS devices to be recognized.

1.8.7.3 ANN-80 Remote Fire Annunciator

The ANN-80 Annunciator is a compact, 80 character, backlit LCD remote fire annunciator. It mimics the display on the control panel and will annunciate device type, point alarm, trouble or supervisory condition, zone assignment plus any custom alpha labels programmed into the FACP. The annunciator also provides system status LEDs to display AC Power, Alarm, Trouble, Supervisory and Alarm Silenced conditions. Additionally, the annunciator is capable of remotely performing critical system functions such as Acknowledge, Silence, Reset and Drill. Communication between the ANN-80 and FACP is accomplished over a two wire RS-485 serial interface employing the ANN-BUS communication format. The devices are powered, via two additional wires, from either the host FACP or remote UL-listed, filtered, power supply.

The function buttons, keyswitch and piezo sounder may be individually enabled and disabled through the FACP software. Refer to "ANN-80 Options" on page 130 for a description of this feature and programming information.

Note that if the keyswitch is enabled and remains in the unlocked position for more than two minutes without any buttons being pressed on the annunciator, a trouble indication will be annunciated.

1.8.7.3.1 Specifications

- Operating Voltage Range: 18 VDC to 28 VDC
- Current Consumption @ 24 VDC nominal (filtered and nonresettable):
 - ✓ Normal/Standby (no activity): 37.0 mA
 - ✓ Trouble: 39.0 mA
 - ✓ Alarm: 40.0 mA
 - ✓ AC Fail (not backlit): 15.0 mA
- For use indoors in a dry location

1.8.7.3.2 Installation

Ensure that all power (AC and DC) has been removed from the FACP before installing the annunciator.

1.8.7.3.3 Mounting

The ANN-80 can be surface or semi-flush mounted to a single, double or 4" square electrical box. Select and remove the appropriate knockout(s), pull the necessary wires through the knockouts and mount the annunciator in or on the wall depending on the type of installation desired.

The ANN-80 cover must be attached to the annunciator backplate before mounting the annunciator to the electrical box/wall. The cover cannot be reattached or removed after the annunciator has been mounted.

1.8.7.3.4 Opening/Closing Annunciator

The following procedure details the steps used to open the annunciator in order to access the terminal block and DIP switches (refer to figure below):

1. Turn the key switch to the ON (Unlocked) position by turning the key counter-clockwise
2. Push in the snap latch located on the right side of the unit while pulling the cover open
3. To close the cover, make certain the key switch is in the ON (Unlocked) position. Swing the cover closed, snapping it shut
4. Turn the key switch to the OFF (Locked) position by turning clockwise and remove the key

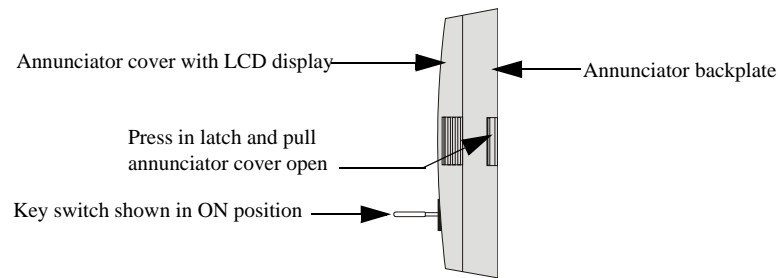

1.8.7.3.5 Wiring ANN-80 to FACP

The following steps can be used as a guide to wire the annunciator. Make certain all power has been removed from the FACP prior to annunciator installation.

1. Route wires from hole in backplate, through wiring channel and then to ANN-80 terminal block TB1

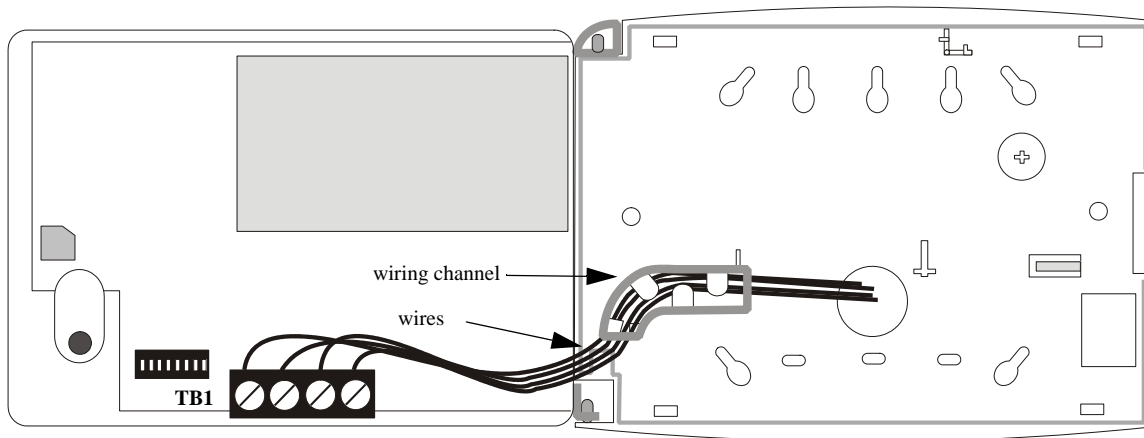

2. Remove appropriate amount of wire insulation
3. Connect the wiring from the FACP ANN-BUS to annunciator TB1 terminals 3 (A) & 4 (B). Make certain to connect A to A and B to B
4. If appropriate, connect the wiring going to the next device on the ANN-BUS to TB1 terminals 3 & 4. Make certain to connect A to A and B to B
5. Connect the wiring from the 24 VDC power source to annunciator TB1 terminals 1 (-) & 2 (+). Make certain to observe proper polarity
6. If appropriate, connect the power wiring going to the next device to terminals 1 (-) & 2 (+). Make certain to observe proper polarity
7. After all connections are made, remove extra wire from inside of annunciator by dressing it neatly through wire channel, with any excess wire pushed back through hole into electrical box

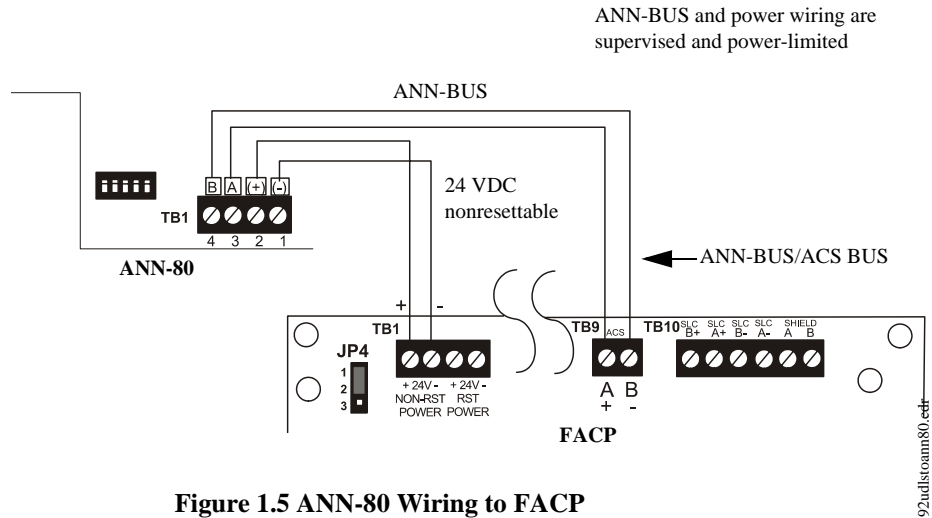

Figure 1.5 ANN-80 Wiring to FACP

The following table shows the ANN-80 connections to the MS-9200UDLS

MS-9200UDLS	ANN-80 (TB1)
Terminal GND (-) on TB1	Terminal 1 (-)
Terminal PWR (+)TB1	Terminal 2 (+)
Terminal ACS on TB9	Terminal 3 (A)
Terminal ACS on TB9	Terminal 4 (B)

Programming

Following installation and wiring of the ANN-80 LCD annunciator to the FACP, the annunciator must be added to the system via FACP programming. Refer to the programming section titled "ANN-BUS Options" on page 118 in this manual for detailed programming information. Select the LCD option for programming.

Trouble Response

If the ANN-80 is installed but the ANN-BUS is not enabled at the FACP, the ANN-80 will indicate a trouble condition by NOT turning on its AC Power indicator. The LCD will also display *Key Bus Trouble* and the piezo will sound approximately once every 10 seconds. Note that the FACP will provide no indication of an ANN-80 trouble.

To clear the ANN-80 trouble condition, enable the ANN-BUS and program the address corresponding to the address set on the ANN-80 at the FACP.

1.8.7.4 ANN-S/PG Serial/Parallel Interface Installation

The ANN-S/PG Serial/Parallel Interface module allows the connection of a remote serial or parallel printer to the FACP for a real-time log of system events, detector status reports and event history. The module is provided with a plastic enclosure for surface mounting. Proceed with the installation as described in the following:

1. Ensure that all power (AC and DC) has been removed from the FACP.
2. Connect the ANN-S/PG to the FACP as illustrated in Figure 1.6

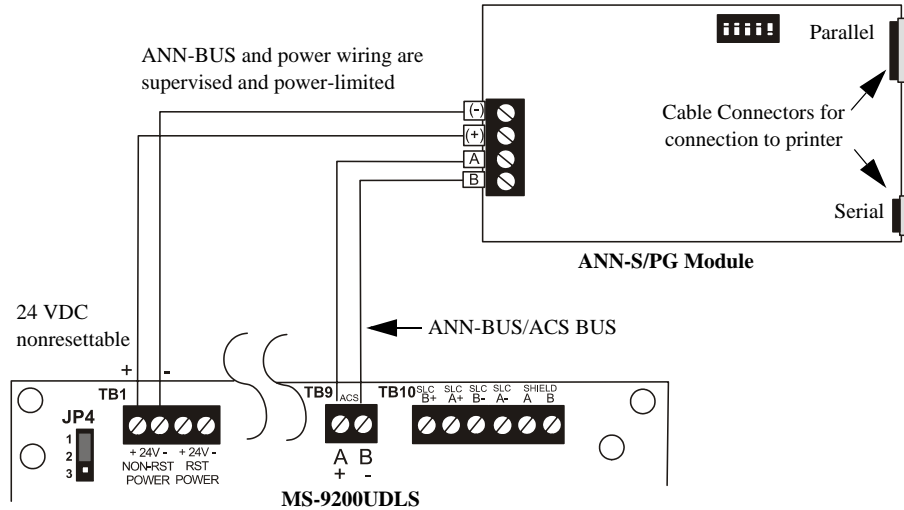

Figure 1.6 ANN-S/PG Connection to FACP

3. Using the DIP switches on the back of the ANN-S/PG module, assign an ID number (address) to the module
4. Select the address and configuration options for the ANN-S/PG module as described in the Programming section of this manual (refer to "ANN-BUS Options" on page 118)
Note that the Auto-configure feature allows the programmer to quickly bring all installed ANN-BUS modules online (refer to "Auto-Configure" on page 128)
5. Connect a printer to the ANN-S/PG Parallel or Serial connectors (refer to Figure 1.6). Only one printer can be connected.

1.8.7.4.1 Specifications

- Operating Voltage: 24 VDC
- Current (Alarm and Standby): 45 mA
- Ambient Temperature: 32°F to 120°F (0°C to 49°C)
- Max. Wiring Distance from FACP: 6,000 ft. (1,800 m)
- Mounting: Surface
- Dimensions: 6"W x 7-3/4"H x 1-7/16"D (15.2 cm W x 19.7 cm H x 3.7 cm D)
- For indoor use in a dry location only

1.8.7.4.2 PRN-6F Printer Installation

When connected to the FACP via the ANN-S/PG module, the PRN-6F prints the status changes within the control panel and time-stamps the printout with the time of day and date that the event occurred. It provides 80 columns of data on standard 9" x 11" tractor-feed paper. This section contains information on connecting a printer to the control panel and setting the printer options.

1.8.7.4.2.1 Connecting PRN-6F Printer

Remote printers require a primary AC power source. If required for the fire alarm system configuration (for example, a Proprietary Fire Alarm System), a remote printer requires a secondary power source (battery backup). Since a secondary power source is not provided as a standard feature, a separate UL-listed Uninterruptible Power Supply (UPS) should be used. The building emergency power supply may be used, as long as it meets the power continuity requirements of NFPA 72. Refer to NFPA 72 for further details.

Connect the remote printer to the FACP via the ANN-S/PG module using a standard DB-25 cable. One end of the cable will plug into the DB-25 connector on the PRN printer and the other end plugs into the parallel connector on the ANN-S/PG module. Note that the 9-pin DB-9 port on the ANN-S/PG is used to connect a serial printer. The 25-pin port is used for a Centronics parallel printer cable. Connect either a serial or parallel printer, but not both at the same time.

1.8.7.4.2.2 Setting Printer Options

Refer to the documentation supplied with the PRN-6F printer for instructions on using the printer menu controls. Set the printer options (under the menu area) as shown in the following table:

Table 1.2 PRN Setup Options

Option	Setting	Option	Setting
Font	HS Draft	CPI	10CPI
LPI	6 LPI	Skip	0.5
ESC Character	ESC	Emulate	Epson FX-850
Bidirectional Copy	ON	I/O	
CG-TAB	Graphic	Buffer	40K
Country	E-US ASCII	Serial	
Auto CR	OFF	Baud	9600 or 2400
Color Option	Not Installed	Format	7 Bit, Even, 1 Stop
Formien		Protocol	XON/XOFF
Lines	6LPI=60	Character Set	Standard
Standard	Exec 10.5	SI.Zero	On
		Auto LF	On
		PAPER	
		BIN 1	12/72"
		BIN 2	12/72"
		SINGLE	12/72"
		PUSH TRA	12/72"
		PULL TRA	12/72"
		PAP ROLL	12/72"

1.8.7.5 ANN-I/O LED Driver Module

The ANN-I/O is an LED driver module that can be used in a wide variety of applications, including as an interface with most customized graphic annunciators. The ANN-I/O can drive up to 40 LEDs. The module is provided with a plastic enclosure for mounting inside the annunciator or accessory box. The following sections describe hardware installation. Refer to the section titled "ANN-BUS Options" on page 118 for programming information.

1.8.7.5.1 ANN-I/O Board Layout

Figure 1.7 illustrates the ANN-I/O board showing locations of screw terminals for connection to the FACP, pin connectors for connecting LEDs and the DIP switch for selecting the ANN-BUS ID number.

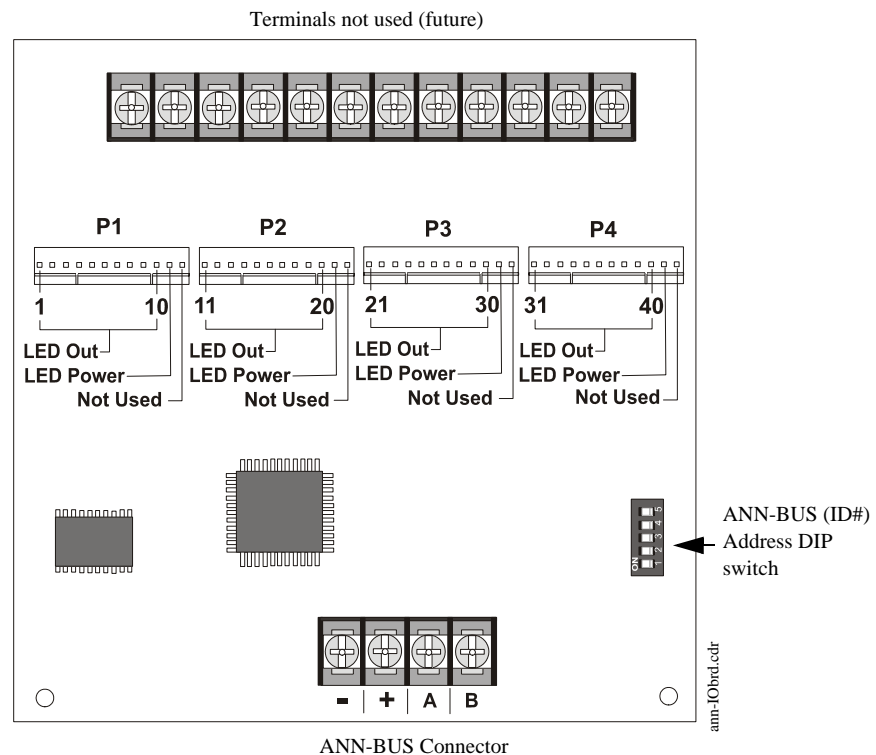

Figure 1.7 ANN-I/O Board Layout

1.8.7.5.2 Specifications

- Max. ANN-BUS Voltage: 28 VDC
- Max. Current:
 - ✓ Alarm: 200 mA
 - ✓ Standby: 35 mA
 - ✓ Each LED: 10 mA
- Operating Temperature: 32°F to 120°F (0°C to 49°C)
- For indoor use in a dry location only

1.8.7.5.3 ANN-I/O Connection to FACP

The ANN-I/O connects to the FACP via the ANN-BUS as illustrated in Figure 1.8. After the ANN-I/O is connected to the panel, it must be added to the system via FACP programming. Refer to the section titled "ANN-I/O Options" on page 120.

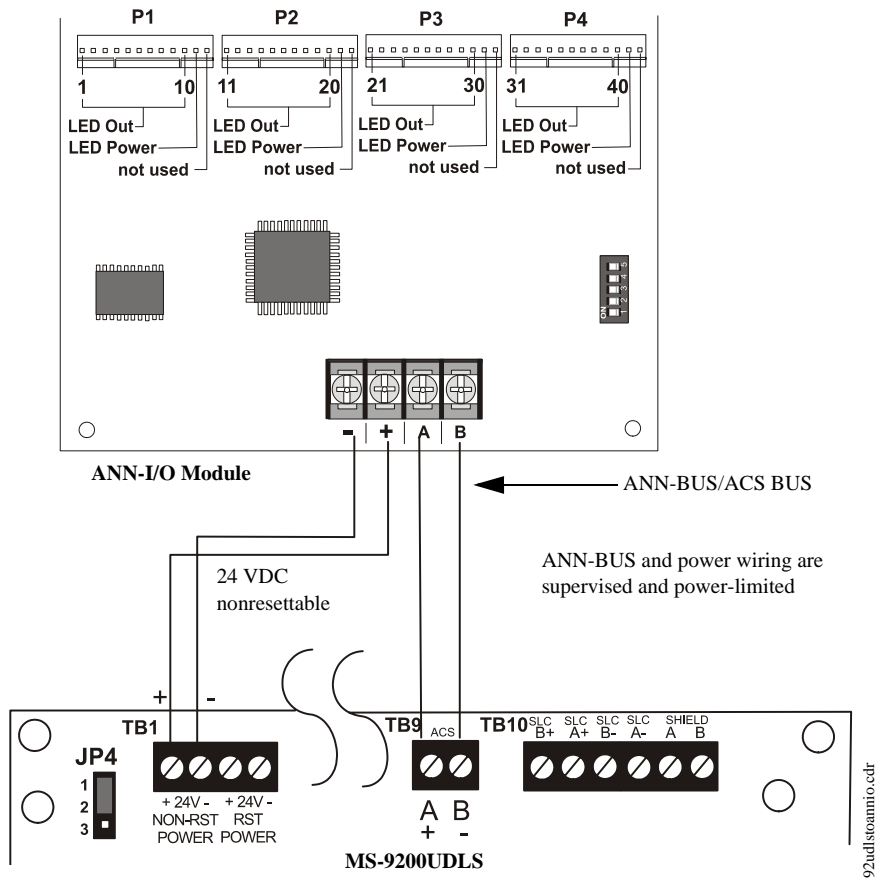

Figure 1.8 ANN-I/O Connection to FACP

1.8.7.5.4 ANN-I/O Module LED Wiring

There are four 12-pin connectors on the ANN-I/O module for connecting LEDs. Each set of 10 LEDs get their power from Pin 11 of the corresponding connector. Internal resistors are sized so that there is approximately 10 mA of current for each LED. No series resistors are required. LED outputs can be mapped to output circuits. Refer to the programming section titled "ANN-I/O Options" on page 120 of this manual.

The LEDs are wired as illustrated in Figure 1.9. Note that the illustration depicts only connectors P1 and P2. Wiring is identical for P3 (LEDs 21-30) and P4 (LEDs 31-40).

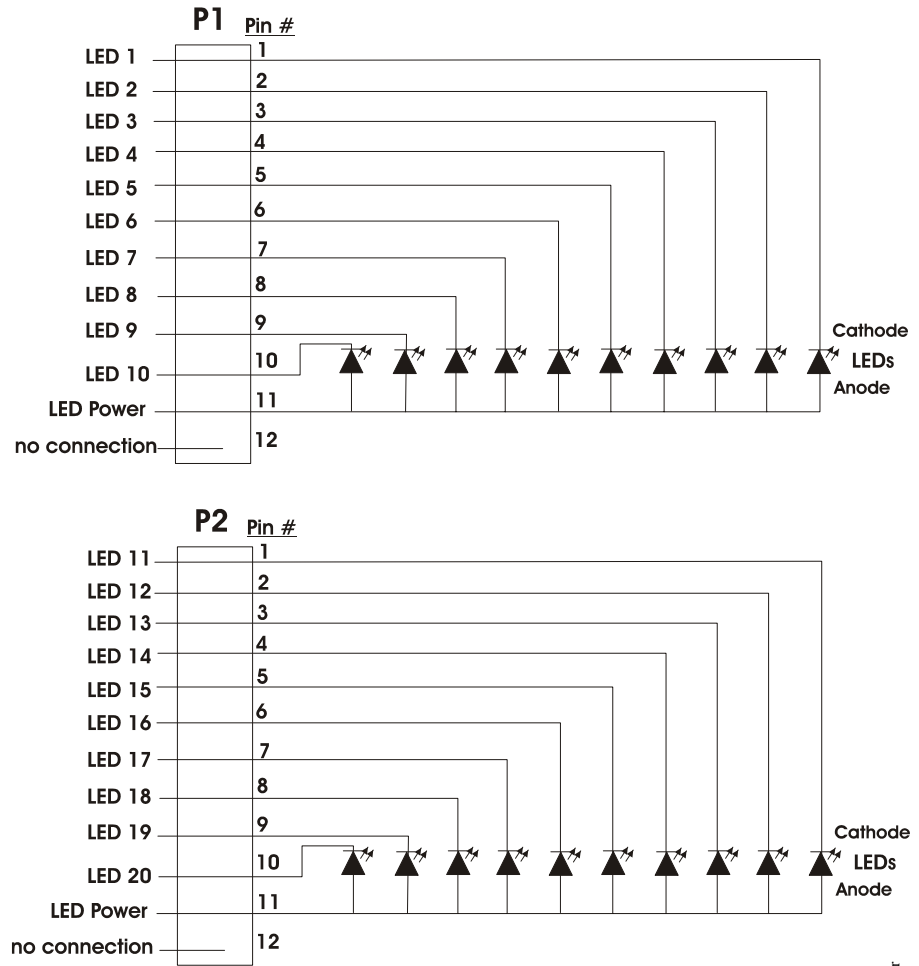

Figure 1.9 ANN-I/O Board Layout

ann1-0leds.cdr

1.8.7.6 ANN-LED Annunciator Module

The ANN-LED and ANN-RLED annunciator modules provide LED annunciation of general system faults and input zones/points when used with a compatible FACP. The ANN-LED module provides alarm (red), trouble (yellow) and supervisory (yellow) indication for up to ten input zones or addressable points. The ANN-LEDR provides alarm (red) indication for up to 30 input zones or addressable points. Multiple ANN-(R)LED modules may be used for full system coverage.

1.8.7.6.1 ANN-LED Board Layout

Figure 1.10 illustrates the ANN-LED board showing locations of screw terminals for connection to the FACP and the DIP switches for selecting the ANN-BUS ID number.

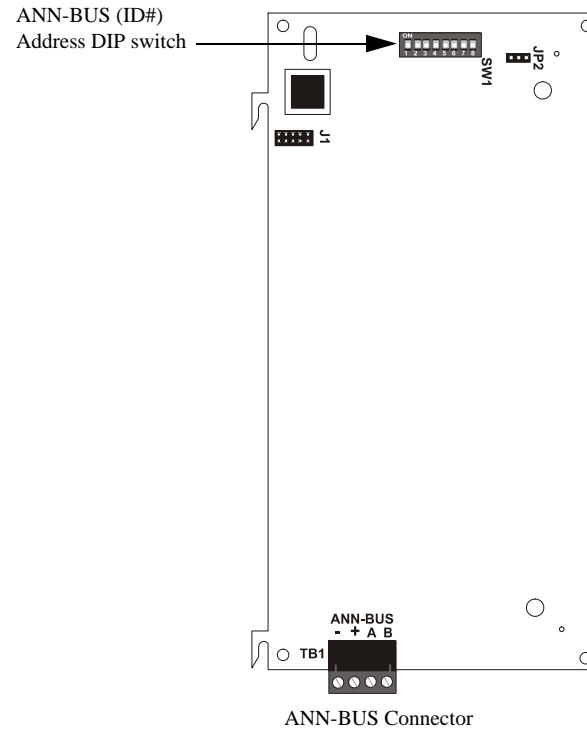

Figure 1.10 ANN-LED Board Layout

1.8.7.6.2 Specifications

- Max. ANN-BUS Voltage: 24 VDC
- Max. Current:
 - ✓ Alarm: 68 mA
 - ✓ Standby: 28 mA
- Operating Temperature: 32° F to 120° F (0° C to 49° C)
- For indoor use in a dry location only

1.8.7.6.3 Mounting/Installation

The ANN-LED Module is supplied mounted to the DP-9692LED Dress Panel. Install the dress panel as described in the documentation supplied with the DP-9692LED.

1.8.7.6.4 ANN-LED Connection to FACP

Figure 1.10 illustrates the ANN-LED board showing locations of screw terminals for connection to the FACP and the DIP switches for selecting the ANN-BUS ID number.

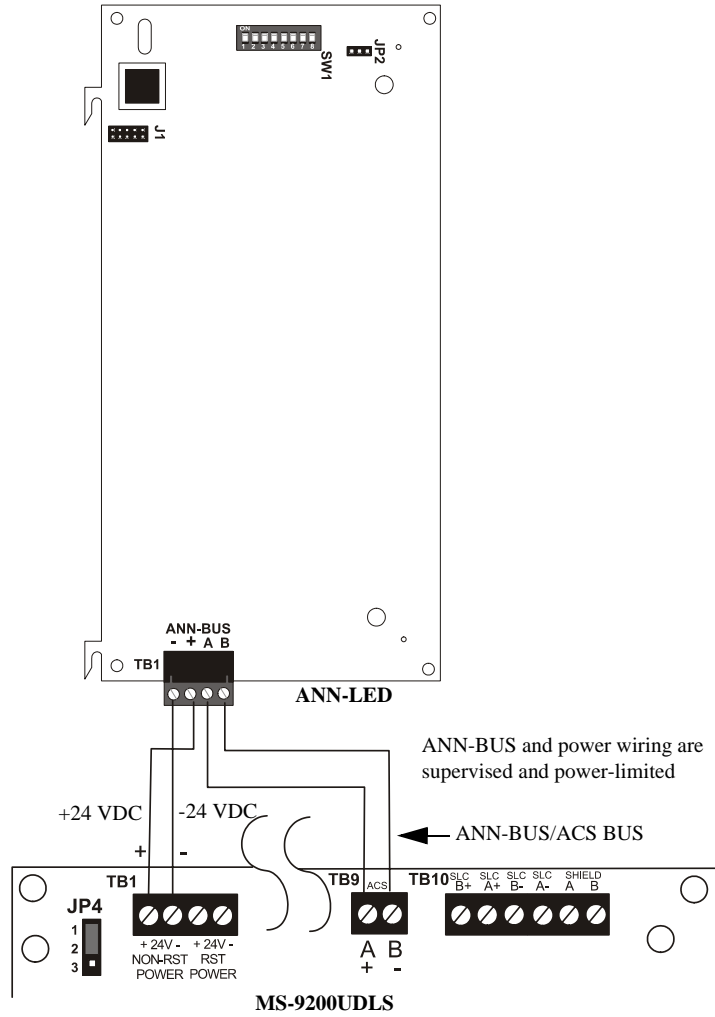

Figure 1.11 ANN-LED Connection to FACP

1.8.7.7 ANN-RLY Annunciator Module

The ANN-RLY relay module provides 10 programmable Form-C relays when used with a compatible FACP.

1.8.7.7.1 ANN-RLY Board Layout

Figure 1.10 illustrates the ANN-RLY board showing locations of screw terminals for connection to the FACP and the DIP switches for selecting the ANN-BUS ID number.

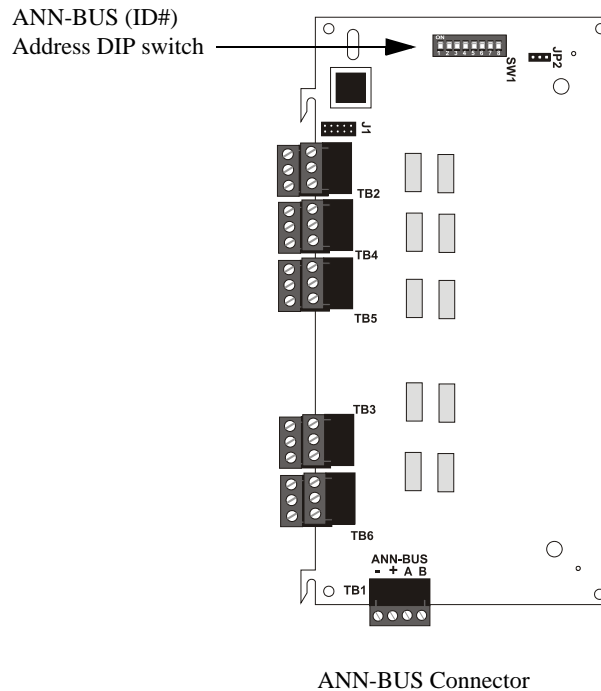

Figure 1.12 ANN-RLY Board Layout

1.8.7.7.2 Specifications

- Operating Voltage: 24 VDC
- Max. Current:
 - ✓ Alarm: 75 mA
 - ✓ Standby: 15 mA
- Operating Temperature: 32° F to 120° F (0° C to 49° C)
- For indoor use in a dry location only

1.8.7.7.3 Mounting/Installation

The ANN-RLY relay module can be mounted inside the FACP main circuit board chassis. Refer to documentation supplied with the relay module.

1.8.7.7.4 ANN-RLY Connection to FACP

Figure 1.13 illustrates the ANN-RLY board showing locations of screw terminals for connection to the FACP and the DIP switches for selecting the ANN-BUS ID number.

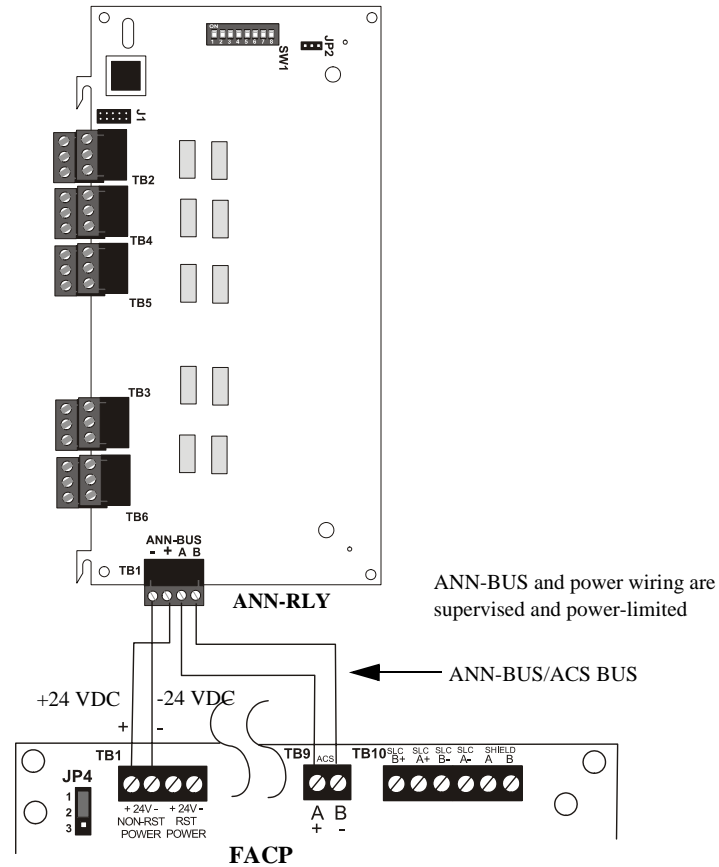

Figure 1.13 ANN-RLY Connection to FACP

1.8.7.8 ANN-BUS Audio Panel Control



WARNING! Disconnect all sources of power (AC and DC) before installing or removing any wiring.

The FACP is capable of providing automated activation of the ACC-25/50(ZS/T) zoned system speaker circuits. To do this, the FACP must be enabled to communicate with the ACC-25/50ZS Audio Panel over the ANN-BUS (refer to "ANN-BUS Enabled" on page 118). This is accomplished by programming the Audio Panel ANN-BUS address into the FACP (refer to "Modules Installed" on page 118). For details on setting the ANN-BUS address and programming the audio panel, refer to the ACC-25/50ZS Series Audio Panel manual (document #51889).

The ACC-25/50ZS Series audio panel connects to the FACP via the ACS/ANN-BUS communication circuit. Zones 33 - 56 on the FACP correspond to the ACC-25/50ZS Series audio circuits 1 - 24. Zone 32 on the FACP serves as the All-Call zone and will activate all audio panel output circuits. The programmer can select which of the five audio messages at the audio panel will play when an FACP input zone goes into alarm (refer to "Zone Message" on page 96). The message will play over the corresponding audio panel output circuit.

Examples:

- FACP Input programmed to Zone 33 goes into alarm, the programmed message for Zone 33 [Message 1, 2, 3, 4 or 5] will play over the ACC-25/50ZS Series output circuit 1 which corresponds to FACP Zone 33.
- FACP Input programmed to Zone 1 and Zone 34 (Zone 1 is programmed for a Message [1, 2, 3, 4 or 5] and Zone 34 is programmed for No Message) goes into alarm, the programmed message for Zone 1 will play over the ACC-25/50ZS Series output circuit 2 which corresponds to FACP Zone 34.
- If two or more input zones are active at the same time, the highest priority message will turn on (Message 1 is highest priority and Message 5 is lowest) and play over the corresponding audio panel output circuit(s).
- Zone 32 is an All-Call zone. All audio panel output circuits will turn on if Zone 32 is activated and its programmed message will play (or the highest priority message currently being played).

A fault at the ACC-25/50ZS Series panel will cause the FACP to indicate a System Trouble and the display will indicate a Voice Evac Fault.

The only connection between the FACP and ACC-25/50ZS Series audio panel is a pair of communication wires connected between the A(+)/B(-) terminals on TB9 of the FACP and TB1 terminals 2 & 3 of the ACC-ZPMK module on the audio panel.

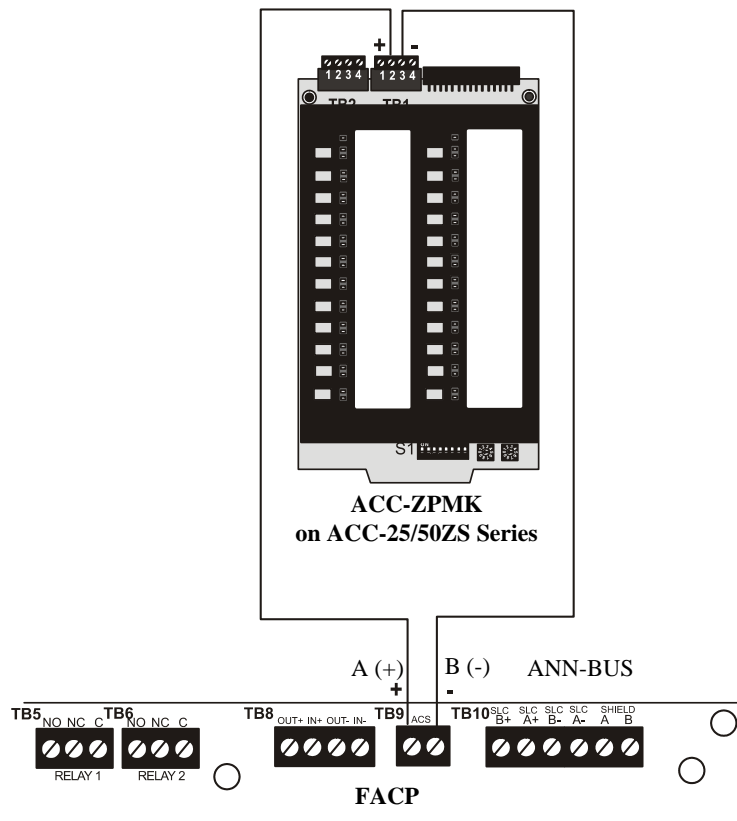

Figure 1.1 FACP Connection to ACC-25/50ZS Series Audio Panel

1.8.8 Legacy ACS Series LED Zone Type Annunciators



WARNING! Disconnect all sources of power (AC and DC) before installing or removing any modules or wiring.

The legacy ACS annunciators may **not** be used if new ANN-BUS annunciators are being used due to incompatible serial communication protocols.

The legacy ACS Series Annunciators remotely display alarm and trouble status as well as system status. In addition, they can provide remote Acknowledge, Silence, Reset and Drill functions. For more detailed information, refer to the appropriate annunciator manual. Following is a list of annunciators which can be used with the MS-9200UDLS.



Reference
Manual

- **ACM-16ATF*** Annunciator Control Module annunciates 16 zones with 16 red alarm LEDs and 16 yellow trouble LEDs. In addition, it has a System Trouble LED, an On Line/Power LED and a local piezo sounder.
- **AEM-16ATF** Annunciator Expander Module annunciates 16 zones with 16 red alarm LEDs and 16 yellow trouble LEDs
- **ACM-32AF*** Annunciator Control Module annunciates 32 alarm zones with 32 red LEDs. In addition, it has a System Trouble LED, an On Line/Power LED and a local piezo sounder. It also has a switch for local piezo silence.
- **AEM-32AF** Annunciator Expander Module annunciates 32 alarm zones with 32 red LEDs

* *In Canada, the color red must be used to indicate active alarm inputs. Yellow indicates supervisory, burglary or trouble signals. Green indicates the presence of power, or an activated output.*

LCD-80F Remote Fire Annunciator

The LCD-80F annunciator is an 80-character backlit LCD remote fire annunciator that is capable of displaying English language text. Communications between the control panel and the annunciator is accomplished over a serial interface employing the EIA-485 communication standard. Up to 32 LCD-80F annunciators may be connected to the EIA-485 circuit. The annunciators may be powered from the host FACP or a remote UL listed filtered power supply such as the FCPS Series. For more detailed information, refer to the LCD-80F manual.



Reference
Manual

LDM Series Lamp Driver Modules (Graphic Annunciator)

The LDM Series Lamp Driver Modules, which consist of the LDM-32F master and LDM-E32F expander modules, are used to provide an interface to a custom graphic LED annunciator.



Reference
Manual

Legacy ACM-8RF Relay Control Module

The ACM-8RF module provides eight Form-C relays with contacts rated for 5 amps.

1.9 Getting Started

The following is a brief summary of the minimal steps involved in bringing an MS-9200UDLS on-line:

- Install Backbox and Main Circuit Board (refer to "Mounting Backbox" on page 45)
- Address and Install Intelligent Devices (refer to the SLC Wiring Manual)
- Enter Autoprogramming (refer to "Autoprogram" on page 64)
- Resolve Programming Conflicts
- Go to Point Program to Enter Specific Data (refer to "Point Program" on page 65). Use the right and left arrow keys to navigate between devices.

1.10 Telephone Requirements and Warnings

1.10.1 Telephone Circuitry

Ringer Equivalence Number (REN) = 0.0B
AC Impedance: 10.0 Mega Ohm
Complies with FCC Part 68
Mates with RJ31X Male Connector
Supervision Threshold: loss of phone line voltage for 2 minutes

The REN is used to determine the quantity of devices which may be connected to the telephone line. Excessive RENs on the telephone line may result in the devices not ringing in response to an incoming call. In most, but not all areas, the sum of the RENs should not exceed five (5.0). To be certain of the number of devices that may be connected to the line as determined by the total RENs, contact the telephone company to determine the maximum REN for the calling area.

1.10.2 Digital Communicator

Before connecting the control panel to the public switched telephone network, the installation of two RJ31X jacks is necessary. If trouble is experienced with this equipment, for repair or warranty information, please contact:

Manufacturer: Fire•Lite Alarms, Inc.
One Fire-Lite Place
Northford, CT 06472
(203) 484-7161

Product Model Number: **MS-9200UDLS**
FCC Registration Number: **US:1W6AL11B9200UDLS**
Ringer Equivalence: **1.1B**

*Note: This equipment complies with Part 68 of the FCC rules and the requirements adopted by the ACTA. On the inside of the FACP door is a label that contains, among other information, a product identifier in the format **US:AAAEQ##TXXXX**. If requested, this number must be provided to the telephone company.*

Alarm dialing equipment must be able to seize the telephone line and place a call in an emergency situation. It must be able to do this even if other equipment (telephone, answering system, computer modem, etc.) already has the telephone line in use. To do so, alarm dialing equipment must be connected to a properly installed RJ31X jack that is electrically in series with and ahead of all other equipment attached to the same telephone line. If there are any questions concerning these instructions, consult the telephone company or a qualified installer about installing the RJ31X jack and alarm dialing equipment. Refer to "Digital Communicator" on page 54 for an illustration of the proper installation of this equipment.

Important! The DACT must not be used to dial a phone number that is call-forwarded.

1.10.3 Telephone Company Rights and Warnings

The telephone company, under certain circumstances, may temporarily discontinue services and/or make changes in its facilities, services, equipment or procedures which may affect the operation of this control panel. However, the telephone company is required to give advance notice of such changes or interruptions.

If the control panel causes harm to the telephone network, the telephone company reserves the right to temporarily discontinue service. Advance notification will be provided except in cases when advance notice is not practical. In such cases, notification will be provided as soon as possible. The opportunity will be given to correct any problems and to file a complaint with the FCC if you believe it is necessary.

DO NOT CONNECT THIS PRODUCT TO COIN TELEPHONE, GROUND START, OR PARTY LINE SERVICES.

When the control panel activates, premise phones will be disconnected.

Two separate phone lines are required. Do not connect both telephone interfaces to the same telephone line.

The control panel must be connected to the public switched telephone network upstream (as first device) of any private telephone system at the protected premises.

A plug and jack used to connect this equipment to the premises wiring and telephone network must comply with the applicable FCC Part 68 rules and requirements adopted by ACTA. This equipment is designed to be connected to the telephone network or premises wiring using a compliant RJ31X male modular plug and compatible modular jack that is also compliant.

1.10.4 For Canadian Applications

The following is excerpted from CP-01 Issue 5:

NOTICE: The Industry Canada (IC) label identifies certified equipment. This certification means that the equipment meets certain telecommunications network protective, operational and safety requirements as prescribed in the appropriate Terminal Equipment Technical Requirements document(s). The Department does not guarantee the equipment will operate to the users's satisfaction.

Before installing this equipment, users should ensure that it is permissible to be connected to the facilities of the local telecommunications company. The equipment must also be installed using an acceptable method of connection. The customer should be aware that compliance with the above conditions may not prevent degradation of service in some situations.

Repairs to certified equipment should be made by an authorized Canadian maintenance facility designated by the supplier. Any repairs or alterations made by the user to this equipment, or equipment malfunctions, may give the telecommunications company cause to request the user to disconnect the equipment.

Users should ensure, for their own protection, that the electrical ground connections of the power utility, telephone lines and internal metallic water pipe system, if present, are connected together. This precaution may be particularly important in rural areas.

CAUTION

Users should not attempt to make such connections themselves, but should contact the appropriate electric inspections authority, or electrician.

“The Ringer Equivalence Number (REN) assigned to each terminal device provides an indication of the maximum number of terminals allowed to be connected to a telephone interface. the termination of an interface may consist of any combination of devices subject only to the requirement that the sum of the REN of all devices does not exceed 5.”

DOC Compliance - “This digital apparatus does not exceed the Class A limits for radio noise emissions from digital apparatus set out in the Radio Interference Regulations of the Canadian Department of Communications.”

Representative: NOTIFIER/FIRE•LITE, CANADA
10 Whitmore Road
Woodbridge, Ontario L4L 7Z4
Phone: (905) 856-8733
FAX: (905) 856-9687

IC Certificate Number:

Ringer Equivalence Number (REN): 1.3B

Load Number: 2

SECTION 2

Installation

The cabinet may be either semi-flush or surface mounted. The cabinet mounts using two key slots and two 0.250" (6.35 mm) diameter holes located in the backbox. The key slots are located at the top of the backbox and the two securing holes at the bottom.

Carefully unpack the system and check for shipping damage. Mount the cabinet in a clean, dry, vibration-free area where extreme temperatures are not encountered. The area should be readily accessible with sufficient room to easily install and maintain the panel. Locate the top of the cabinet approximately 5 feet (1.5 m) above the floor with the hinge mounting on the left. Determine the number of conductors required for the devices to be installed. Sufficient knockouts are provided for wiring convenience. Select the appropriate knockout(s) and pull the conductors into the box. All wiring should be in accordance with the National and/or Local codes for fire alarm systems.

2.1 Mounting Backbox



The circuit board contains static-sensitive components. Always ground yourself with a proper wrist strap before handling any boards so that static charges are removed from the body. Use static suppressive packaging to protect electronic assemblies.

To prevent damage to the circuit board and to facilitate backbox mounting, the chassis with main circuit board and transformer can be easily removed. Loosen the two 3/8" nuts securing the top flanges of the chassis, then slide the chassis up to free it from the lower tabs. Place the chassis assembly inside the supplied anti-static bag and store in a safe location until it can be reinstalled in the backbox.



See Page

- ✓ Mark and predrill hole in the wall for the center top keyhole mounting bolt using the dimensions illustrated in Figure 2.3 on page 47
- ✓ Install center top fastener in the wall with the screw head protruding
- ✓ Place backbox over the top screw, level and secure
- ✓ Mark and drill the left and right upper and lower mounting holes
Note: outer holes (closest to sidewall) are used for 16" O.C. stud mounting
- ✓ Install remaining fasteners and tighten

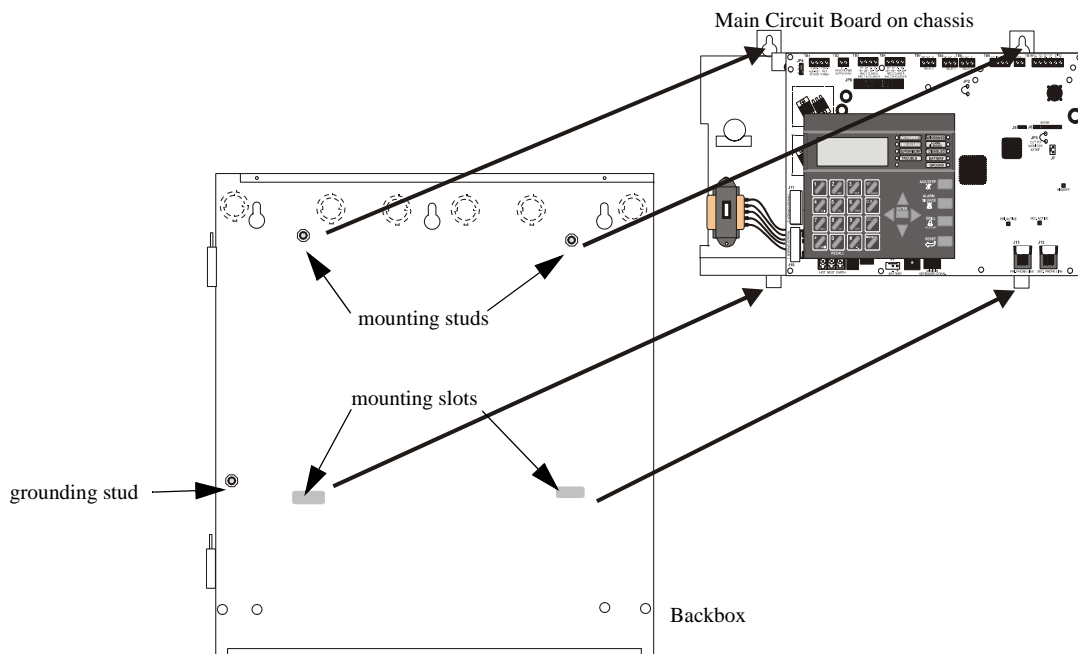

Figure 2.1 MS-9200UDLS Chassis Removal

92udchassisinboxedr

2.2 Mounting Optional Transformer/Remounting Chassis

One XRM-24B(E) transformer is supplied standard with the control panel. An optional second XRM-24B(E) transformer can be ordered and installed to provide maximum system power. Install the transformers in the locations indicated in the following illustration.

6. The standard transformer is premounted to the chassis. If the optional second transformer has been ordered, mount it to the chassis as illustrated below. The chassis does not need to be removed to install the optional transformer.
7. When the location is dry and free of construction dust, install the chassis/transformer/circuit board assembly.
8. Mount the chassis to the backbox by aligning the two mounting tabs with the slots in the backbox, then position the two mounting hole tabs over the studs with nuts located in the upper portion of the backbox.
9. Slide the tabs located on the bottom of the chassis into the mounting slots in the backbox by pressing the chassis down.
10. Secure the chassis to the backbox by tightening the two mounting nuts (#10-32) at the top, and to ensure proper grounding, use a 3/8" nut driver or socket.
11. If the main circuit board is not already attached to the chassis, install it by positioning the ten mounting holes over the studs on the chassis and secure with the supplied screws.
12. Connect the Standard XRM-24B(E) Transformer plug to Transformer 1 Connector J10 on the FACP main circuit board
13. Connect the Optional XRM-24B(E) Transformer plug to Transformer 2 Connector J11 on the FACP main circuit board.
14. Complete the installation as detailed in the following sections.

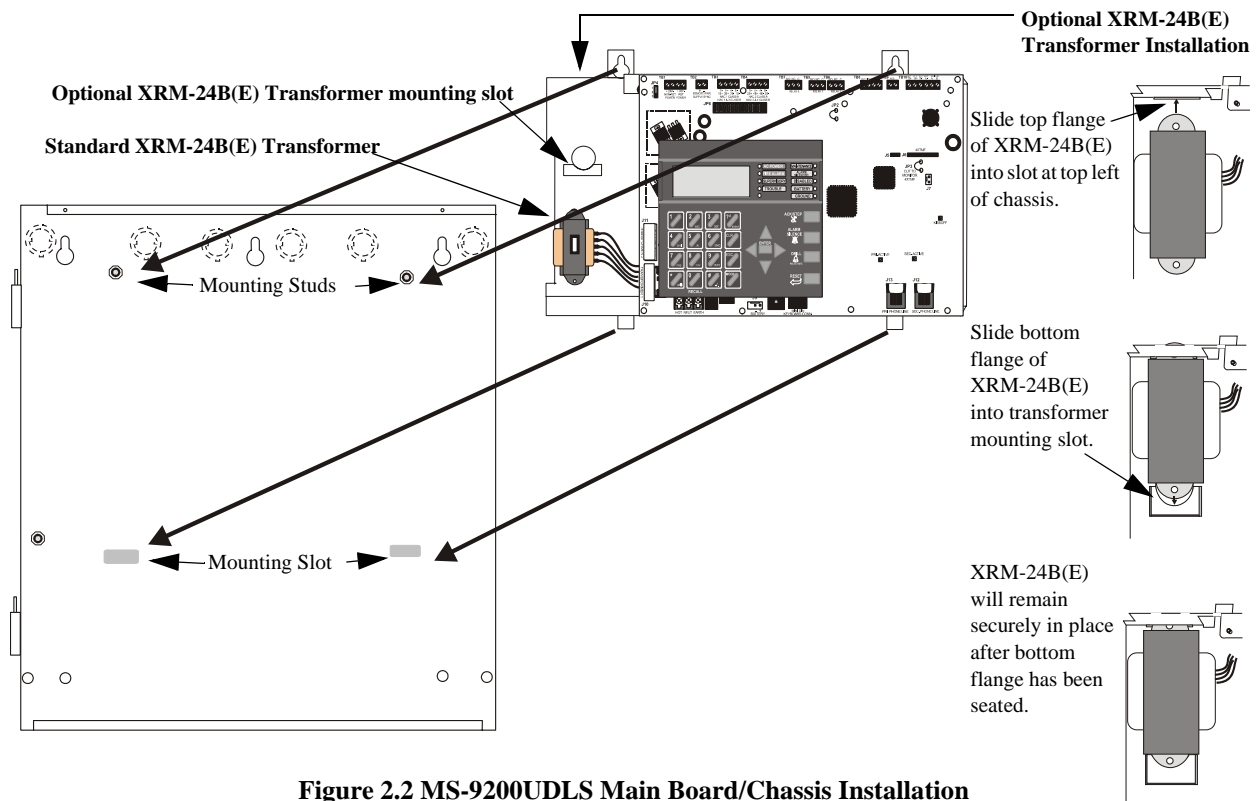

Figure 2.2 MS-9200UDLS Main Board/Chassis Installation

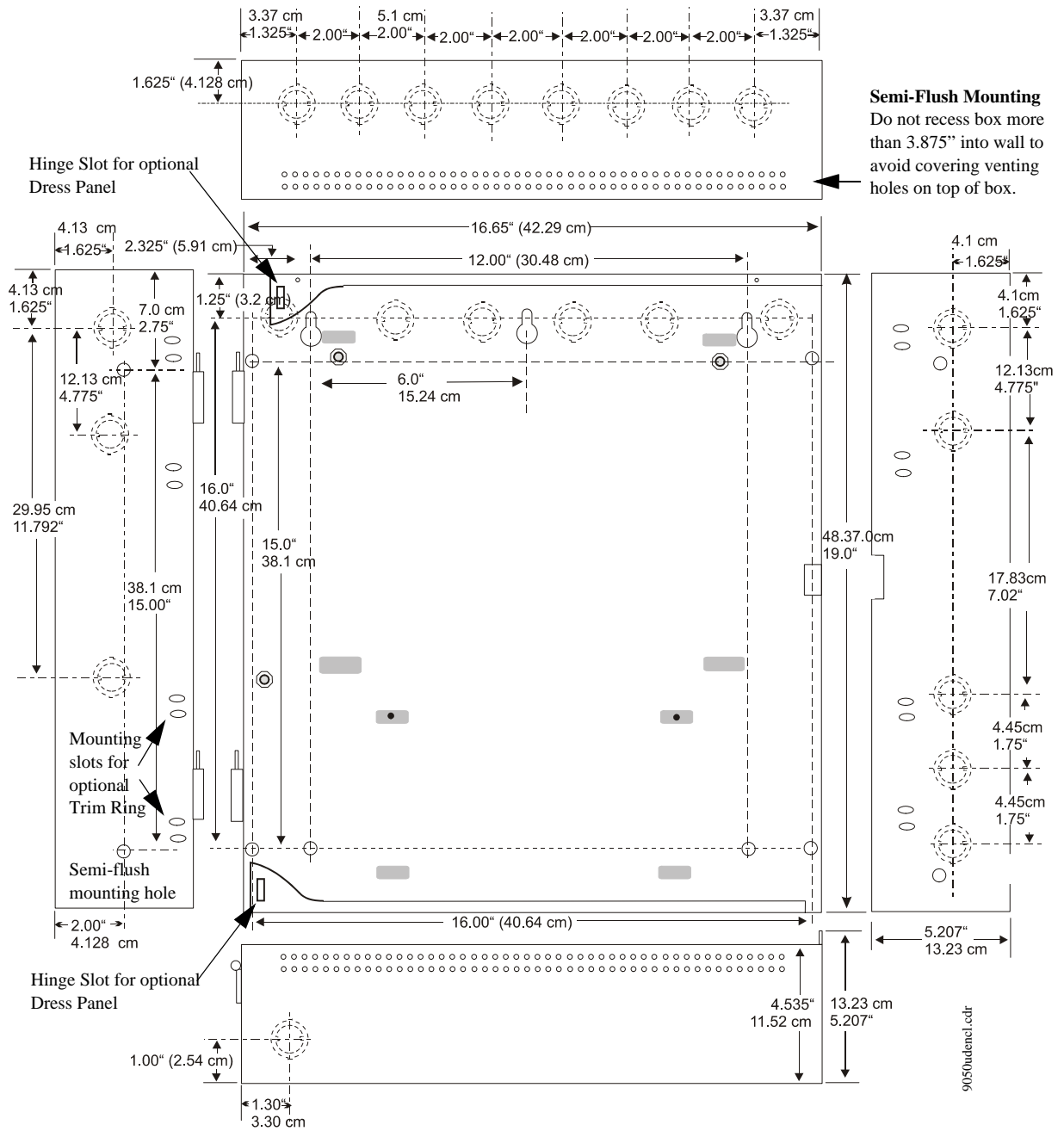
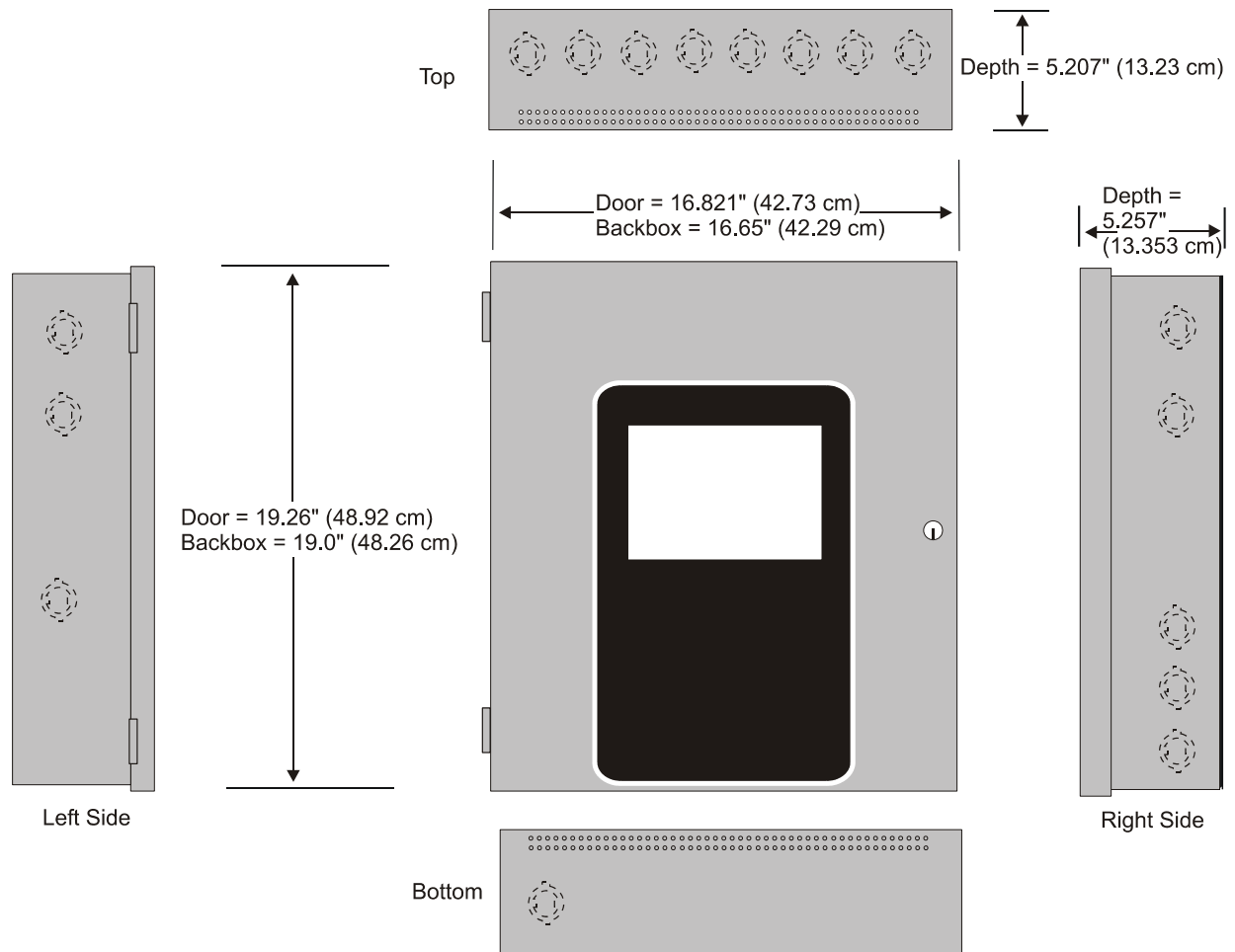

Figure 2.3 MS-920UDLS Cabinet Mounting



9050udcab.cdr

Figure 2.4 MS-9200UDLS Cabinet Dimensions

An optional Trim Ring (P/N TR-CE-) is also available for semi-flush mount installations.

2.3 Power



WARNING: Several different sources of power can be connected to this panel. Disconnect all sources of power before servicing. The panel and associated equipment may be damaged by removing and/or inserting cards, modules or interconnecting cables while this unit is energized.

2.3.1 AC Power and Earth Ground Connection

Primary power required for the FACP is 120 VAC, 60 Hz, 3.0 amps for the MS-9200UDLS or 240 VAC, 50 Hz, 1.5 amps for the MS-9200UDLSE. Overcurrent protection for this circuit must comply with Article 760 of the National Electrical Code (NEC) and/or local codes. Use 14 AWG (2.00 mm²) or larger wire with 600 volt insulation rating. Make certain that the AC mains circuit breaker is off before wiring any connections between the mains and the control panel. Connect wiring from the AC mains to TB11 on the FACP, being careful to observe proper connections.

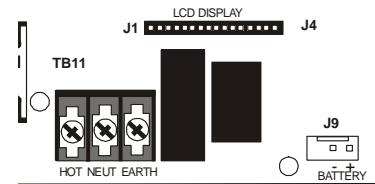

Connect a wire from the grounding stud in the cabinet to a known solid earth ground in the building. Refer to Figure 2.1 on page 45 for location of the stud. This connection is vital for maintaining the control panel's immunity to unwanted transients generated by lightning and electrostatic discharge. Apply AC power to the panel only after the system is completely installed and visually checked. *Note that AC power must be applied to the panel before installing the battery interconnect cable (refer to the following section).*

2.3.2 Battery Power

Before connecting the batteries to the FACP, make certain that the interconnect cable between the batteries is not connected. Do not connect the interconnect cable until the system is completely installed. Observe polarity when connecting the batteries. Connect the battery cable to J9 on the main circuit board. Refer "Power Supply Calculations" on page 187, for calculation of the correct battery rating.

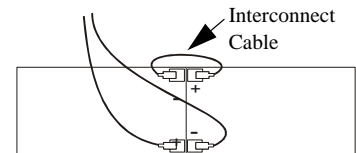

See Page



WARNING: Battery contains sulfuric acid which can cause severe burns to the skin and eyes and can destroy fabrics. If contact is made with sulfuric acid, immediately flush the skin or eyes with water for 15 minutes and seek immediate medical attention.

2.3.3 Special Application DC Power Output Connection

All Special Application DC power outputs are power-limited (refer to "UL Power-limited Wiring Requirements" on page 53).

Power-limited Resettable or Nonresettable Power
0.300 amperes max., 24 VDC nominal filtered, resettable or nonresettable power can be drawn from TB1 Terminals 1(+) and 2(-)

Power-limited Resettable Power
0.300 amperes max., 24 VDC nominal filtered, resettable power can be drawn from TB1 Terminals 3(+) and 4(-)

JP4 is used to configure TB1, Terminals 1 & 2 for:

- Nonresettable Power - jumper pins 1 and 2 of JP4 as shown
- Resettable Power - jumper pins 2 & 3 of JP4

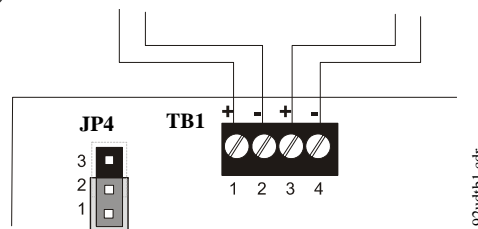

Figure 2.5 Special Application Power Outputs - 24 VDC

2.4 Relays

The FACP provides two programmable Form-C relays and one fixed fail-safe Form-C trouble relay, all with contacts rated for 2.0 amps @ 30 VDC (resistive) or 0.5 amps @ 30 VAC (resistive).

Note that relay connections may be power-limited or nonpower-limited, provided that 0.25" spacing is maintained between conductors of power-limited and nonpower-limited circuits. Refer to UL Power-limited wiring requirements.

Note that the programmable relay labeled as Relay 1 is factory default programmed as Alarm and programmable Relay 3 is factory default programmed as Supervisory. The relay labeled Relay 2 is fixed as a Trouble relay and cannot be changed. It is a fail-safe relay which will transfer on any trouble or total power failure.

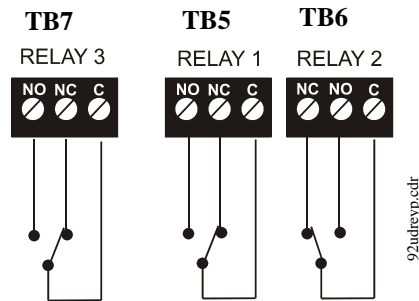

Relay contacts shown with power applied to panel and no active troubles, alarms or supervisories

Figure 2.6 Relay Terminals

2.5 Notification Appliance Circuits



See Page



Reference Manual

The control panel provides four Style Y (Class B) or two Style Z (Class A) NACs (Notification Appliance Circuits). Each circuit is capable of 2.5 amps of current. Total current in alarm for all external devices cannot exceed 6.0 amps (refer to "Calculating the System Current Draw" on page 188). Use UL listed 24 VDC notification appliances only. Circuits are supervised and power-limited. Refer to the Device Compatibility Document for a listing of compatible notification appliances. The NACs, which are located on the main circuit board, may be expanded via the FCPS Series field charger/power supplies.

The following sections describe the configuration and wiring of Style Y and Style Z Notification Appliance Circuits on the MS-9200UDLS main circuit board. The NACs are configured for Style Y (Class B) from the factory. Refer to "Configuring NACs" on page 51 for information on changing the NAC configuration to Style Z (Class A).

2.5.1 Configuring NACs

The Notification Appliance Circuits on the main circuit board are configured for Style Y (Class B) or Style Z (Class A) by properly orienting the NACKEY card in JP6 which is located at the top of the main circuit board near the NAC terminal blocks TB3 and TB4. The default configuration is for Style Y (Class B). Refer to Figure 2.7 for information on installing the NACKEY card.

- Style Z (Class A) - install NACKEY into JP6 with Class A pointing down toward circuit board as illustrated to the right.
- Style Y (Class B) - install NACKEY into JP6 with Class B pointing down toward circuit board.

NACKEY must be inserted with text side facing in toward center of main circuit board and key into key-slot as illustrated to the right. It is keyed to prevent incorrect insertion.

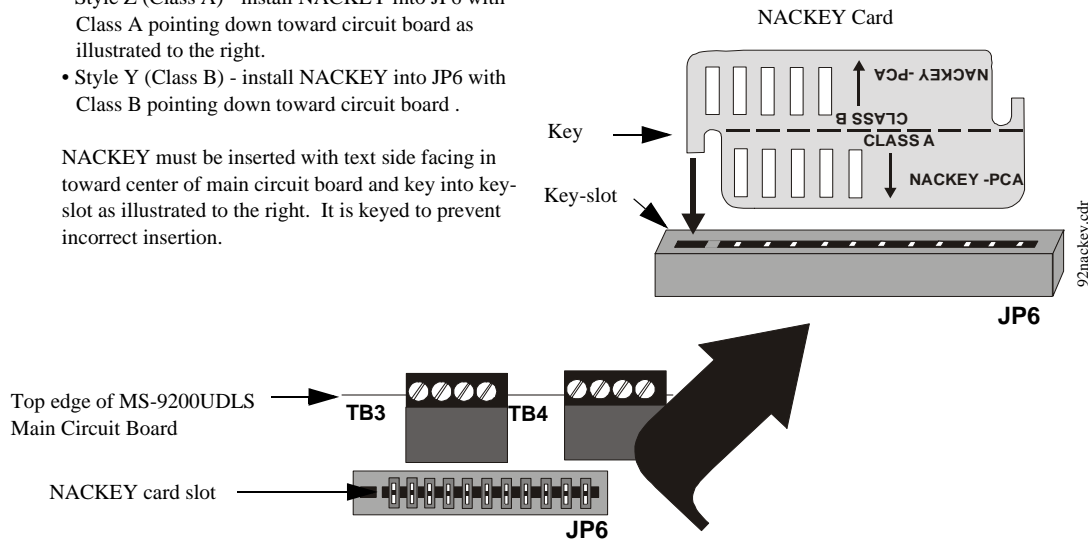

Figure 2.7 NAC Configuration Using NACKEY

2.5.2 Style Y (Class B) NAC Wiring

4 Style Y (Class B) Notification Appliance Circuits, supervised and power-limited - 4.7 kΩ, ½ watt P/N:71252 UL listed

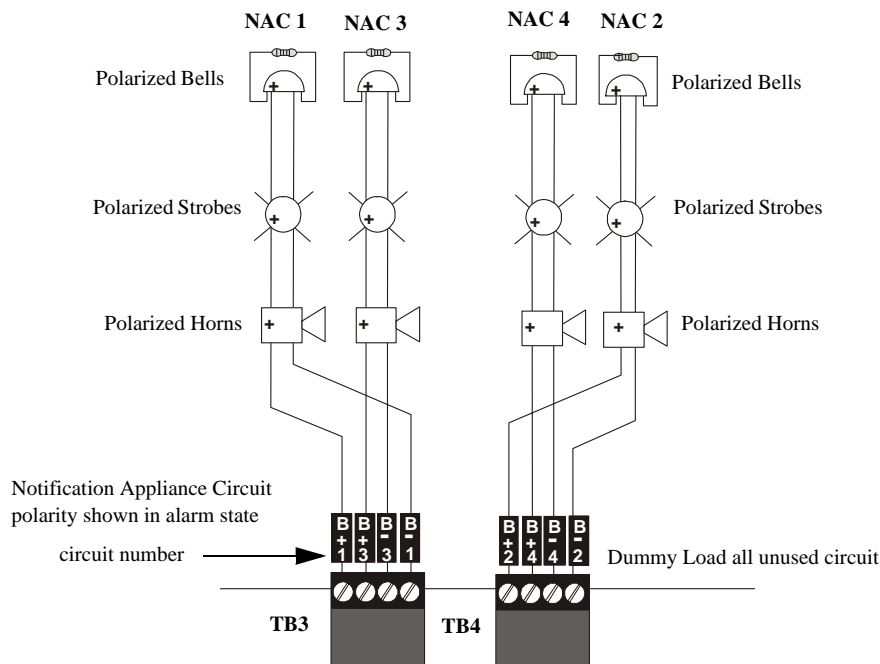

Figure 2.8 NAC Style Y (Class B) Wiring

2.5.3 Style Z (Class A) NAC Wiring

2 Style Z (Class A) Notification Appliance Circuits, supervised and power-limited

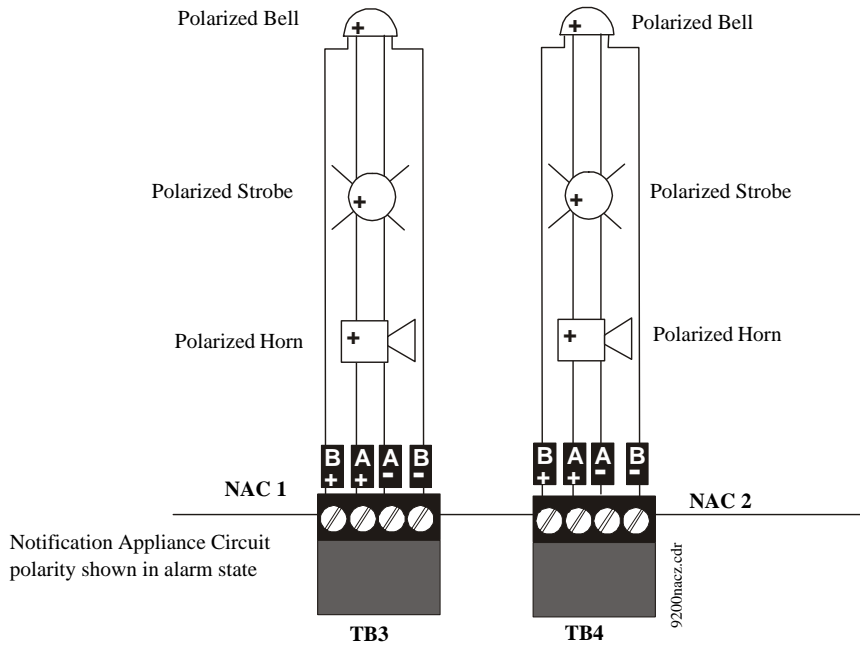

Figure 2.9 NAC Style Z (Class A) Wiring

2.6 Remote Synchronization Output

Synchronization is a feature that controls the activation of notification appliances in such a way that all devices will turn on and off at exactly the same time. This is particularly critical when activating strobes which must be synchronized to avoid random activation and a potential hazard to individuals. Devices connected directly to the control panel's NACs can be synchronized as described in "Type" on page 106.

Notification appliances connected to remote power sources may require synchronization with the FACP's devices. This can be accomplished by connecting the Remote Synchronization Output from TB2 of the MS-9200UDLS to a compatible sync input of a power supply such as the FCPS-24FS6/8. The 24 VDC, 40 mA signal from TB2 follows, that is mimics, the signal on NAC1. This allows the devices connected to the power supply to be synchronized with the devices connected to NAC1 on the FACP.

The Remote Synchronization Output is power-limited and supervised (refer to "UL Power-limited Wiring Requirements" on page 53). A 4.7 kΩ ELR resistor must be connected to the end of the wiring at the remote power supply.

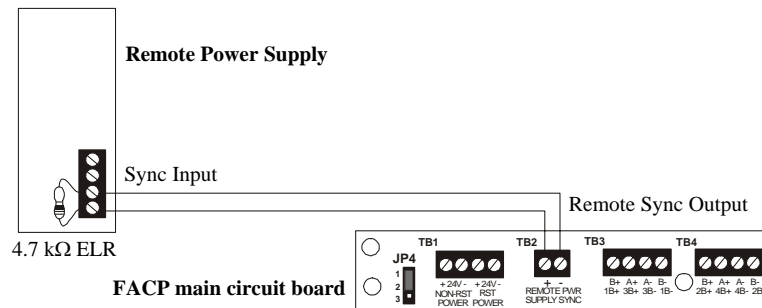
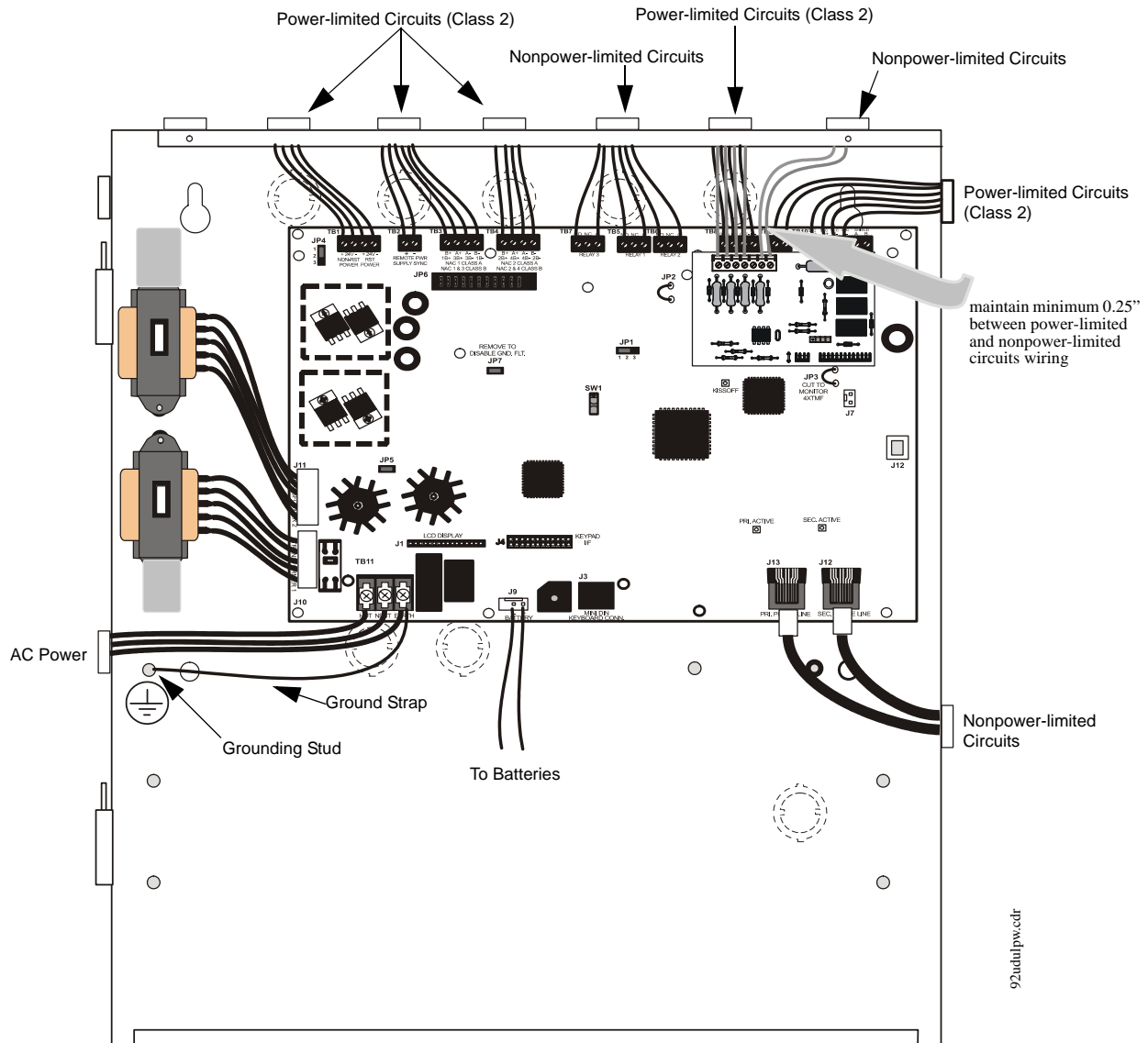

Figure 2.10 Remote Sync Output

2.7 UL Power-limited Wiring Requirements

Power-limited and nonpower-limited circuit wiring must remain separated in the cabinet. All power-limited circuit wiring must remain at least 0.25" (6.35 mm) away from any nonpower-limited circuit wiring and nonpower-limited circuit wiring must enter and exit the cabinet through different knockouts and/or conduits. A typical wiring diagram for the MS-9200UDLS is shown below.

Figure 2.11 Typical UL Power-limited Wiring Requirements



2.8 Digital Communicator

Two independent telephone lines can be connected to the control panel. Telephone line control/command is made possible via double line seizure as well as usage of an RJ31X style interconnection. *Note that it is critical that the panel's digital communicator be located as the first device on the incoming telephone circuit to properly function.*

Important! The DACT must not be used to dial a phone number that is call-forwarded.

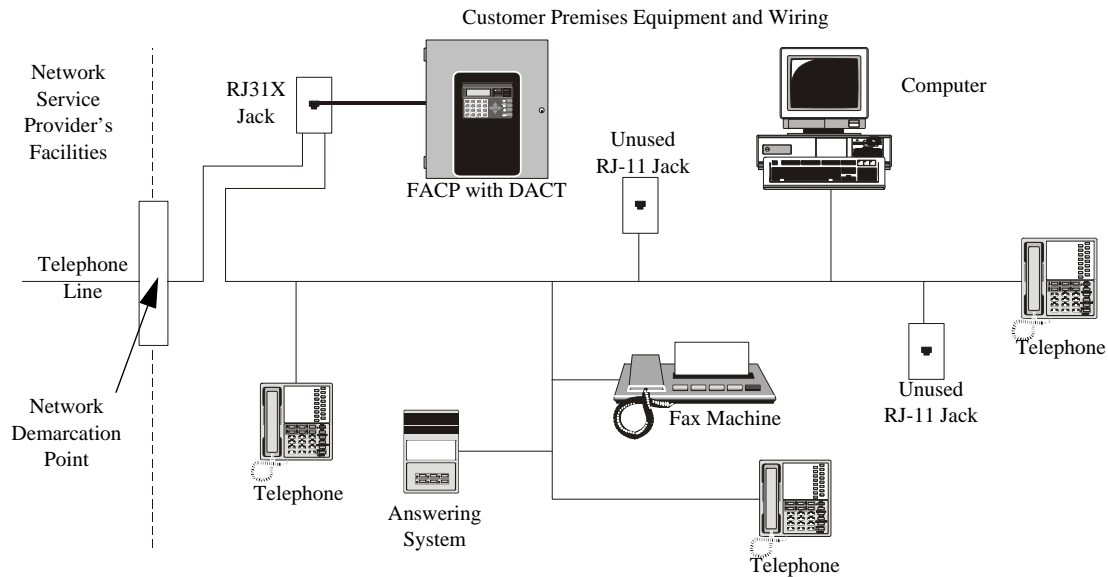

Figure 2.12 DACT Installation

The control panel's digital communicator is built into the main circuit board. Connection and wiring of two phone lines is required as shown below.

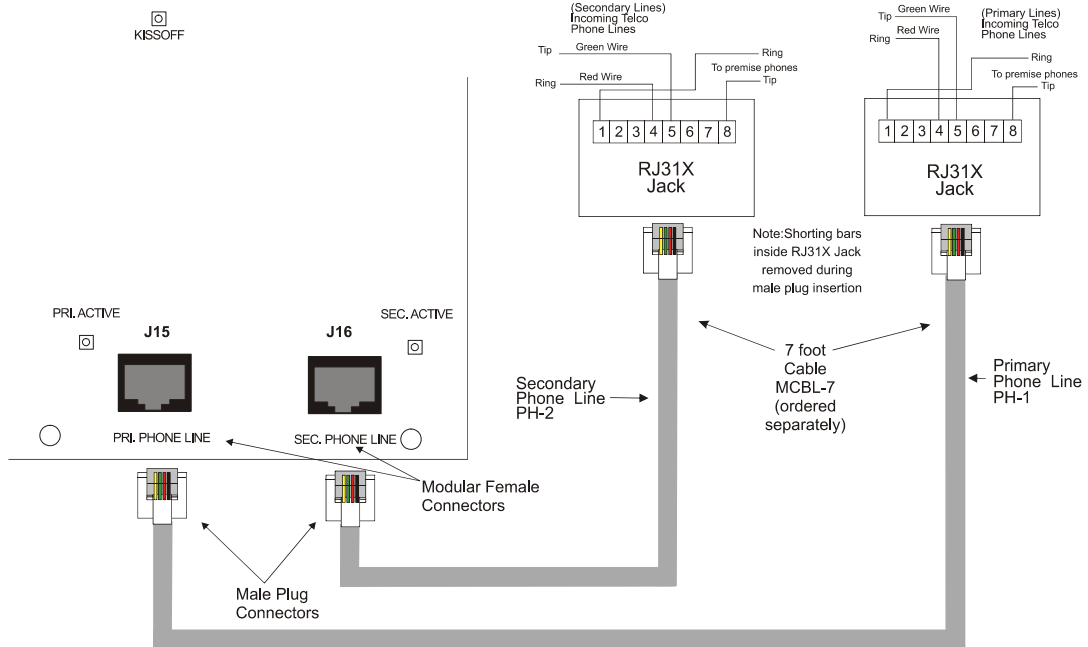

Figure 2.13 Wiring Phone Jacks

2.9 Optional Module Installation

⚡ WARNING! Disconnect all sources of power (AC and DC) before installing or removing any modules or wiring.

MS-9200UDLS Keypad/Display Removal

Removal of the keypad/display is normally not necessary. If, however, it becomes necessary to replace the keypad/display or access jumpers JP5 and JP7 or switch SW1, the Keypad/Display can be removed by inserting a Phillips screwdriver into each of the three holes located in the flexible covering of the Keypad/Display and loosening the three mounting screws. Note that it is not necessary to disconnect the cables between the Keypad/Display and the main circuit board unless the unit itself is being replaced. Carefully lift the Keypad/Display and rest the unit at the bottom of the main circuit board.

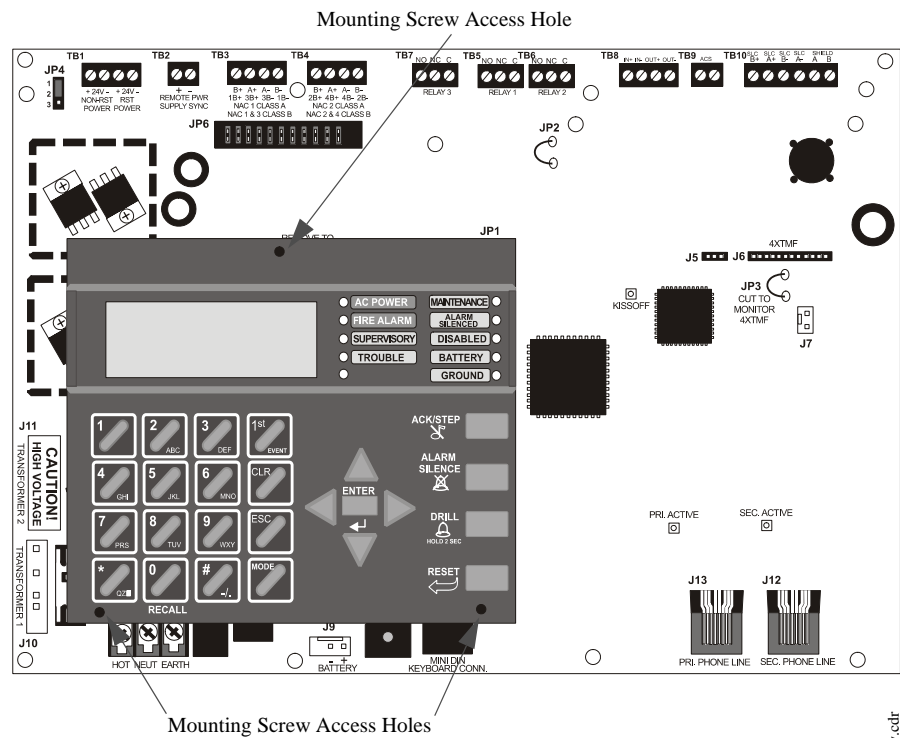

Figure 2.14 Keypad/Display Removal

92udbkty.cdr

2.9.1 4XTMF Transmitter Module Installation

The 4XTMF provides a supervised output for a local energy municipal box transmitter in addition to alarm and trouble reverse polarity. A jumper option allows the reverse polarity circuit to open with a system trouble condition if no alarm condition exists. A disable switch allows disabling of the transmitter output during testing to prevent accidental calling of the monitoring service.

Local Energy Municipal Box Service (NFPA 72 Auxiliary Fire Alarm Systems):

Supervisory Current: 5.0 mA
 Trip Current: 350 mA (subtracted from notification appliance power)
 Coil Voltage: 3.65 VDC
 Maximum Coil Resistance: 14.6 ohms
 Maximum allowable wire resistance between panel and trip coil: 3 ohms
 Municipal Box wiring can leave the building

Remote Station Service (NFPA 72 Remote Station Fire Alarm Systems) - Intended for connection to a polarity reversal circuit or a Remote Station receiving unit having compatible ratings:

Maximum load for each circuit: 10 mA
 Reverse polarity output voltage: 24 VDC
 Remote Alarm and Remote Trouble wiring can leave the building

Before installing the module, place the disconnect switch to the right (disconnect) position to prevent accidental activation of the municipal box. Note that a Disconnect LED will illuminate after the module is installed in the MS-9200UDLS. In addition, the System Trouble LED will turn on to indicate the Disconnect condition.

Note: The 4XTMF Module is not directly suitable for transmitting a reverse polarity supervisory signal. For applications using reverse polarity of a supervisory signal, refer to "FACP with Keltron" on page 204.

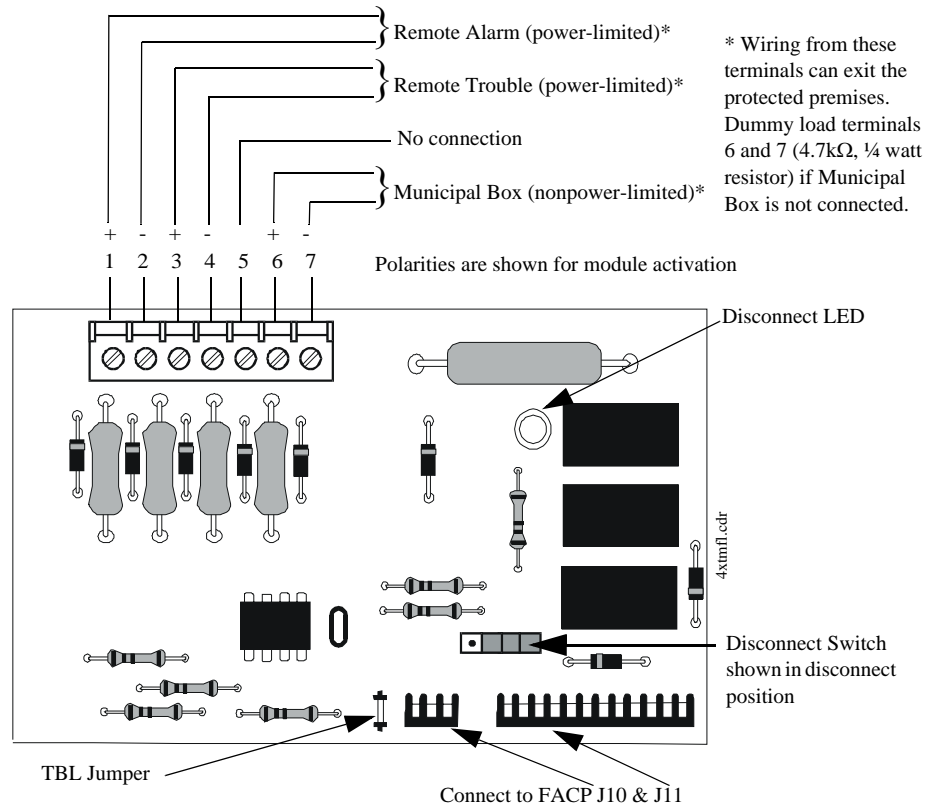

Figure 2.15 4XTMF Transmitter Module

The following steps must be followed when installing the 4XTMF module:



1. Remove all power (Primary and Secondary) from the FACP before installing 4XTMF
2. Cut jumper JP3 on the main circuit board to allow the control panel to supervise the 4XTMF module
3. Carefully plug the connectors on the 4XTMF module into connectors J5 and J6 on the MS-9200UDLS main circuit board, being careful not to bend any pins
4. Secure 4XTMF module to standoffs with supplied screws.
5. Reapply power to the FACP
6. For proper 4XTMF operation, the output relays must be programmed for the factory default settings: Alarm Relay 1, Trouble Relay 2 and Supervisory Relay 3
7. When the installation has been complete, enable the 4XTMF module by sliding the disconnect switch to the left
8. Test system for proper operation

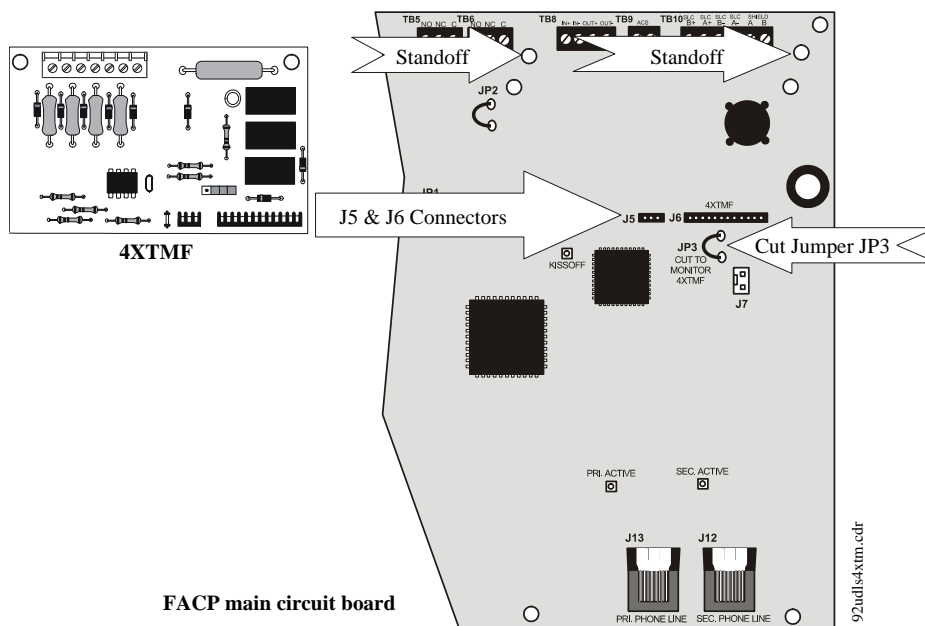

Figure 2.16 4XTMF Connectors to MS-9200UDLS Connectors

NOTE: Jumper JP2 on the FACP main circuit board can be used to configure the FACP supervisory relay for operation with the 4XTMF module. Relay 3 at TB5 must be programmed as a supervisory relay. Cutting JP2 will allow the 4XTMF to generate a trouble if the supervisory contact opens. Leaving JP2 in will prevent generation of a trouble if the supervisory contact opens.

2.9.2 Printer

A serial printer may be connected to TB8 Terminals 1 - 4 on the FACP. The printer can be used to provide a hard-copy printout of real-time events, history file and walktest data. Installation the device requires panel programming to allow the FACP to communicate with the device.

A parallel printer may also be connected to the FACP using the optional ANN-S/PG Serial/Parallel Interface Module. Refer to "ANN-S/PG Serial/Parallel Interface Installation" on page 31 for installation details. Refer to "ANN-BUS Options" on page 118 for programming information.



CAUTION! Do not connect a printer or PC to the MS-9200UDLS FACP if a ground fault (zero impedance to ground) exists on the control panel. Circuit damage may result. Remove all power (Primary and Secondary) before installing or removing any wiring.

Installation

Remote printers and PCs require separate primary power. Also required is the PRT/PK-CABLE which is an interface cable prewired to a DB9F connector. Wire the PRT/PK-CABLE to TB8 Terminals 1 - 4 as illustrated in the following figure. Connect the DB9F connector to the printer or PC serial EIA-232 port. Make certain that the DB25 adapter does not swap the Transmit and Receive lines. Apply power to the FACP and printer or PC. Note that a ground fault (zero impedance to ground) may occur on the FACP, dependent on the printer or PC being used, due to this connection. For this reason, it is important that there be no preexisting ground fault on the panel.

Note that the printer may or may not be supervised as determined by user programming. Refer to "Printer/PC" on page 142.

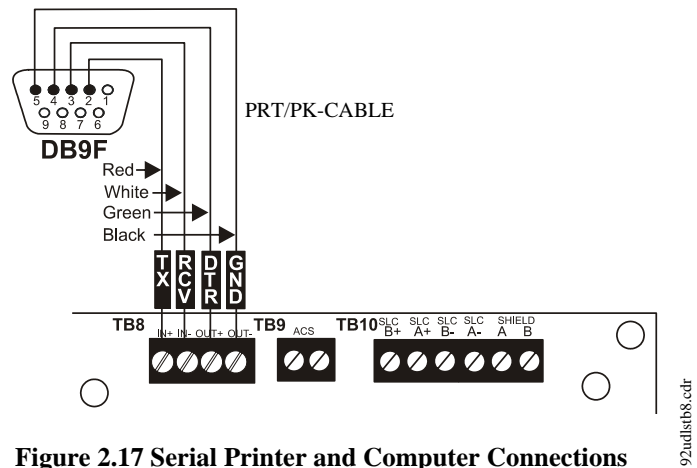

Figure 2.17 Serial Printer and Computer Connections

92udlstb8.cdr

Printer Configuration

Refer to the documentation supplied with the printer for pertinent information about printer setup. Set the printer's options as listed in the following table:

COMMUNICATION SETUP	
BUFFER:	LARGE
DATA BITS:	7
PARITY:	EVEN
STOP BIT:	1 STOP
BAUD RATE:	2400/4800/9600
AUTOMATIC LINE FEED	NO
AUTOMATIC CARRIAGE RETURN	NO

SECTION 3

Programming

NOTICE TO USERS, INSTALLERS, AUTHORITIES HAVING JURISDICTION AND OTHER INVOLVED PARTIES			
This product incorporates field-programmable software. In order for the product to comply with the requirements in the Standard for Control Units and Accessories for Fire Alarm Systems, UL 864, certain programming features or options must be limited to specific values or not used at all as indicated below:			
Program feature or option	Permitted in UL 864? (Y/N)	Possible settings	Settings permitted in UL 864
Trouble Call Limit	N	Refer to "Trouble Call Limit (Dialer Runaway Prevention)" on page 134. Trouble Call Limit = 0 (factory default): unlimited calling to Central Station for any trouble condition Trouble Call Limit = 1 - 99: limits call for each unique trouble to from 1 to 99 within a 24 hour period	Trouble Call Limit = 0 for unlimited Central Station trouble calls
Remote Download	Y	Refer to "Remote Site Upload/Download" on page 184. Remote Download - Proprietary No Remote Download - Proprietary Yes	Remote Download <i>Proprietary Yes</i> for Proprietary system intended to protect only contiguous properties

3.1 Programming Data Entry

Programming can be accomplished using the MS-9200UDLS keypad or by connecting an optional standard computer keyboard. The keyboard can be connected to the PS-2 connector J3 on the control panel main circuit board.

The information presented in this section refers to programming the MS-9200UDLS via the onboard keypad. If an optional computer keyboard is connected to the MS-9200UDLS main circuit board, the following table describes the keyboard keys which correspond to the onboard keypad keys.

Keypad Keys	Computer Keyboard Keys
1st Event	Home
CLR	Delete
ESC	Esc
RECALL	Insert
*	*
#	#
A - Z	A - Z
0 - 9	0 - 9
■ (on QZ key)	Space bar
—	—
/	/
•	•
←	←
→	→
↑	↑
↓	↓
ENTER	Enter
ACK/STEP	F1
SILENCE	F2
DRILL	F3
RESET	F4

3.2 User Programming



The MS-9200UDLS is completely field programmable and requires no special software skills. *While programming the MS-9200UDLS, the fire protection capabilities of the control panel are enabled.*

Site-specific programming may be accomplished in any of the following ways:

- **Autoprogramming Feature** - This is a convenient method for quickly bringing the FACP addressable SLC devices on-line without the necessity of programming each device individually. Refer to "Autoprogram" on page 64 for a detailed description of Autoprogramming
- Manual programming or editing, using the FACP keypad or a PC keyboard
- Remote Programming and Editing Feature - allows creation and editing of site-specific custom programs using a Windows-based computer and modem. For programs requiring a large amount of data entry, this method may be preferred. A PK-CD programming CD-ROM can be ordered for this purpose
- Local Programming and Editing Feature - allows creation and editing of site-specific custom programs using a Windows-based computer and the FACP USB connection. For programs requiring a large amount of data entry, this method may be preferred. A PK-CD programming CD-ROM can be ordered for this purpose

The *System All Normal* screen will be displayed in a programmed system with no active alarms, troubles or supervisories, as illustrated below:

```

SYSTEM ALL NORMAL
10:00A 012106
  
```

Read Status mode can be entered while the panel is in any mode of operation. If an alarm or supervisory event exists at the panel, the event must be cleared before entering Programming mode. To access any of the programming or read status features, the *Enter* or *Mode* key must be pressed, which will cause the LCD to display the following:

```

1=READ STATUS MODE
2=PROGRAMMING MODE
3=REMOTE DOWNLOAD
  
```

Pressing *1*, while this screen is being displayed, will cause the control panel to enter the Read Status Mode which allows the user to view the programmed features and status of the control panel. The Read Status feature is not password protected. Refer to "Read Status" on page 168 for a detailed description of this feature.



See Page

Pressing *2* will select user Programming Mode which may only be accomplished by an authorized person. After pressing *2*, a screen will prompt for a password. After entering the correct password, the user may select from a list of programming options.

Pressing *3* will select Remote Download which allows the user to enable the remote programming option. Refer to "Remote Site Upload/Download" on page 184.

Exit Programming, Read Status

The programmer can exit any mode by repeatedly pressing the keypad *ESC* (Escape) key until the display reads System All Normal. *Note that the data which is entered during Programming mode is not saved until the programmer exits this mode by repeatedly pressing the 'ESC' key. If the Reset key is pressed or power is lost before exiting Programming mode, all data just entered will be lost.*

User Programming Levels

There are two user programming levels:

- User Master Program Level 1 is used for programming panel specific data relating to device types, zoning, messages, control panel functions, etc.
- User Maintenance Program Level 2 is used by a qualified operator to access features such as Disable/Enable, View and Clear History, Walktest and System Time Change.

3.3 Initial Power-up

The following sections describe the initial programming procedures for a new system. The same procedures are used to modify programming in an existing system.

After completing the wiring of addressable devices to the SLC, apply power to the control panel. If the addressable devices have not yet been programmed into the FACP, their LEDs will not flash and the following trouble message will be displayed.

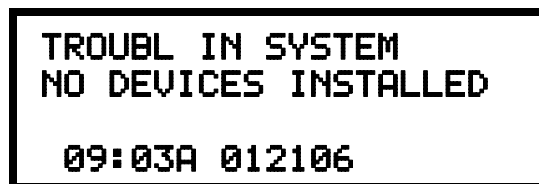

```
TROUBL IN SYSTEM
NO DEVICES INSTALLED

09:03A 012106
```

3.4 Programming Screens Description



See Page

The options available when the *Enter* key is pressed are: Read Status, Programming. The Read Status and Programming options have multiple functions or features which may be chosen. To view all of the choices, it is necessary that the programmer scroll through a number of additional *subscreens*. These selections are displayed on multiple screens to make them more readable for the programmer. Refer to "Master Programming Level" on page 63, for additional information on the various screens.

The title of the main option screen will always be displayed at the top of the subscreens for the programmer's convenience. If additional subscreens exist, an Up or Down arrow will be displayed in the upper right corner of the screen being viewed. The programmer can then press the keypad Up or Down arrow key to view the new subscreen. To select one of the choices in a screen, the programmer presses the keypad numerical key corresponding to the desired choice.

Note that subscreens may also have multiple options which require viewing more than one screen. The same process, as detailed in the previous paragraphs, is followed to view all option choices.

3.5 Programming and Passwords



There are two factory set programming passwords which will access the Programming screens as indicated in the following examples. From either of the screens, access to specific system and device features or programming may be obtained. All user programming entries are stored in nonvolatile memory. The factory set passwords can be changed by the user as described in "Password Change" on page 143. If an invalid password is entered, the blinking cursor will return to the first password character position. To exit Programming or Read Status mode at any time, press the *ESC* (Escape) key repeatedly. Note that Programming mode must be exited using the *ESC* key in order to store the program data entered during this mode. If the *Reset* key is pressed or power is lost before exiting Programming mode, the data just entered will not be saved.

To access user Programming mode, press the *Enter* or *Mode* key. The LCD will display the following:

```

1=READ STATUS MODE
2=PROGRAMMING MODE
3=REMOTE DOWNLOAD

```

To enter the user Programming mode, press 2. The display will read as follows:

```

PROGRAMMING
ENTER PASSWORD
*****

```

Entering the Master level password (default 00000) will cause the following screen to appear:

```

PROGRAMMING
1=AUTOPROGRAM
2=POINT PROGRAM
3=ZONE SETUP

```

If the Maintenance level password (default 11111) is entered, the following screen will appear:

```

PROGRAMMING
1=POINT PROGRAM
2=HISTORY
3=PROGRAM CHECK

```

Note that in the two preceding screens, an arrow appears to inform the programmer that additional options can be viewed by pressing the keypad *down* arrow key.

3.6 Master Programming Level

When the Master Program Level password is entered, the control panel will enter user Programming mode. In this mode, the piezo sounder remains off, the trouble relay is activated and the system Trouble LED flashes until Programming mode is exited. The following display will appear:



Programming Screen #1

The down arrow which appears in the display indicates that additional programming choices can be viewed by pressing the down arrow key on the keypad. If a down and up arrow appear in the display, pressing the 'down' arrow key will display the subsequent Programming Screens as illustrated below while pressing the 'up' arrow key will display the previous screen.



Programming Screen #2



Programming Screen #3

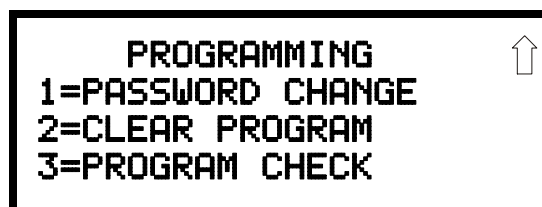

Programming Screen #4

```

PROGRAMMING
1=AUTOPROGRAM
2=POINT PROGRAM
3=ZONE SETUP
    
```

Programming Screen #1

3.6.1 Autoprogram

Pressing *I* while viewing Programming Screen #1, will select the Autoprogram option, which prompts the control panel to poll all devices installed on the SLC loop. The primary purpose of autoprogramming is to allow the installer a fast and easy way to bring the system on-line as quickly as possible. The first time the system is powered-up, it should be autoprogrammed.

If the system is already programmed and Autoprogram is initiated, the system will only add default values for newly installed devices.

When Autoprogram is selected, the control panel will begin autoprogramming the system by communicating with each addressable device installed on the SLC loop. While autoprogramming, the panel will display the following:

```

AUTOPROGRAM
AUTOPROGRAMMING!
PLEASE WAIT
    
```

Autoprogram Progress Screen

When Autoprogramming is completed, the control panel will display the type and quantity of each device installed on the SLC loop similar to the following display:

```

# OF DET LOOP1 055
# OF MON LOOP1 035
# OF CON LOOP1 030
    
```

Autoprogram Result Screen #1

In the preceding example, the display indicates that the SLC Loop has 55 addressable detectors, 35 monitor modules and 30 control modules installed.

Pressing the *ESC* key will return the display to Programming Screen #1.

3.6.2 Point Program

```

PROGRAMMING
1=AUTOPROGRAM
2=POINT PROGRAM
3=ZONE SETUP

```

Programming Screen #1

The Point Program option allows the programmer to add a new addressable device to an SLC loop, delete an existing device from a loop or change the programming for an existing device. Pressing 2, while viewing Programming Screen #1, will select the Point Program option and display the following screen:

```

POINT PROGRAM
SELECT TYPE
1=DETECTOR
2=MODULE

```

Point Program Screen

3.6.2.1 Detector Programming

Pressing 1, while viewing the Point Program Screen, will allow the programmer to add, delete or change the programming of an addressable detector. The following screen will be displayed by the control panel:

```

DETECTOR
1=ADD
2=DELETE
3=EDIT

```

Detector Screen

3.6.2.1.1 Add Detector

Pressing 1 while viewing the Detector Screen will display the following screen which allows the programmer to add a new detector address to programming:

```

ADD DETECTOR
ENTER DETECTOR#
***

```

Add Detector Screen

A flashing cursor will appear in the position of the first asterisk to the left. The programmer keys in the three digit detector address, such as 005.

When the last digit is keyed-in, the following screen will be displayed:

```

DETECTOR TYPE
1=SMOKE (PHOTO)
2=USER-DEFINED-1
3=SMOKE (ION)

```

Press the down arrow key to view additional choices. Press the number corresponding to the desired selection to program that type to the newly added detector.

When the type has been selected, the following screen will be displayed:



The programmer can continue adding detectors by pressing the *ESC* key which will return the display to the Add Detector Screen.

3.6.2.1.2 Delete Detector

Pressing 2 in the Detector Screen will display the Delete Detector Screen which allows the programmer to delete a specific detector:

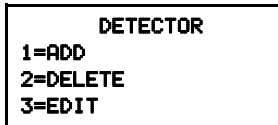

Detector Screen



Delete Detector Screen

A flashing cursor will appear in the position of the first asterisk to the left. The programmer keys in the three digit detector address, such as 005. When the last digit is keyed-in, the following screen will be displayed:



The programmer can continue deleting detectors by pressing the *ESC* key which will return the display to the Delete Detector Screen.

3.6.2.1.3 Edit Detector

The programmer can change a detectors existing or factory default programming by pressing 3 in the Detector Screen. The following screen will be displayed:



Edit Detector Screen

A flashing cursor will appear in the position of the first asterisk to the left. The programmer keys in the three digit detector address, such as 017.

When the last digit is keyed-in, if the selected address has not been added to programming, a screen showing information about a device that is installed with a lower address, closest to the selected address, will be displayed.

If no detectors have been installed on the loop, the following will be displayed:

```

NO DETECTOR
INSTALLED

```

Edit Detector Screen #1

If the selected address has been added to programming, device summary screens will be displayed. These screens allow the programmer to view all device settings at a single glance. Pressing the left or right arrow keys will allow the programmer to rapidly view the devices at the previous or next address (if installed).

If a detector (such as a photoelectric detector) with the selected address is not physically installed on the SLC or has a communication fault but the address is programmed in the system, the following screen will be displayed:

```

TROUBL SMOKE (PHOTO)
<ADJ> <NOUN>
                ZNNN
                *   1D017

```

Edit Detector Screen #1

If the selected address has been added to programming and a detector (such as a photoelectric detector) with the selected address is physically installed on the SLC and is communicating with the control panel, the following will be displayed:

```

NORMAL SMOKE (PHOTO)
<ADJ> <NOUN>
                ZNNN
                V   1D017

```

Edit Detector Screen #1

To change the programming for the displayed detector, press the keyboard 'down' arrow key to view the Edit Detector screens.

In the preceding example:

- ✓ Normal - indicates that the detector with the selected address is physically installed on the SLC and communicating with the control panel (enabled)
- ✓ <ADJ><NOUN> - represents the adjective and noun, which have been programmed, describing the location of the displayed device
- ✓ ZNNN - represents the first of five possible software zones that the detector is assigned to (NNN = the three digit zone number from 000 - 099)
- ✓ V or * - indicates whether or not alarm verification is enabled (V = alarm verification enabled and * = alarm verification disabled)
- ✓ 1D017 - represents the Loop, Device type and Device address (1 = SLC Loop, D=Detector and 017 = Detector Address 017)

The following examples show the editing of a photoelectric smoke detector with address 017, located on the SLC loop:

```

EDIT DETECTOR 1D017
1=ENABLED      YES
2=TYPE  SMOKE(PHOTO)
3=VERIFICATION OFF
    
```

Edit Detector Screen #2

```

EDIT DETECTOR 1D017
1=WALKTEST    NO
2=PAS         NO
3=PRE-SIGNAL  NO
    
```

Edit Detector Screen #3

```

EDIT DETECTOR 1D017
1=ZONE ASSIGNMENT
  00 ** ** ** **
    
```

Edit Detector Screen #4

```

EDIT DETECTOR 1D017
1=NOUN/ADJECTIVE
2=DESCRIPTION
*****
    
```

Edit Detector Screen #5

```

EDIT DETECTOR
1=ENABLED
2=TYPE
3=VERIFICATION
    
```

Edit Detector Screen #2

Enable/Disable Detector

To Enable or Disable the detector, press the *I* key while viewing the Edit Detector Screen #2. Each press of the key will toggle the screen between *Enabled Yes* and *Enabled No*. If *Enabled No* is selected, the detector will not be polled by the control panel, preventing the detector from reporting alarms and troubles to the panel. The control panel will display the device type and address which has been disabled and will turn on the Trouble LED and Disable LED.

Type

EDIT DETECTOR
1=ENABLED
2=TYPE
3=VERIFICATION

Edit Detector Screen #2

To select the type of detector being programmed, press the 2 key while viewing the Edit Detector Screen #2. This will cause the control panel to display the following Detector Type Screens:

DETECTOR TYPE 
1=SMOKE (PHOTO)
2=USER-DEFINED-1
3=SMOKE (ION)

Detector Type Screen #1

Pressing the down arrow key will display additional detector types as indicated in the following table.

Detector Type	Action When Activated
Smoke Photo	Fire Alarm
User-Defined-1	same as previous (Smoke Photo)
Smoke Ion	Fire Alarm
User-Defined-2	same as previous (Smoke Ion)
Heat Detect	Fire Alarm
User-Defined-3	same as previous (Heat Detect)
Smoke DuctP	Fire Alarm
User-Defined-4	same as previous (Smoke DuctP)
Photo w/Heat	Fire Alarm
User-Defined-5	same as previous (Photo w/Heat)
Duct-Superv	Supervisory, latching
User-Defined-6	same as previous (Superv DuctP)
Photo-SupervAR	Supervisory, nonlatching (works only in LiteSpeed)
User-Defined-7	same as previous (Photo-SupervAR)
ADAPT	Fire Alarm
User-Defined-8	same as previous (ADAPT)
Beam	Fire Alarm
User-Defined-9	same as previous (Beam)

While viewing either Detector Type screen, select the type of detector being programmed by pressing the corresponding keyboard number key. The display will return to Edit Detector Screen #2 and indicate the selection next to the Type option.

Note: If a detector is selected to be a SUPERV DUCTP type, it will function like a supervisory point not a fire alarm point. The supervisory LED and supervisory relay will activate, not the fire alarm LED or alarm relay, if the detector senses smoke.

Verification

Alarm verification is used to confirm that a smoke detector activation is a true alarm condition and not a false alarm. This feature is selected by pressing 3 while viewing the Edit Detector Screen #2 so that the display reads *Verification On*. Each time the 3 key is pressed, the display will toggle between *Verification On* and *Verification Off*. For a detailed description, refer to "Alarm Verification (None or One Minute)" on page 166.



Walktest

The Walktest feature allows one person to test the system devices without the necessity of manually resetting the control panel after each device activation. To enable a device for the Walktest feature, press 1 while viewing the Edit Detector Screen #3 until the display reads *Walktest Yes*. Each press of the 1 key will cause the display to toggle between *Walktest Yes* and *Walktest No*. Refer to "Walktest" on page 167.

EDIT DETECTOR
1=WALKTEST
2=PAS
3=PRE-SIGNAL

Edit Detector Screen #3

PAS

The PAS (Positive Alarm Sequence) option will program the detector to delay panel activation (including alarm relay and communicator) for a period of 15 seconds plus a programmable time of up to 3 minutes. Zone 97, however, will activate immediately and may be used to connect a signaling device to indicate PAS activation (*do not use a Notification Appliance Circuit for this purpose*). To enable the PAS feature, press 2 while viewing the Edit Detector Screen #3 until the display reads *PAS Yes*. Each press of the 2 key will cause the display to toggle between *PAS Yes* and *PAS No*. Refer to "Positive Alarm Sequence" on page 165.



For example, if a detector with address 005 is to be configured for PAS operation:

- ✓ Select *PAS Yes* when editing the detector set to address 005
- ✓ Program the desired zone or zones to be activated by this detector, in this example Z001
- ✓ Program an output, such as a control module that is to be activated by detector 005 by assigning the same zone to it; in this example Z001
- ✓ Program an output, such as a control module, for PAS activation by assigning zone Z97 to it. This control module may be connected to a signaling device used to indicate a PAS condition (*do not use a Notification Appliance Circuit for this purpose*)
- ✓ Enable zones Z001 and Special Purpose Zone PAS 97 and set the PAS delay timer to some value

With the preceding program settings, when the detector with address 005 is activated, zone Z97 will cause its associated control module to activate immediately, sounding the connected PAS signaling device. Following the PAS delay time, zone Z001 will cause its associated control module to activate and the control panel will initiate an alarm condition.

Note that a detector can be enabled for either PAS or Pre-signal but not both

Pre-signal



Edit Detector Screen #3



The Pre-signal option programs the detector to delay panel activation for a preprogrammed time delay of up to three minutes while allowing for visual verification by a person. Note that the alarm relay and communicator will respond to the initial alarm immediately. In addition, Zone 98 will activate. This zone can be programmed to a control module which may be used to activate a sounder or indicator which the installer designates as a Presignal indication (*do not use a Notification Appliance Circuit for this purpose*). To enable the Pre-signal feature, press 3 while viewing Edit Detector Screen #3 until the display reads *Pre-signal Yes*. Each press of the 3 key will cause the display to toggle between *Pre-signal Yes* and *Pre-signal No*. Refer to "Presignal" on page 164.

For example, if a detector with address 005 is to be configured for Pre-Signal operation:

- ✓ Select *Pre-signal Yes* when editing the detector set to address 005
- ✓ Program the desired zone or zones to be activated by this detector, in this example Z001
- ✓ Program an output, such as a control module that is to be activated by detector 005 by assigning the same zone to it; in this example Z001
- ✓ Program an output, such as a control module, for Pre-signal activation by assigning zone Z98 to it. This control module may be connected to a signaling device used to indicate a Pre-signal condition (*do not use a Notification Appliance Circuit for this purpose*)

- ✓ Enable zones Z001 and Special Purpose Zone Pre-signal 98 and set the Pre-signal delay timer to some value

With the preceding program settings, when the detector with address 005 is activated, zone Z98 will cause its associated control module to activate immediately, sounding the connected signaling device to indicate the Pre-signal condition. Following the Pre-signal delay time, zone Z001 will cause its associated control module to activate and the control panel will initiate an alarm condition.

Note that a detector can be enabled for either PAS or Pre-signal but not both

Zone Assignment

A maximum of five zones can be programmed to each addressable detector. Pressing *1* while viewing Edit Detector Screen #4 displays the following screen:

```

EDIT DETECTOR
1=ZONE ASSIGNMENT
 00 ** ** ** **
    
```

Edit Detector Screen #4

```

ZONE ASSIGNMENT
Z00 Z** Z** Z** Z**
    
```

Zone Assignment Screen

Note that Z** represents the Zone Number(s) corresponding to this device. The factory default for an unprogrammed device is Z00 for general alarm zone. A flashing cursor will appear on the first 0 to the left. Enter the two digit number corresponding to the zone that is to be assigned to this device. The cursor moves to the next Z** designation. Continue entering zone assignments or the remaining zones can be left blank or programmed as general alarm zone Z00. When all desired changes have been made, press the Enter key to store the zone assignments. The display will return to the Edit Detector Screen #4. Note that the left and right arrow keys can be used to navigate through the zones and the CLEAR key can be used to quickly clear a zone.



Noun/Adjective

The Noun/Adjective selection allows the programmer to enter specific descriptors about the detector currently being programmed. Pressing *1* while viewing Edit Detector Screen #5 will cause the following screen to be displayed:

```

EDIT DETECTOR
1=NOUN/ADJECTIVE
2=DESCRIPTION
*****
    
```

Edit Detector Screen #5

```

1=STANDARD ADJECTIVE
2=STANDARD NOUN
3=CUSTOM ADJECTIVE
4=CUSTOM NOUN
    
```

Noun/Adjective Screen

1=STANDARD ADJECTIVE
2=STANDARD NOUN
3=CUSTOM ADJECTIVE
4=CUSTOM NOUN

Noun/Adjective Screen

Pressing 1 while viewing the Noun/Adjective Screen will cause the following screen(s) to be displayed. Note that the keyboard *down* arrow key must be pressed to see all the Adjective screens. Press the number corresponding to the adjective that is to be used as a descriptor for the location of the detector currently being programmed. When an adjective has been selected, it will appear at the top of the display as indicated by the asterisks.

```
*****  
1=NORTH  
2=SOUTH  
3=EAST
```

Adjective Screen #1

```
*****  
1=3RD  
2=4TH  
3=5TH
```

Adjective Screen #5

```
*****  
1=WEST  
2=FRONT  
3=CENTER
```

Adjective Screen #2

```
*****  
1=FLOOR1  
2=FLOOR2  
3=FLOOR3
```

Adjective Screen #6

```
*****  
1=REAR  
2=UPPER  
3=LOWER
```

Adjective Screen #3

```
*****  
1=FLOOR4  
2=FLOOR5  
3=ROOM
```

Adjective Screen #7

```
*****  
1=MAIN  
2=FIRST  
3=2ND
```

Adjective Screen #4

1=STANDARD ADJECTIVE
 2=STANDARD NOUN
 3=CUSTOM ADJECTIVE
 4=CUSTOM NOUN

Noun/Adjective Screen

Pressing 2 while viewing the Noun/Adjective Screen will cause the following screen(s) to be displayed. Note that the keyboard *down* arrow key must be pressed to see all the Noun screens. Press the number corresponding to the noun that is to be used as a descriptor for the location of the detector currently being programmed. When a noun has been selected, it will appear at the top of the display as indicated by the asterisks.

```
*****
1=BASEMENT
2=BOILER RM
3=CLASSROOM
```

Noun Screen #1

```
*****
1=KITCHEN
2=LOBBY
3=OFFICE
```

Noun Screen #5

```
*****
1=CLOSET
2=CORRIDOR
3=ELECTRIC RM
```

Noun Screen #2

```
*****
1=PATIENT
2=RESTROOM
3=ROOM
```

Noun Screen #6

```
*****
1=ELEVATOR
2=ENTRANCE
3=FLOOR
```

Noun Screen #3

```
*****
1=STAIRWAY
2=STOREROOM
3=WING
```

Noun Screen #7

```
*****
1=GARAGE
2>HALLWAY
3>HVAC RM
```

Noun Screen #4

```
*****
1=ZONE
```

Noun Screen #8

```

1=STANDARD ADJECTIVE
2=STANDARD NOUN
3=CUSTOM ADJECTIVE
4=CUSTOM NOUN
    
```

Noun/Adjective Screen

```

EDIT DETECTOR
1=NOUN/ADJECTIVE
2=DESCRIPTION
    
```

Edit Detector Screen #5

Pressing 3 or 4 while viewing the Noun/Adjective Screen will display screens similar to the previous Adjective and Noun Screens. The new screens will list custom Adjectives and Nouns which have been programmed into the control panel using the PS-Tools utility. These descriptors are selected as described in the previous sections.

Description

The Description selection allows the programmer to enter additional information about the detector currently being programmed. This information will be displayed as part of the device label on the display. Pressing 2 while viewing Edit Detector Screen #5 will cause the following screen to be displayed:

```

DESCRIPTION      1D002
NOUN/ADJECTIVE

*****
    
```

Adjective/Noun Screen

A flashing cursor will appear at the first asterisk to the left. The programmer can enter additional descriptive information about the device being programmed. This information will appear on the display along with the standard device label information.

A maximum of 20 characters (including spaces) can be entered. To enter alphanumeric characters from the keypad, repeatedly press the appropriate key until the desired character is displayed in the first position. For example, to enter the letter *B*, press the 2 (ABC) key three times to toggle through the characters 2, *A* and *B*. Press the right arrow key to move the cursor one position to the right and repeat the process to enter the next character. To enter a space, press the * (*QZ*) key four times until a blank appears in the desired position. When all characters have been entered, press the Enter key to store the information. The display will return to the Edit Detector Screen #5, displaying the new information at the bottom of the screen.

Recall/Increment Function

In addition, the user may use the Recall/Increment function at any time when the cursor is on the first letter of the Description, Adjective or Noun field as follows:

- If the zero key is pressed, a 0 is placed in the first letter position
- If the zero key is then pressed a second time with no intervening key actions, the entire field is replaced with the field entered *for the previous device programmed*, and the cursor moves to the last character of the field (Recall function). The Recalled Adjective or Noun field may now be changed letter-by-letter
- If the zero key is pressed again with no other intervening key actions and the last character in the field is a number 0-9, the number is incremented by one. If the last character is a letter, it changes to a 0. If the last character is 9 it goes to 0
- The above increment function may be repeated with each press of the zero key

As an example, the user could quickly enter 'FLR_3_ROOM_305' as follows:

1. The cursor is on the first letter of the Adjective field. Press the zero key twice to display *FLR_3*
2. With the cursor on the first letter of the Noun field, press the zero key twice to recall the display *ROOM_304*. The cursor automatically jumps from the first to the last letter of the Noun field
3. With the cursor on the last letter of the Noun field, press the zero key again to increment the room number to *305*
4. Press the right arrow key to advance the zone field
5. Select a zone number from 00 to 99. Z00 (default zone) is the general alarm zone. Z01 through Z99 may be selected to link software zones

3.6.2.2 Module Programming

Pressing 2, while viewing Point Program Screen #2, will allow the programmer to add, delete or change the programming of an addressable module. The following screen will be displayed by the control panel:

```
POINT PROGRAM
SELECT TYPE
1=DETECTOR
2=MODULE
```

Point Program Screen #2

```
MODULES
1=ADD
2=DELETE
3=EDIT
```

Modules Screen

3.6.2.2.1 Add Module

Pressing 1 while viewing the Modules Screen will display the following screen which allows the programmer to add a new module address to programming:

```
ADD MODULE
ENTER MODULE#
***
```

Add Module Screen #1

A flashing cursor will appear in the position of the first asterisk to the left. The programmer keys in the three digit module address, such as *005*.

When the last digit is keyed-in, the following screen will be displayed:

```
ADD MODULE
1=CONTROL
2=MONITOR
```

Add Module Screen #2

Pressing 1 for Control Module or 2 for Monitor Module will cause the following

screen to be displayed:

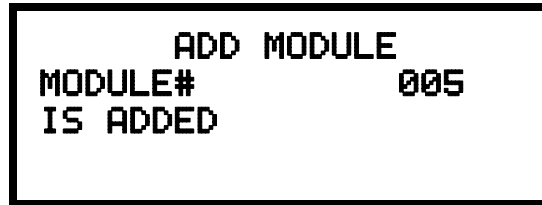

Add Module Screen #3

The programmer can continue adding modules by pressing the *ESC* or left arrow key which will return the display to the Add Module Screen #1.

3.6.2.2.2 Delete Module

Pressing 2 in the Modules Screen will display the Delete Module Screen which allows the programmer to delete a specific module:



Modules Screen

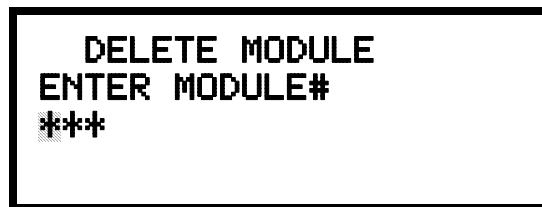

Delete Module Screen

A flashing cursor will appear in the position of the first asterisk to the left. Using the panel keypad, key in the module address such as 005. When the last digit is keyed in, the following confirmation that the module has been deleted will be displayed:



3.6.2.2.3 Edit Module Screen for Monitor Module

The programmer can change a modules existing or factory default programming by pressing 3 in the Modules Screen. The following screen will be displayed:

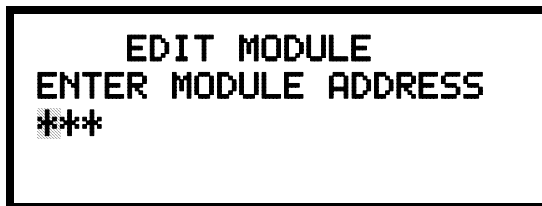

Edit Module Screen

A flashing cursor will appear in the position of the first asterisk to the left. The programmer keys in the three digit module address, such as 012. When the last digit is keyed-in, if the selected address has not been added to programming, a screen showing information about a device that is installed with a lower address, closest to the selected address, will be displayed. If no modules are installed on the loop, the following screen will be displayed:

```

NO MODULE
INSTALLED

```

Edit Module Screen

If the selected address has been added to programming but a module (such as a monitor module) with the selected address is not physically installed on the SLC or has a communication fault, the following screen will be displayed:

```

TROUBL MONITOR
<ADJ> <NOUN>
      ZNNN
      *  1M012

```

If the selected address has been added to programming and a module (such as a monitor module) with the selected address is physically installed on the SLC and is communicating with the control panel, the following screen will be displayed:

```

NORMAL MONITOR
<ADJ> <NOUN>
      ZNNN
      W  1M012

```

To change the programming for the displayed module, press the keyboard down arrow key to view the following Edit Monitor screens. In the preceding example:

- ✓ Normal - indicates that the module with the selected address is physically installed on the SLC and communicating with the control panel (enabled)
- ✓ <ADJ><NOUN> - represents the adjective and noun, which have been programmed, describing the location of the displayed device
- ✓ ZNNN - represents the first of five possible software zones that the module is assigned to (NNN = the two digit zone number from 000 - 099)
- ✓ 1M012 - represents the Loop, Device type and Device address (1 = SLC Loop 1, M=Module and 012 = Module Address 012)
- ✓ W or * - indicates whether or not the device is programmed for Walktest (W = programmed for walktest, * = not programmed for walktest).



If the selected address corresponds to a control module, a screen displaying information about the control module with the selected address will be displayed as shown in "Edit Module Screen for Control Modules" on page 85.

If the selected address corresponds to a monitor module, a screen displaying information about the module with the selected address will be displayed as illustrated in the following:

```

NORMAL MONITOR      ↓
      <ADJ> <NOUN>
                ZNNN
                1M012
    
```

```

EDIT MONITOR  1M012  ↑
1=ENABLED      YES
2=TYPE  MONITOR
    
```

Edit Monitor Screen #2

```

EDIT MONITOR  1M012  ↑↓
1=PRE-SIGNAL   NO
    
```

Edit Monitor Screen #3

```

EDIT MONITOR  1M012  ↑↓
1=WALKTEST     YES
2=ZONE ASSIGNMENT
   00 ** ** ** **
    
```

Edit Monitor Screen #4

```

EDIT MONITOR  1M012  ↑
1=ADJECTIVE/NOUN
2=DESCRIPTION
*****
    
```

Edit Monitor Screen #5

Enable/Disable Module

To Enable or Disable the monitor module, press the *1* key while viewing the Edit Module Screen #2. Each press of the key will toggle the screen between *Enabled Yes* and *Enabled No*. If *Enabled No* is selected, the module will not be polled by the control panel, preventing the module from reporting alarms and troubles to the panel. The control panel will indicate a system trouble condition and the Disable LED will turn on if any devices are disabled.

```

EDIT MONITOR
1=ENABLED
2=TYPE MONITOR

```

Edit Monitor Screen #2

Type Monitor

Using the PK-CD Upload/Download utility program, unique user-defined monitor types can be created and loaded into the FACP for later use. The FACP response to the activation of a user-defined type is the same as most previous standard types in the list, thus allowing a variety of user-defined types and responses. To select the type of monitor module being programmed, press the *2* key while viewing the Edit Monitor Screen #2. This will cause the control panel to display the following Monitor Type Screens:

```

MONITOR TYPE
1=PULL-STATION
2=USER-DEFINED-1
3=WATERFLOW

```

Monitor Type Screen #1

Pressing the down arrow key will display additional Monitor Type screens. While viewing one of the Monitor Type screens, select the type of monitor module being programmed by pressing the corresponding keypad number key. The display will return to the Edit Monitor Screen #2 which will show the new type selection.

Table 3.1 on page 80 lists the Monitor Types and their respective functions.

Monitor module type selection will affect the function of the point as follows:

Table 3.1 Monitor Types

Monitor Type	Action When Activated
Pull-Station	Fire Alarm
User-Defined-1	same as previous (Pull-Station)
Waterflow	Fire Alarm Delayed
User-Defined-2	same as previous (Waterflow)
Monitor	Fire Alarm
User-Defined-3	same as previous (Monitor)
Future	not used
Future	not used
Smoke-Conventional	Fire Alarm
User-Defined-5	same as previous (Smoke-Conventional)
Heat-Conventional	Fire Alarm
User-Defined-6	same as previous (Heat-Detector)
Medic-Alert ³	Supervisory, latching
User-Defined-7	same as previous (Medic-Alert)
Hazard-Alert ³	Supervisory, latching
User-Defined-8	same as previous (Hazard-Alert)
Tornado-Alert ³	Supervisory, latching
User-Defined-9	same as previous (Tornado-Alert)
Phone	Active Phone (LCD display only)
User-Defined-10	same as previous (Phone)
Tamper	Supervisory, nonlatching (tracking)
User-Defined-11	same as previous (Tamper)
Supervisory	Supervisory, latching
User-Defined-12	same as previous (Supervisory)
Supervisory-AR ¹	Supervisory, nonlatching (tracking)
User-Defined-13	same as previous (Supervisory-AR)
HVAC OVRRIDE ²	Switch Supervisory, nonlatching (tracking)
Power-Monitor	Power Fault
User-Defined-14	same as previous (Power Monitor)
Trouble-Monitor	Trouble
User-Defined-15	same as previous (Trouble Monitor)
Process-Monitor ³	Piezo
User-Defined 16	same as previous (Process-Monitor)
Process-Monitor-AR ^{1, 3}	Piezo, nonlatching (tracking)
User-Defined-17	same as previous (Process-Monitor-AR)
Future	not used
Future	not used
Ack-Switch	Acts like panel Acknowledge Key
Sil-Switch	Acts like panel Silence Key
Reset-Switch	Acts like panel Reset Key
Drill-Switch	Acts like panel Drill Key
PAS-Bypass	PAS Disable
HVAC RESTART ²	Switch (see note 2)
Drill-Switch-AR ¹	Acts like panel Drill Key, nonlatching (tracking)

Note:

1. For entries ending in AR, AR refers to AutoResettable
2. For HVAC RESTART and HVAC OVRRIDE descriptions, refer to "Monitor Module Operation" on page 208
3. Combination systems employing these non-fire monitor types require the SLC loop to be programmed by the installer for Style 4 operation **and** isolator modules must be employed on each non-fire branch of the SLC as per Figure 13 in the SLC Wiring Manual (document number 51309). Fire and non-fire devices must not be used on the same SLC branch.

```

EDIT MONITOR
1=PRE-SIGNAL
    
```

Edit Monitor Screen #3



```

EDIT MONITOR
1=WALKTEST
2=ZONE ASSIGNMENT
 00 ** ** ** **
    
```

Edit Monitor Screen #4

Pre-signal

To enable the Pre-signal feature, press *1* while viewing Edit Monitor Screen #3 until the display reads *Pre-signal Yes*. Each press of the *1* key will cause the display to toggle between *Pre-signal Yes* and *Pre-signal No*. Refer to "Presignal" on page 164 for additional information.

Walktest

The Walktest feature allows one person to test the system devices without the necessity of manually resetting the control panel after each device activation. To enable devices, which are connected to a monitor module, for the Walktest feature, press *1* while viewing the Edit Monitor Screen #4 until the display reads *Walktest Yes*. Each press of the *1* key will cause the display to toggle between *Walktest Yes* and *Walktest No*. Refer to "Walktest" on page 167 for additional information.

Zone Assignment

A maximum of five zones can be programmed to each addressable monitor module. Pressing *2* while viewing Edit Monitor Screen #4 displays the following screen:

```

MON ZONE ASSIGN
Z00 Z** Z** Z** Z**
    
```

Zone Assignment Screen

Note that *Z*** represents the Zone Number(s) corresponding to this device. The factory default for an unprogrammed device is *Z00* for general alarm zone. A flashing cursor will appear on the first *0* to the left. Enter the two digit number corresponding to the zone that is to be assigned to this device. The cursor moves to the next *Z*** designation. Continue entering zone assignments or the remaining zones can be left blank or programmed as general alarm zones *Z00*. When all desired changes have been made, press the Enter key to store the zone assignments. The display will return to the Edit Monitor Screen #4.

```

EDIT MONITOR
1=NOUN/ADJECTIVE
2=DESCRIPTION
*****
    
```

Edit Monitor Screen #5

Noun/Adjective

The Noun/Adjective selection allows the programmer to enter specific descriptors about the monitor module currently being programmed. Pressing *1* while viewing Edit Monitor Screen #5 will cause the following screen to be displayed:

```

1=STANDARD ADJECTIVE
2=STANDARD NOUN
3=CUSTOM ADJECTIVE
4=CUSTOM NOUN
    
```

Noun/Adjective Screen

1=STANDARD ADJECTIVE
2=STANDARD NOUN
3=CUSTOM ADJECTIVE
4=CUSTOM NOUN

Noun/Adjective Screen

Pressing 1 while viewing the Noun/Adjective Screen will cause the following screen(s) to be displayed. Note that the keyboard *down* arrow key must be pressed to see all the Adjective screens. Press the number corresponding to the adjective that is to be used as a descriptor for the location of the monitor module currently being programmed.

```
*****  
1=NORTH  
2=SOUTH  
3=EAST
```

Adjective Screen #1

```
*****  
1=3RD  
2=4TH  
3=5TH
```

Adjective Screen #5

```
*****  
1=WEST  
2=FRONT  
3=CENTER
```

Adjective Screen #2

```
*****  
1=FLOOR 1  
2=FLOOR 2  
3=FLOOR 3
```

Adjective Screen #6

```
*****  
1=REAR  
2=UPPER  
3=LOWER
```

Adjective Screen #3

```
*****  
1=FLOOR 4  
2=FLOOR 5  
3=ROOM
```

Adjective Screen #7

```
*****  
1=MAIN  
2=FIRST  
3=2ND
```

Adjective Screen #4

1=STANDARD ADJECTIVE
 2=STANDARD NOUN
 3=CUSTOM ADJECTIVE
 4=CUSTOM NOUN

Noun/Adjective Screen

Pressing 2 while viewing the Noun/Adjective Screen will cause the following screen(s) to be displayed. Note that the keyboard *down* arrow key must be pressed to see all the Noun screens. Press the number corresponding to the noun that is to be used as a descriptor for the location of the monitor module currently being programmed.

```

    *****
    1=BASEMENT
    2=BOILER RM
    3=CLASSROOM
    
```

Noun Screen #1

```

    *****
    1=KITCHEN
    2=LOBBY
    3=OFFICE
    
```

Noun Screen #5

```

    *****
    1=CLOSET
    2=CORRIDOR
    3=ELECTRIC RM
    
```

Noun Screen #2

```

    *****
    1=PATIENT
    2=RESTROOM
    3=ROOM
    
```

Noun Screen #6

```

    *****
    1=ELEVATOR
    2=ENTRANCE
    3=FLOOR
    
```

Noun Screen #3

```

    *****
    1=STAIRWAY
    2=STOREROOM
    3=WING
    
```

Noun Screen #7

```

    *****
    1=GARAGE
    2=HALLWAY
    3=HVAC RM
    
```

Noun Screen #4

```

    *****
    1=ZONE
    
```

Noun Screen #8

Pressing 3 or 4 while viewing the Noun/Adjective Screen will display screens similar to the previous Adjective and Noun Screens. The new screens will list Custom Adjectives and Nouns which have been programmed into the control panel using the PS-Tools utility.

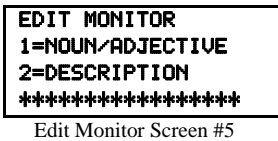

Description

The Description selection allows the programmer to enter additional information about the monitor module currently being programmed. This information will be displayed as part of the device label on the LCD display. Pressing 2 while viewing Edit Monitor Screen #5 will cause the following screen to be displayed:



Noun/Adjective Screen

A flashing cursor will appear at the first asterisk to the left. The programmer can enter additional descriptive information about the device being programmed. This information will appear on the LCD display along with the standard device label information.

A maximum of 20 characters (including spaces) can be entered. To enter alphanumeric characters from the keypad, repeatedly press the appropriate key until the desired character is displayed in the first position. For example, to enter the letter *B*, press the 2 (*ABC*) key three times to toggle through the characters 2, *A* and *B*. Press the right arrow key to move the cursor one position to the right and repeat the process to enter the next character. To enter a space, press the * (*QZ*) key four times until a blank appears in the desired position. When all characters have been entered, press the Enter key to store the information. The display will return to the Edit Monitor Screen #4, displaying the new information at the bottom of the screen.

Recall/Increment Function

In addition, the user may use the Recall/Increment function at any time when the cursor is on the first letter of the Adjective or Noun field as follows:

- If the zero key is pressed, a 0 is placed in the first letter position
- If the zero key is then pressed a second time with no intervening key actions, the entire Adjective field is replaced with the field entered for the previous device programmed, and the cursor moves to the last character of the field (Recall function). The Recalled Adjective or Noun field may now be changed letter-by-letter
- If the zero key is pressed again with no other intervening key actions and the last character in the field is a number 0-9, the number is incremented by one. If the last character is a letter, it changes to a 0. If the last character is 9 it goes to 0
- The above increment function may be repeated with each press of the zero key

As an example, the user could quickly enter 'FLR_3_ROOM 305' as follows:

1. The cursor is on the first letter of the Adjective field. Press the zero key twice to display *FLR_3*
2. With the cursor on the first letter of the Noun field, press the zero key twice to recall the display *ROOM_304*. The cursor automatically jumps from the first to the last letter of the Noun field
3. With the cursor on the last letter of the Noun field, press the zero key again to increment the room number to *305*
4. Press the right arrow key to advance the zone field
5. Select a zone number from 00 to 99. Z00 (default zone) is the general alarm zone. Z01 through Z99 may be selected to link software zones

3.6.2.2.4 Edit Module Screen for Control Modules

The programmer can change a module's existing or factory default programming by pressing 3 in the Modules Screen. The following screen will be displayed:

```

MODULES
1=ADD
2=DELETE
3=EDIT
  
```

Modules Screen

```

          EDIT MODULE
    ENTER MODULE ADDRESS
    ***
  
```

Edit Module Screen

A flashing cursor will appear in the position of the first asterisk to the left.

The programmer keys in the three digit module address, such as *002*. When the last digit is keyed-in, if the selected address corresponds to a *control* module, a screen displaying information about the control module with the selected address will be displayed as illustrated in the following:

```

NORMAL          CONTROL
    <ADJ> <NOUN>
                ZNNN
                SW  1M002
  
```

Edit Control Screen #1

In the preceding example:

- ✓ Normal - indicates that the module with the selected address is physically installed on the SLC and communicating with the control panel (enabled)
- ✓ <ADJ><NOUN> - represents the adjective and noun, which have been programmed, describing the location of the displayed device
- ✓ Control - indicates that the selected module is a control module
- ✓ S or * - represents Silenceable (S) or Nonsilenceable (*)
- ✓ W or * - represents Waterflow Timer Delay (W = Waterflow Timer Delay enabled, * = Waterflow Timer Delay disabled)
- ✓ ZNNN - represents the first of five possible software zones that the module is assigned to (NNN = the three digit zone number from 000 - 099)
- ✓ 1M002 - represents the Loop, Device type and Device address (1 = SLC Loop, M=Module and 002 = Module Address 02)

To change the programming for the displayed module, press the keyboard *down* arrow key to view the following Edit Control screens:

```

EDIT CONTROL
1=ENABLED      YES
2=TYPE CONTROL
3=SILENCEABLE YES
    
```

Edit Control Screen #2

```

EDIT CONTROL
1=WALKTEST     YES
2=ZONE ASSIGNMENT
  00 ** ** ** **
    
```

Edit Control Screen #3

```

EDIT CONTROL
1=NOUN/ADJECTIVE
2=DESCRIPTION
*****
    
```

Edit Control Screen #4

```

EDIT CONTROL
1=ENABLED
2=TYPE
3=SILENCEABLE
    
```

Edit Control Screen #2

Enable/Disable Module

To Enable or Disable the control module, press the *1* key while viewing the Edit Control Screen #2. Each press of the key will toggle the screen between *Enabled Yes* and *Enabled No*. If *Enabled No* is selected, the module will not be polled by the control panel, preventing the module from activating its output devices. The control panel will indicate a system trouble condition and the Disable LED will turn on if any devices are disabled.

EDIT CONTROL 1=ENABLED 2=TYPE 3=SILENCEABLE
--

Edit Control Screen #2

Type

To select the type of control module being programmed, press the 2 key while viewing the Edit Control Screen #2. This will cause the control panel to display the following Control Type Screens. Press the down arrow key to view additional screens and selections.

CONTROL TYPE 1=BLANK 2=BELL-CIRCUIT 3=HORN-CIRCUIT

Control Type Screen #1

While viewing one of the Control Type screens, select the type of control module being programmed by pressing the corresponding keypad number key. The display will return to the Edit Control Screen #2 and indicate the new type selection.

Note: A control relay module set to the Resettable Power type will follow the main circuit board 24 VDC resettable power unless the control relay module is disabled.

The following table contains control module type codes and their functions which are displayed in the Control Type screens:

Control Type	Special Function
Bell Circuit	NAC Type - supervised
Horn Circuit	NAC Type - supervised
Sounders	NAC Type - supervised
Relay	Ignore Open Circuit
Strobe Circuit	NAC Type - supervised
Control	NAC Type - supervised
Resettable Power ¹	Relay Type - Ignore Open Circuit
HVAC SHUTDN ²	Relay Type - Ignore Open Circuit

Note:

1. When using a control relay module to supply resettable power to conventional 2-wire smoke detectors, the addressable monitor module must be programmed for *Smoke-Conventional* operation
2. For HVAC SHUTDN description, refer to "Control Module Operation" on page 208

```

EDIT CONTROL
1=ENABLED
2=TYPE
3=SILENCEABLE
    
```

Edit Control Screen #2

```

EDIT CONTROL
1=WALKTEST
2=ZONE ASSIGNMENT
  00 ** ** ** **
    
```

Edit Control Screen #3

```

EDIT CONTROL
1=NOUN/ADJECTIVE
2=DESCRIPTION
    
```

Edit Control Screen #4

Silenceable

The Silenceable selection allows the programmer to select whether output devices connected to the control module can be silenced, either by pressing the Alarm Silence key or by enabling Autosilence. Pressing the 3 key while viewing Edit Control Screen #2 will enable the Silenceable feature causing the display to read *Silenceable Yes*. Repeated presses of the 3 key will cause the display to toggle between *Silenceable Yes* and *Silenceable No*.

Walktest

The Walktest feature allows one person to test the system devices without the necessity of manually resetting the control panel after each device activation. To enable devices, which are connected to a control module, for the Walktest feature, press 1 while viewing the Edit Control Screen #3 until the display reads *Walktest Yes*. Each press of the 1 key will cause the display to toggle between *Walktest Yes* and *Walktest No*. Refer to "Walktest" on page 167 for additional information.

Zone Assignment

A maximum of five zones can be programmed to each addressable control module. Pressing 2 while viewing Edit Control Screen #3 displays the following screen:

```

          ZONE ASSIGNMENT
        Z00 Z** Z** Z** Z**
    
```

Zone Assignment Screen

Note that Z** represents the Zone Number(s) corresponding to this device. The factory default for an unprogrammed device is Z00 for general alarm zone. A flashing cursor will appear on the first 0 to the left. Enter the two digit number corresponding to the zone that is to be assigned to this device. The cursor moves to the next Z** designation. Continue entering zone assignments or the remaining zones can be left blank or programmed as general alarm zones Z00. When all desired changes have been made, press the Enter key to store the zone assignments. The display will return to the Edit Control Screen #3.

Noun/Adjective

The Noun/Adjective selection allows the programmer to enter specific descriptors about the control module currently being programmed. Pressing 1 while viewing Edit Control Screen #4 will cause the following screen to be displayed:

```

1=STANDARD ADJECTIVE
2=STANDARD NOUN
3=CUSTOM ADJECTIVE
4=CUSTOM NOUN
    
```

Noun/Adjective Screen

1=STANDARD ADJECTIVE
2=STANDARD NOUN
3=CUSTOM ADJECTIVE
4=CUSTOM NOUN

Noun/Adjective Screen

Pressing *1* while viewing the Noun/Adjective Screen will cause the following screen(s) to be displayed. Note that the keyboard *down* arrow key must be pressed to see all the Adjective screens. Press the number corresponding to the adjective that is to be used as a descriptor for the location of the control module currently being programmed.

```
*****  
1=NORTH  
2=SOUTH  
3=EAST
```

Adjective Screen #1

```
*****  
1=3RD  
2=4TH  
3=5TH
```

Adjective Screen #5

```
*****  
1=WEST  
2=FRONT  
3=CENTER
```

Adjective Screen #2

```
*****  
1=FLOOR 1  
2=FLOOR 2  
3=FLOOR 3
```

Adjective Screen #6

```
*****  
1=REAR  
2=UPPER  
3=LOWER
```

Adjective Screen #3

```
*****  
1=FLOOR 4  
2=FLOOR 5  
3=ROOM
```

Adjective Screen #7

```
*****  
1=MAIN  
2=FIRST  
3=2ND
```

Adjective Screen #4

1=STANDARD ADJECTIVE
2=STANDARD NOUN
3=CUSTOM ADJECTIVE
4=CUSTOM NOUN

Noun/Adjective Screen

Pressing 2 while viewing the Noun/Adjective Screen will cause the following screen(s) to be displayed. Note that the keyboard *down* arrow key must be pressed to see all the Noun screens. Press the number corresponding to the noun that is to be used as a descriptor for the location of the control module currently being programmed.

```
*****  
1=BASEMENT  
2=BOILER RM  
3=CLASSROOM
```

Noun Screen #1

```
*****  
1=KITCHEN  
2=LOBBY  
3=OFFICE
```

Noun Screen #5

```
*****  
1=CLOSET  
2=CORRIDOR  
3=ELECTRIC RM
```

Noun Screen #2

```
*****  
1=PATIENT  
2=RESTROOM  
3=ROOM
```

Noun Screen #6

```
*****  
1=ELEVATOR  
2=ENTRANCE  
3=FLOOR
```

Noun Screen #3

```
*****  
1=STAIRWAY  
2=STOREROOM  
3=WING
```

Noun Screen #7

```
*****  
1=GARAGE  
2=HALLWAY  
3=HVAC RM
```

Noun Screen #4

```
*****  
1=ZONE
```

Noun Screen #8

Pressing 3 or 4 while viewing the Noun/Adjective Screen will display screens similar to the previous Adjective and Noun Screens. The new screens will list Custom Adjectives and Nouns which have been programmed into the control panel using the PS-Tools programming utility.

```

EDIT CONTROL
1=ADJECTIVE/NOUN
2=DESCRIPTION

```

Edit Control Screen #4

Description

The Description selection allows the programmer to enter additional information about the control module currently being programmed. This information will be displayed as part of the device label on the display. Pressing 2 while viewing Edit Control Screen #4 will cause the following screen to be displayed:

```

DESCRIPTION      1M002
NOUN/ADJECTIVE

*****

```

Adjective/Noun Screen

A flashing cursor will appear at the first asterisk to the left. The programmer can enter additional descriptive information about the device being programmed. This information will appear on the display along with the standard device label information.

A maximum of 20 characters (including spaces) can be entered. To enter alphanumeric characters from the keypad, repeatedly press the appropriate key until the desired character is displayed in the first position. For example, to enter the letter *B*, press the 2 (*ABC*) key three times to toggle through the characters *I*, *A* and *B*. Press the right arrow key to move the cursor one position to the right and repeat the process to enter the next character. To enter a space, press the * (*QZ*) key four times until a blank appears in the desired position. When all characters have been entered, press the Enter key to store the information. The display will return to the Edit Control Screen #4, displaying the new information at the bottom of the screen.

Recall/Increment Function

In addition, the user may use the Recall/Increment function at any time when the cursor is on the first letter of the Adjective or Noun field as follows:

- If the zero key is pressed, a 0 is placed in the first letter position
- If the zero key is then pressed a second time with no intervening key actions, the entire Adjective field is replaced with the field entered for the previous device programmed, and the cursor moves to the last character of the field (Recall function). The Recalled Adjective or Noun field may now be changed letter-by-letter
- If the zero key is pressed again with no other intervening key actions and the last character in the field is a number 0-9, the number is incremented by one. If the last character is a letter, it changes to a 0. If the last character is 9 it goes to 0
- The above increment function may be repeated with each press of the zero key

As an example, the user could quickly enter 'FLR_3_ROOM 305' as follows:

1. The cursor is on the first letter of the Adjective field. Press the zero key twice to display *FLR_3*
2. With the cursor on the first letter of the Noun field, press the zero key twice to recall the display *ROOM_304*. The cursor automatically jumps from the first to the last letter of the Noun field
3. With the cursor on the last letter of the Noun field, press the zero key again to increment the room number to *305*
4. Press the right arrow key to advance the zone field
5. Select a zone number from 00 to 99. Z00 (default zone) is the general alarm zone. Z01 through Z99 may be selected to link software zones

3.6.3 Zone Setup

```

PROGRAMMING
1=AUTO PROGRAM
2=POINT PROGRAM
3=ZONE SETUP
    
```

Programming Screen #2

Pressing 3 while viewing Programming Screen #2 will access the Zone Setup screens as illustrated below:

```

ZONE SETUP
1=ENABLE
2=DISABLE
3=ZONE 97 98 99
    
```

Zone Setup Screen #1

```

ZONE SETUP
1=ZONES INSTALLED
2=ZONES ENABLED
3=ZONES DISABLED
    
```

Zone Setup Screen #2

```

ZONE SETUP
1=ZONE TYPES
2=ZONES AVAILABLE
3=ZONE MESSAGE
    
```

Zone Setup Screen #3

```

ZONE SETUP
1=ENABLE
2=DISABLE
3=ZONE 97 98 99
    
```

Zone Setup Screen #1

3.6.3.1 Enable

Pressing 1 for Enable, while viewing Zone Setup Screen #1, will display the following screen:

```

ZONE TO ENABLE
Z
    
```

Enable Screen

This screens allows the programmer to enable zones, one at a time. A flashing cursor appears next to the Z, prompting the programmer to enter a two digit zone number (01 - 99). When the second digit is entered, the zone will be enabled and the cursor returns to the original position next to the Z. Another zone can then be enabled.

ZONE SETUP
1=ENABLE
2=DISABLE
3=ZONE 97 98 99

Zone Setup Screen #1

3.6.3.2 Disable

Pressing 2 for Disable, while viewing Zone Setup Screen #1, displays the following:

ZONE TO DISABLE
Z █

Disable Screen

This screen allows the programmer to disable zones, one at a time. A flashing cursor appears next to the Z, prompting the programmer to enter a two digit zone number (01 - 99). When the second digit is entered, the zone will be disabled and the cursor will return to the original position next to the Z. Another zone can then be disabled.

3.6.3.3 Zone 97, 98 and 99

Pressing 3 for Zone 97, 98 and 99, while viewing Zone Setup Screen #1, will display the following screen:

SPEC PURPOSE ZONE
1=PAS 97 OFF
2=PRE SIGNAL 98 OFF
3=TWO STAGE 99 OFF

Zone 97, 98 and 99 Screen

Zones 97, 98 and 99 can be programmed for normal zone operation or for special purpose applications. In the above illustration, the three zones are shown Off, which means they can be programmed to function in the same manner as all other zones, by assigning them to input and output devices in the Programming Zone Assignment Screen.

Pressing 1 will cause the display to change to *PAS 97 On*. Each press of the 1 key will cause the display to toggle between *PAS 97 On* and *PAS 97 Off*. When Zone 97 is programmed On, a PAS (Positive Alarm Sequence) activation of any smoke detector will cause Zone 97 to activate. By assigning Zone 97 to a control module in the Programming Zone Assignment Screen, an output device connected to the control module can be used to indicate a PAS condition in the control panel. *Do not assign Zone 97 to a Notification Appliance Circuit when using this zone to indicate a PAS condition. Attempting to do so will generate an error message and will be prevented by software checks.*

Pressing 2 will cause the display to change to *Pre-signal 98 On*. Each press of the 2 key will cause the display to toggle between *Pre-signal 98 On* and *Pre-signal 98 Off*. When Zone 98 is programmed On, a Pre-signal activation of any device will cause Zone 98 to activate. By assigning Zone 98 to a control module in the Programming Zone Assignment Screen, an output device connected to the control module can be used to indicate a Pre-signal condition in the control panel. *Do not assign Zone 98 to a Notification Appliance Circuit when using this zone to indicate a Pre-signal condition. Attempting to do so will generate an error message and will be prevented by software checks.*

Pressing 3 will cause the display to change to *Two Stage 99 On*. Each press of the 3 key will cause the display to toggle between *Two Stage 99 On* and *Two Stage 99 Off*. Refer to "Two Stage Operation" on page 108 for a description of this feature.

<p>ZONE SETUP 1=ZONES INSTALLED 2=ZONES ENABLED 3=ZONES DISABLED</p>

Zone Setup Screen #2

3.6.3.4 Zones Installed

Pressing 1 for Zones Installed, while viewing Zone Setup Screen #2, will display a screen similar to the following:

<p>ZONES INSTALLED 00 01 02 03 04 05</p>

Zones Installed Screen

This display will show all of the zones that have been programmed into the control panel. Note that an up and/or down arrow may appear in the upper right corner of the display, indicating that additional screens of zone information exists. Press the up or down arrow keys to view the additional zones.

3.6.3.5 Zones Enabled

Pressing 2 for Zones Enabled, while viewing Zone Setup Screen #2, will display a screen similar to the following:

<p>ZONES ENABLED </p> <p>00 01 02 04 05 06 07 08 09 10 11 12 13 14 15 16 17 18 19 20 21</p>
--

Zones Enabled Screen

This display will show all of the zones that are enabled in the control panel. Note that an up and/or down arrow may appear in the upper right corner of the display, indicating that additional screens of zone information exists. Press the up or down arrow keys to view the additional zones.

3.6.3.6 Zones Disabled

Pressing 3 for Zones Disabled, while viewing Zone Setup Screen #2, will display a screen similar to the following:

<p>ZONES DISABLED 03</p>

Zones Disabled Screen

This display will show all of the zones that are disabled in the control panel. Note that an up and/or down arrow may appear in the upper right corner of the display, indicating that additional screens of zone information exists. Press the up or down arrow keys to view the additional zones.

```

ZONE SETUP
1=ZONE TYPES
2=ZONES AVAILABLE
3=ZONE MESSAGE
    
```

Zone Setup Screen #3

3.6.3.7 Zone Type

Zone Types must be programmed only if a DACT, programmed for zone reporting, is installed on the control panel. Pressing 1 for Zone Types, while viewing Zone Setup Screen #3, will display a screen similar to the following:

```

ZONE TYPE PROG
1=Z00 MONITOR
2=Z01 MONITOR
3=Z02 MONITOR
    
```

Zones Installed Screen

This display will show the system zones (default and user programmed) and their associated types. Note that an up and/or down arrow will appear in the upper right corner of the display, indicating that additional screens of zone information exists. Press the up or down arrow keys to view zones Z00 through Z99.

Zone types can be changed by pressing the keypad number key corresponding to the zone in each Zones Installed Screen. Available zone types will be displayed in the resultant screens. For example, to change the zone type for zone Z02 in the screen illustrated above, press 3. The following screens will be displayed:

```

ZONE TYPE PROG
1=MONITOR
2=SMOKE PHOTO
3=WATERFLOW
    
```

Zone Type Program Screen #1

```

ZONE TYPE PROG
1=MEDICAL
2=HAZARD
3=TAMPER
    
```

Zone Type Program Screen #3

```

ZONE TYPE PROG
1=HEAT
2=PULL STATION
3=DUCT
    
```

Zone Type Program Screen #2

```

ZONE TYPE PROG
1=SUPERVISORY
2=PROC. MON
3=SMOKE ION
    
```

Zone Type Program Screen #4

To change the zone type for Z02 to Pull Station, scroll the display until Zone Type Program Screen #2 is displayed. Press 2 to program zone Z02 as a Pull Station zone. The display will return to the Zones Installed Screen showing zone Z02 and the Pull Station program type. Repeat the procedure for each zone to be changed.

IMPORTANT! In Zone Type Program Screen #1, selecting WATERFLOW will assign a Waterflow silenceable zone type to the selected zone. Any signaling devices programmed to the same zone can be silenced by pressing the Alarm Silence key or by using the auto-silence feature.

To program a waterflow circuit as nonsilenceable, refer to "System Setup" on page 97.

Note: Zone Types are only relevant for Central Station reporting. Changing a zone type will only change how it is reported to the Central Station.

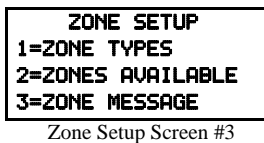

3.6.3.8 Zones Available

Pressing 2 while viewing Zone Setup Screen #3 will display the following screen:

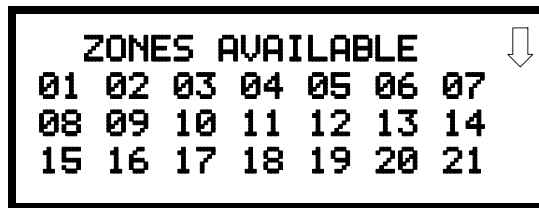

The display will show all of the zones that are still available for programming. Note that an up and/or down arrow may appear in the upper right corner of the display, indicating that additional screens of zone information exists. Press the up or down arrow key to view additional screens.

3.6.3.9 Zone Message

Pressing 3 while viewing Zone Setup Screen #3 will display the following screen:



Pressing the down arrow key will display additional screens for Zones up to Z99. Press the number key corresponding to the Zone to be programmed. Screens will be displayed allowing the programmer to select Audio Messages 1 through 5. When an audio message is selected, the display will return to the Zone Message screen, showing the message selected for that particular zone. In the example above, Zone 01 has been programmed for Audio Message 1.

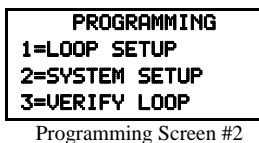

3.6.4 Loop Setup

Loop Setup allows the programmer to configure the SLC Loop for NFPA Style 4, 6 or 7 wiring and to select the loop protocol. Pressing 1 while viewing Programming Screen #2 will cause the following screen to be displayed:



Loop Setup Screen

3.6.4.1 Style

To program the SLC Style for the selected loop, press 1 for Style, while viewing Loop Setup Screen. In the preceding example, the control panel is programmed for Style 4 SLC wiring as indicated by the 4 to the right of Style in the display. To change the wiring style, press 1 to toggle the display to read Style 6. Each press of the 1 key will cause the display to toggle between Style 4 and Style 6. Note that, when programming the Loop Style, the programmer can only select between Style 4 and Style 6. To program a system for Style 7 wiring, the programmer must select the Loop Setup for Style 6. Style 7 wiring is the same as Style 6 with the added requirement that each addressable device on the loop must have a pair of isolator modules, one on each side.

Note on SLC Troubles: If the FACP reports an open fault on an SLC Loop programmed for Style 6, the trouble condition will latch at the FACP. When the SLC Loop has been repaired, the *Reset* button must be pressed at the FACP (at least 2 minutes after the trouble has been repaired) to clear the SLC trouble.

3.6.4.2 Loop Protocol

Loop Protocol refers to the SLC loop mode of operation. Refer to "Wire Requirements" on page 205 for wire specifications based upon SLC protocol. There are two Loop Protocols available:

- CLIP (Classic Loop Interface Protocol) - which is used for the older legacy addressable devices such as the M300 Series modules and detectors.
- LiteSpeed (factory default setting) - used for the 350 Series or newer addressable devices for quicker response times. Note that the legacy devices can operate only in CLIP mode while the newer devices are compatible with CLIP and LiteSpeed modes of operation.

Pressing 2 while viewing the Loop Setup Screen will toggle between CLIP and LiteSpeed Protocols.

Device Addressing

It is important to note that the MS-9200UDLS addressable device capacity is 99 detectors and 99 control/monitor modules. Newer devices can be set to addresses higher than 99 but these addresses will not function with the MS-9200UDLS.

Note that It is permissible to mix old and new devices on the same loop but the FACP must be set for CLIP mode when older devices are installed.

3.6.5 System Setup

System Setup allows the programmer to configure the following control panel features:

- *Trouble Reminder:* This feature, when enabled, provides an audible reminder that an alarm or trouble still exists on the FACP after the control panel has been silenced. The control panel piezo sounder will pulse once every 15 seconds during an alarm and every two minutes during a trouble condition, after the Alarm Silence or Acknowledge key is pressed. The piezo will continue to sound at these rates until the alarm or trouble condition is cleared. If the trouble condition is not cleared within 24 hours, the panel will reactivate the trouble sounder and retransmit the trouble condition to the central station if connected.
- *Banner:* This option allows the user to change the top two lines of the LCD display from the blank factory default readout to a user defined readout when the control panel is in Normal condition.
- *Time-Date:* This feature allows the programmer to set the time, display format (24 hr or 12 hr), date and daylight savings time feature into the FACP memory
- *Timers:* This option allows the programmer to set the PAS (Positive Alarm Sequence) time delay, Pre-Signal time delay and Waterflow time delay.
- *NACs:* This feature allows the programmer to configure the control panel Notification Appliance Circuits for a variety of options, such as circuit type, silenceable/nonsilenceable, autosilence, coding, silence inhibit, zone assignment and enable/disable.
- *Relays:* This option allows programming of two onboard relays for activation by various control panel events, such as alarm, trouble, supervisory, etc.
- *Canadian Option:* This option allows the automatic programming of ionization smoke detector sensitivity thresholds to Canadian specifications.
- *Waterflow Silenceable:* This option provides the ability to silence any output circuit activated by a monitor module programmed as a waterflow type.

PROGRAMMING
1=LOOP SETUP
2=SYSTEM SETUP
3=VERIFY LOOP
 Programming Screen #2

Pressing 2 for System Setup, while viewing Programming Screen #2, will cause the following screens to be displayed:

SYSTEM SETUP ↓
1=TROUBLE REM OFF
2=BANNER
3=TIME-DATE

System Setup Screen #1

SYSTEM SETUP ⇕
1=TIMERS
2=NAC
3=RELAYS

System Setup Screen #2

SYSTEM SETUP ↑
1=CANADIAN OPT. OFF
2=WATERFLOW SIL. NO

System Setup Screen #3

3.6.5.1 Trouble Reminder



See Page

The Trouble Reminder features causes the control panel piezo to sound a reminder 'beep' for alarms and troubles, after the panel has been silenced. Refer to "System Setup" on page 97, for a detailed description of this feature. Pressing 1 while viewing System Setup Screen #1 will cause the display to toggle to *Trouble Rem On*, which enables this feature. Each press of the 1 key will cause the display to toggle between *Trouble Rem On* and *Trouble Rem Off*.

3.6.5.2 Banner

The top line of the display, which appears when the control panel is in normal mode, can be changed by using the Banner option. Pressing 2 while viewing System Setup Screen #1 will cause the following to be displayed:

BANNER
1=FACTORY
2=USER DEFINED

Banner Screen

BANNER
1=FACTORY
2=USER DEFINED
 Banner Screen

Pressing 1 while viewing the Banner Screen will select the blank factory default banner setting and display the following screen:

FACTORY BANNER

Factory Banner Screen

Pressing the Enter key will store this selection in nonvolatile memory and return the display to the Banner Screen.

Pressing 2 while viewing the Banner Screen will cause the following screens to be displayed:

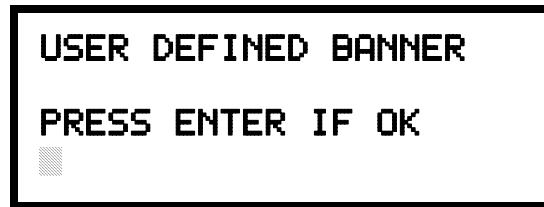

User Defined Banner Screen #1



User Defined Banner Screen #2

These screens allow the programmer to enter a two line custom banner. A flashing cursor will appear in the bottom left corner of each display. A maximum of 20 characters (including spaces) can be entered into each screen for a total of two lines with 40 characters. After entering up to 20 characters in the first screen, press *Enter* to view the second screen. Enter up to 20 characters in the second screen in the same manner or just press *Enter* if a second banner line is not being entered. To quickly clear the current banner, press the *CLR* key.

To enter alphanumeric characters from the keypad, repeatedly press the appropriate key until the desired character is displayed in the first position. For example, to enter the letter *B*, press the 2 (*ABC*) key three times to toggle through the characters *I*, *A* and *B*. Press the right arrow key to move the cursor one position to the right and repeat the process to enter the next character. To enter a space, press the * (*QZ*) key four times to place a blank in the desired position. When all characters have been entered, press the *Enter* key to store the information. The display will return to the Banner Screen.

```

SYSTEM SETUP
1=TROUBLE REM
2=BANNER
3=TIME-DATE
System Setup Screen #1
    
```

3.6.5.3 Time-Date

The control panel time and date can be changed by pressing 3 while viewing the System Setup Screen #1. The following screen will be displayed:

```

TIME AND DATE
1=TIME 10:00 AM
2=DATE 04-07-2006
3=CLOCK FORMAT 12HR
    
```

Time-Date Screen #1

```

TIME AND DATE
1=DAYLIGHT SAVINGS
    
```

Time-Date Screen #2

3.6.5.3.1 Time

To change the time, press 1 while viewing the Time-Date Screen. The following screen will be displayed:

```

ENTER TIME
10:00 AM
1=AM 2=PM
    
```

Time Screen

A flashing cursor is located toward the top left of the display. Below the cursor is the current time. To change the time, enter the two-digit hours followed by the two-digit minutes. The cursor will move one position to the right each time a digit is entered. After the last minutes digit is entered, the cursor will again move one position to the right. At this point enter 1 for AM or 2 for PM. The display will then return to the Time-Date Screen which will show the new time entry. If an error is made while entering a digit, press the CLR key to delete the entire entry and beginning again.

3.6.5.3.2 Date

To change the date, press 2 while viewing the Time-Date Screen. The following screen will be displayed:



Date Screen

A flashing cursor is located toward the top left of the display. Below the cursor is the current date. To change the date, enter the two-digit month followed by the two-digit day and then the two-digit year (01 for 2001, 02 for 2002, etc.). The cursor will move one position to the right each time a digit is entered. After the last year digit is entered, the display will return to the Time-Date Screen which will show the new date entry. If an error is made while entering a digit, press the *CLR* key to delete the entire entry and beginning again.

3.6.5.3.3 Clock Format

The clock can be configured to display 12 hour (AM & PM) or 24 hour (military) time. Pressing 3 while viewing the Time-Date screen will cause the display to toggle between 12HR and 24HR. Select 12HR for 12 hour display or 24HR for 24 hour display.

Note: If the clock is changed to 24 hour (military) format, the date will change to the European standard of Day-Month-Year (for display purposes only).

3.6.5.3.4 Daylight Savings Time

Pressing 1 while viewing Time-Date Screen #2 will cause the following screens to be displayed:



Time & Date Screen #2



Daylight Savings Screen #1



Daylight Savings Screen #2

Pressing 1 while viewing Daylight Savings Screen #1 will cause the display to toggle between *Enabled Yes* and *Enabled No*. The control panel will automatically update the time for daylight savings time when *Enabled Yes* is selected.

Pressing 2 while viewing Daylight Savings Screen #1 will display another screen which allows the programmer to select the month that daylight savings time will begin. In this sub-screen, pressing 1 will select March, 2 will select April and 3 will select May.

Pressing 3 while viewing Daylight Savings Screen #1 will display two sub-screens which allow the programmer to select the week of the month that daylight savings time will begin. In the first sub-screen, pressing 1 will select the first week, 2 will select the second week and 3 will select the third week, while in the second sub-screen, pressing 1 will select the fourth week and 2 will select the last week of the selected month.

Pressing 1 while viewing Daylight Savings Screen #2 will display another screen which allows the programmer to select the month that daylight savings time will end. In this sub-screen, pressing 1 will select September, 2 will select October and 3 will select November.

Pressing 2 while viewing Daylight Savings Screen #2 will display two sub-screens which allow the programmer to select the week of the month that daylight savings time will end. In the first sub-screen, pressing 1 will select the first week, 2 will select the second week and 3 will select the third week, while in the second sub-screen, pressing 4 will select the fourth week and 5 will select the last week of the selected month.

```

SYSTEM SETUP
1=TIMERS
2=NAC
3=RELAYS
    
```

System Setup Screen #2

3.6.5.4 Timers

Timer delays for PAS, Pre-signal and waterflow activation can be programmed by pressing 1 while viewing System Setup Screen #2. The following screen will be displayed:

```

          TIMERS
1=PAS DELAY    000
2=PRE SIGNAL   000
3=WATERFLOW    000
    
```

Timer Screen #1

```

          TIMERS
1=AC LOSS DELAY 000
    
```

Timer Screen #2

```

TIMERS
1=PAS DELAY    000
2=PRE SIGNAL   000
3=WATERFLOW    000
    
```

Timer Screen #1

3.6.5.4.1 PAS (Positive Alarm Sequence) Delay

The factory default setting for PAS is 000 for no delay. To select a PAS delay of 001 to 180 seconds for all devices programmed for PAS, press 1 while viewing Timer Screen #1. The following display will appear:

```

          PAS DELAY
RANGE 0-180 SECONDS
    
```

PAS Delay Screen

A flashing cursor is positioned in the lower left corner of the display. Enter a delay time consisting of three digits, such as 005 for five seconds. Upon entering the third digit, the time delay will be stored in the control panel memory and the display will return to the Delay Screen which will indicate the new delay time.

3.6.5.4.2 Pre-signal Delay

The factory default setting for Pre-signal delay is 000 for no delay. To select a Pre-signal delay of 001 to 180 seconds for all devices programmed for Pre-signal, press 2 while viewing Timer Screen #1. The following screen will be displayed:



Pre-signal Delay Screen

A flashing cursor is positioned in the lower left corner of the display. Enter a delay time consisting of three digits, such as 009 for nine seconds. Upon entering the third digit, the time delay will be stored in the control panel memory and the display will return to the Delay Screen which will indicate the new delay time.

Note that the FACP allows programming for PAS and Pre-signal timers, but a detector can only be programmed for either PAS or Pre-signal operation. Refer to "Edit Detector" on page 66 for programming details.

TIMER	
1=PAS DELAY	000
2=PRE SIGNAL	000
3=WATERFLOW	000

Timer Screen #1

3.6.5.4.3 Waterflow Delay

A delay can be added prior to declaring a waterflow type of alarm. Be careful to include any built-in delays of the waterflow device. The factory default setting for Waterflow delay is 000 for no delay. To select a Waterflow delay of 01 to 90 seconds for all devices programmed for Waterflow delay, press 3 while viewing Timer Screen #1. The following screen will be displayed:



Waterflow Delay Screen

A flashing cursor is positioned in the lower left corner of the display. Enter a delay time consisting of two digits, such as 25 for twenty-five seconds. Upon entering the second digit, the time delay will be stored in the control panel memory and the display will return to the Delay Screen which will indicate the new delay time.

```
TIMER
1=AC LOSS DELAY
```

Timer Screen #2

3.6.5.4.4 AC Loss Delay

The reporting of a loss of AC power to a central station can be delayed by programming the length of the desired delay. The factory default setting is 2 hours. Press *1* while viewing Timer Screen #2 to display the following:

```
AC LOSS DELAY
1=NO DELAY
2=ENTER DELAY
```

AC Loss Delay Screen #1

Pressing *1* while viewing AC Loss Delay Screen #1 will program the FACP to transmit an AC Loss report immediately to the central station.

Pressing *2* while viewing AC Loss Delay Screen #1 will display the following:

```
AC LOSS DELAY
RANGE 00-23
█
```

AC Loss Delay Screen #2

A flashing cursor will appear in the lower left corner of the display. Type the two digit AC loss reporting delay in hours (00 to 23 hour delay). When the second digit is entered, the display will return to AC Loss Delay Screen #1.

Note: Upon the loss of AC power at the control panel, relays programmed for 'AC Loss' will transfer immediately, regardless of the AC Loss Delay setting. If no trouble exists at the panel other than AC Loss, the System Trouble relay will delay its activation for the duration of the AC Loss Delay setting.

```
SYSTEM SETUP
1=TIMERS
2=NAC
3=RELAYS
```

System Setup Screen #2

3.6.5.5 NAC (Notification Appliance Circuit)

The options for the NACs on the control panel main circuit board can be configured by pressing *2* while viewing System Setup Screen #2. The following screens will be displayed:

```
          NACS
1=NAC 1      3=NAC 3
2=NAC 2      4=NAC 4
```

NAC Selection Screen

The Notification Appliance Circuits can be configured independently by pressing *1* for NAC 1, *2* for NAC 2, *3* for NAC 3 or *4* for NAC 4.

Note that 3=NAC 3 and 4=NAC 4 will be displayed, and can be programmed, regardless of how the NACKEY card is installed. Their programming, however, will have no effect if the NACKEY card is installed for Class A operation.

The following screens will be displayed for each selection:

NAC #		↓
1=ENABLED		YES
2=TYPE		BELL
3=SILENCEABLE		YES

NAC Screen #1

NAC #		↕
1=AUTO SILENCE		00
2=CODING		TEMPORAL

NAC Screen #2

NAC #		↕
1=ZONE		
	00 00 00 00 00	
2=SIL INHIBITED		NO

NAC Screen #3

NAC #		↑
1=SYNC TYPE		S

NAC Screen #4

3.6.5.5.1 Enabled

Pressing *1* while viewing NAC Screen #1 will cause the display to change to *Enabled No*. This will prevent the selected main circuit board NAC from activating its devices. Each press of the *1* key will cause the display to toggle between *Enabled Yes* and *Enabled No*.

Note: The programming for NAC 1 will determine the operation of the remote power supply sync.

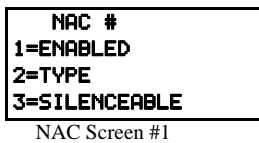

3.6.5.5.2 Type

The main circuit board NAC type can be programmed by pressing 2 while viewing NAC Screen #1. The following screen will be displayed. Press the down arrow key to view additional screens:

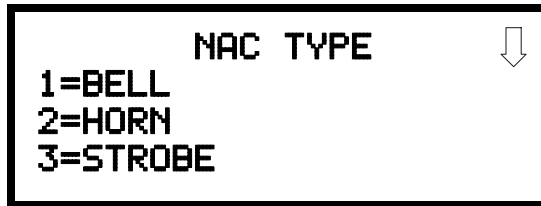

Type Screen #1

Select the NAC device type by pressing the number corresponding to the type in the appropriate screen. When the selection is made, the display will return to NAC Screen #1.

The following table contains NAC type codes and their functions:

NAC Type Code	Special Function
Bell	None
Horn	None
Strobe	None
Synced Strobe	Synchronized to manufacturer
Strobe Sil Sync	Same as Synced Strobe but Silence turns off audible & visual devices
Future Use	None
Future Use	None
Future Use	None
Blank	None

3.6.5.5.3 Silenceable

Pressing 3 while viewing NAC Screen #1 will cause the display to change to *Silenceable No*. This will prevent the selected main circuit board NAC from being silenced by pressing the Alarm Silence key or by the Auto Silence feature. Each press of the 3 key will cause the display to toggle between *Silenceable Yes* and *Silenceable No*.

Important: *When a Notification Appliance Circuit with a mix of audible and visual devices is programmed for silenceable and the **Synced Strobe** feature is selected, only the audible devices will be turned off if the Silence key is pressed or if the Autosilence feature is enabled. The visual devices (strobes, etc.) will continue to operate. If the **Strobe Sil Sync** feature is selected, Silence or Autosilence will turn off both audible and visual devices.*

<p>NAC # 1=AUTO SILENCE 2=CODING TEMPORAL</p>
--

NAC Screen #2

3.6.5.5.4 Auto Silence

The Auto Silence feature, when enabled, automatically silences all main circuit board silenceable notification appliances after a programmed length of time. To enable this feature and program the time delay before Auto Silence activation, press *1* while viewing NAC Screen #2. The following screens will be displayed:

<p>AUTO SILENCE 1=NO 2=5 MINUTES 3=10 MINUTES</p>	↓
--	---

Auto Silence Screen #1

<p>AUTO SILENCE 1=15 MINUTES 2=20 MINUTES 3=25 MINUTES</p>	↕
---	---

Auto Silence Screen #2

<p>AUTO SILENCE 1=30 MINUTES</p>	↑
---------------------------------------	---

Auto Silence Screen #3

To disable the Auto Silence feature, press *1* for *No* while viewing Auto Silence Screen #1. To enable the Auto Silence feature, press the number corresponding to the time delay which will elapse before Auto Silence activates. This information will be stored in memory and the display will return to NAC Screen #2.

Note: All silenceable control modules as well as the remote power supply sync will be controlled by the Autosilence timer for NAC 1.

3.6.5.5.5 Coding (only for NACs not programmed as Sync Strobe Type)

The Coding feature allows the programmer to select the type of output that the main circuit board notification appliances will generate when activated. Pressing *2* while viewing NAC Screen #2 will cause the following displays to appear:

<p>CODING 1=STEADY 2=MARCH TIME 3=CALIFORNIA</p>	↓
---	---

Coding Screen #1

<p>CODING 1=TEMPORAL 2=TWO STAGE 3 MIN 3=TWO STAGE 5 MIN</p>	↑
---	---

Coding Screen #2

The programmer can select the notification appliance output by pressing the number corresponding to the desired output. The coding selections are:

- Steady - a continuous output with no coding
- March Time - 120 ppm (pulse-per-minute) output
- California - 10 seconds on and 5 seconds off
- Temporal - ½ second on, ½ second off, ½ second on, ½ second off, ½ second on, 1½ second off
- Two Stage - refer to "Two Stage Operation" on page 108 for a description

Selection of one of the above options will cause the control panel to store the information in memory and return the display to NAC Screen #2, which will display the new coding choice.

3.6.5.5.1 Two Stage Operation

Two Stage operation consists of the following:

- 1st stage output - 20 ppm (pulse-per-minute) coding
- 2nd stage output - Temporal coding as described above

If Two Stage operation is programmed as the Coding option, the following sequence of events will occur during an alarm.

1. The on-board NACs which are programmed to General Alarm Zone 0 will activate with a 1st stage output upon activation of any alarm point
2. If the activated alarm point is directly mapped to a zone which is programmed to an on-board NAC, that NAC will go directly to 2nd stage coding output. All other NACs not directly mapped to the activated alarm point's zone but assigned to Zone 0 will activate with a 1st stage output
3. If, after the programmed time of 3 or 5 minutes, the Acknowledge switch has not been pressed, all NACs presently in 1st stage activation will go to 2nd stage activation
4. If an Acknowledge switch has been pressed, any NACs currently in 1st stage activation will remain in 1st stage. Pressing the Acknowledge switch does not affect NACs already in 2nd stage activation
5. If another alarm point is activated and the countdown timer is counting, the alarm point will have no effect on the NACs unless the alarm point's zones are directly mapped to one of the NACs, in which case it will follow the procedure outlined in step 2
6. If another alarm point is activated and the countdown timer has stopped counting due to the Acknowledge switch being pressed, the countdown timer will restart and the NACs will respond as outlined in step 2. NACs already in 2nd stage activation will not be affected
7. Any control modules assigned to special Zone 99 will be activated either by direct mapping of an input device programmed to Zone 99 or if the timer counts down to zero or when any NAC goes into 2nd stage coding
8. Control modules that are programmed to the same zone as the activated input device will not be delayed for activation

```

NAC #
1=ZONE
  00 00 00 00 00
2=SIL INHIBITED NO
NAC Screen #3

```

3.6.5.5.6 Zone

A maximum of five zones can be programmed to each main circuit board NAC. Pressing *1* while viewing NAC Screen #3 displays the following screen:

```

ZONE ASSIGNMENT
Z00 Z** Z** Z** Z**

```

Zone Screen

Note that *Z*** represents the Zone Number(s) corresponding to the selected NAC. The factory default for an unprogrammed device is *Z00* for general alarm zone. A flashing cursor will appear on the first *0* to the left. Enter the two digit number corresponding to the zone that is to be assigned to this NAC. The cursor moves to the next *Z*** designation. Continue entering zone assignments or the remaining zones can be left blank or programmed as general alarm zone *Z00*. When all desired changes have been made, press the Enter key to store the zone assignments. The display will return to the NAC Screen #3 which will show the zone assignments just entered.

3.6.5.5.7 Silence Inhibited

The Silence Inhibit feature, when enabled, prevents the silencing of the selected main circuit board NAC for a period of one minute. Resetting the FACP will also be prevented for one minute while the NAC programmed for silence inhibit is activated. Pressing *2* while viewing NAC Screen #3 will cause the display to change from the factory default of *Silence Inhibit No* to *Silence Inhibit Yes*. Each press of the *2* key will cause the display to toggle between the two options.

```

NAC #
1=SYNC TYPE
NAC Screen #4

```

3.6.5.5.8 Sync Type

If synchronized strobes were selected as the Type of device installed, the type of synchronization must be selected in this option. Pressing *1* while viewing NAC Screen #4 will cause the following screen to be displayed:

```

NAC SYNC TYPE
1=SYSTEM SENSOR
2=WHEELOCK
3=GENTEX

```

Pressing *1* while viewing this screen will select System Sensor synchronization, *2* will select Wheelock and *3* will select Gentex.

3.6.5.5.8.1 Maximum Number of Strobes for Synchronization

The total current draw for each Notification Appliance Circuit cannot exceed 2.5 amps. Refer to the manufacturer's documentation supplied with the Strobes to determine the maximum current draw for each strobe and ensure that the circuit maximum is not exceeded.

To ensure proper strobe and circuit operation, there is also a limit to the number of strobes that can be attached to each circuit. Following is a list of the strobes that have been tested with this FACP and the maximum number that can be connected to each NAC. Make sure that the NAC maximum current is not exceeded:

- ✓ System Sensor: 40 Strobes
- ✓ Wheelock: 25 Strobes
- ✓ Gentex: 23 Strobes

```

SYSTEM SETUP
1=TIMERS
2=NAC
3=RELAYS
    
```

System Setup Screen #2

3.6.5.6 Relays

Pressing 3 while viewing System Setup Screen #2 will allow the programmer to configure two main circuit board Form-C relays from the following screen:

```

RELAYS
1=RELAY 1
2=RELAY 2
3=RELAY 3
    
```

Relays Selection Screen

To program Relay 1 or Relay 3, press the number corresponding to the selected relay. Note that Relay 2 is fixed as a Trouble relay. Selecting Relay 2 will have no effect on its programming. The following screen will appear for each relay to be programmed:

```

RELAY #
1=TYPE
ALARM
    
```

Relay Type Screen

Pressing 1 for Type while viewing the Relay Screen will cause the following screens to be displayed:

```

RELAY
1=ALARM
2=SUPERVISORY
3=SUPERVISORY AR
    
```

Relay Screen #1

```

RELAY
1=PROCESS MON AR
2=AC LOSS
3=HAZARD
    
```

Relay Screen #3

```

RELAY
1=TROUBLE
2=COMM FAIL
3=PROCESS-MON
    
```

Relay Screen #2

```

RELAY
1=MEDICAL
2=SILENCEABLE ALARM
    
```

Relay Screen #4

While viewing the selected screen, press the number corresponding to the desired relay type to program the main circuit board relay. The choice will be stored in memory and the display will return to the Relay Type Screen which will show the programmed type choice. Press the Escape key to return to the Relays Selection Screen and repeat the preceding procedure for the remaining relays.

Notes:

1. *AR (AutoResettable)* in *SUPERVISORY AR* and *PROCMON AR* means that a relay with the Supervisory and/or Process Monitor type code, when activated, will automatically reset when the corresponding condition is cleared.
2. A relay programmed with the Silenceable Alarm type will activate upon any alarm and **deactivate** when the FACP Alarm Silenced LED is illuminated.

```

SYSTEM SETUP
1=CANADIAN OPT. OFF
2=WATERFLOW SIL. NO

```

System Setup Screen #3

3.6.5.7 Canadian Option

Pressing 1 while viewing System Setup Screen #3 will allow the programmer to configure the system to automatically monitor addressable ionization smoke detector sensitivity using Canadian specifications. The display will change to *Canadian Opt. On*. Each press of the 1 key will cause the display to toggle between *Canadian Opt. On* and *Canadian Opt. Off*:

```

SYSTEM SETUP
1=CANADIAN OPT. OFF
2=WATERFLOW SIL. NO

```

Relays Selection Screen

3.6.5.8 Waterflow Silenceable

Pressing 2 while viewing System Setup Screen #3 will allow the programmer to configure the system for silenceable on nonsilenceable waterflow circuits. Each press of the 2 key will toggle the display between *Waterflow Sil. No* and *Waterflow Sil. Yes*. When *Waterflow Sil. No* is selected, all output devices associated with a waterflow type input device, will be nonsilenceable. When *Waterflow Sil. Yes* is selected, all output devices associated with a waterflow type input device, will be silenceable.

3.6.6 Verify Loop

```

PROGRAMMING
1=LOOP SETUP
2=SYSTEM SETUP
3=VERIFY LOOP

```

Programming Screen #2

Pressing 3 while viewing Programming Screen #2, will select the Verify Loop option. During loop verification, the FACP polls each device on the SLC to determine if the device is communicating and whether or not it responds with the proper type identification. The following screen will be displayed while verification is in progress:

```

VERIFYING LOOPS
PLEASE WAIT

```

Verification Progress Screen

When Loop verification has been completed, the display will indicate that the system is OK or, if problems have been detected, any device type programming errors. Use the up and down arrow keys to view all detected errors.

3.6.7 History

```

PROGRAMMING
1=HISTORY
2=WALKTEST
3=OPTION MODULES
    
```

Programming Screen #3

The History option allows an authorized user to view or erase events which have occurred in the control panel. Pressing *1* while viewing Programming Screen #3 will display the History options as shown in the following display:

```

HISTORY
1=VIEW EVENTS
2=ERASE HISTORY
    
```

History Screen

```

HISTORY
1=VIEW EVENTS
2=ERASE HISTORY
    
```

History Screen

3.6.7.1 View Events

Pressing *1* while viewing the History Screen will allow the user to select the events to be viewed as illustrated in the following:

```

HISTORY
1=VIEW ALL
2=VIEW ALARMS
3=VIEW OTHER EVENTS
    
```

View Events Screen

While displaying the View Events screen, press *1* to view all events, *2* to view only alarms or *3* to view other events. Use the up and down arrow keys to scroll through all of the displayed events.

3.6.7.2 Erase History

The Erase History option allows a user to erase all events from the history file. This will provide a clean slate in order to use the history file to track future events. Pressing *2* while viewing the History Screen will display the following screen:

```

ERASE HISTORY
PROCEED ?
1=YES          2=NO
    
```

Erase History Screen

Pressing *1* while viewing the Erase History Screen will erase all events from the History file. During this process, the display will read as follows:

```

ERASING HISTORY
PLEASE WAIT
    
```

Erase History Wait Screen

After the History file has been erased, the display will return to the History Screen.

3.6.8 Walktest

```

PROGRAMMING
1=HISTORY
2=WALKTEST
3=OPTION MODULES

```

Programming Screen #3

Walktest allows an individual to test the fire alarm system without the necessity to reset the control panel after each device activation. Pressing 2 while viewing the Programming Screen #3 will cause the following Walktest options to be displayed:

```

WALKTEST
1=SILENT
2=AUDIBLE
3=VIEW RESULT

```

Walktest Screen

To perform a silent walktest which will not sound the NACs, press *1* while viewing the Walktest Screen. To perform an audible walktest, which will sound the NACs, press *2* while viewing the Walktest Screen. When either option is chosen, the panel will enter Walktest Mode and the following screen will be displayed::

```

UNIT IN WALKTEST
1=VIEW WALKTEST LOG
2=VIEW POINTS
3=VIEW SUMMARY

```

Unit In Walktest Screen

From this screen, it is possible to view the walktest log, untested system points or a summary of the addressable devices tested during the current walktest. The user can select between any of these screens without interrupting the current walktest session. The walktest session will not end until the Unit In Walktest screen is exited by pressing the Escape key.

Pressing *1* for *View Walktest Log* while viewing the Unit In Walktest screen will cause a screen similar to one of the following two screens to be displayed:

```

NO EVENTS IN
WALKTEST LOG

```

OR

```

ALARM: MONITOR
NORTH CLASSROOM
                                Z001
10*15A 012308 1M006

```

If there are no events in the current walktest session, the first screen will be displayed, indicating no events have been stored in the walktest log. If any events have been stored, a screen similar to the second will be displayed indicating the latest event. As walktest events occur, the display will change to indicate the latest event. All stored events can be scrolled on the screen by pressing the up or down arrow keys. To return to the first event, press the *1st Event* key.

Pressing 2 for *View Points* while viewing the Unit In Walktest screen will display one of the following screens:

NO POINTS IN
SYSTEM

OR

```
UNTESTED POINTS  010
1D001  SMOKE (PHOTO)
*****
NOT TESTED
```

If the system has no points installed, the first screen will be displayed. If points are installed, the second screen will be displayed, which allows the viewing of all untested system points and their status relating to the current walktest session. The up and down arrow keys will allow viewing of all untested points. If a point is tested while it is being displayed, the screen will update and display the next untested point. The first line indicates the total number of untested points. The second line displays information about an untested point. A description on the bottom of the screen will indicate if the displayed point has been disabled, if the Walktest option has been disabled for that point or if the point is not yet tested. The up and down arrow keys allow the user to scroll through all untested points.

Pressing 3 for *View Summary* while viewing the Unit In Walktest screen will display a new screen which will show a total of the tested detectors, tested modules, untested detectors and untested modules for the current walktest session.

The user can perform a one-person walktest by activating devices throughout the system. As each device is activated, the information about the activated device is stored in the Walktest Log. The information can be viewed by choosing one of the options from the Unit In Walktest screen.

To end the Walktest session, press the Escape key to return to the Walktest screen. Pressing 3 for *View Results* while viewing the Walktest screen, after a walktest session has been completed, will allow the operator to view the final results of the most recent walktest. The following screen will be displayed:

WALKTEST RESULTS

View Result Screen

Use the up and down arrow keys to view all of the walktest results which will be displayed. Note that the Walktest log is stored in RAM. If all power (AC and DC) is removed from the FACP, the Walktest log information will be lost. This information is also overwritten when subsequent walktests are performed.

3.6.9 Option Modules

```

PROGRAMMING
1=HISTORY
2=WALKTEST
3=OPTION MODULES

```

Programming Screen #3

Options available for the MS-9200UDLS include ACS Series, Graphic and LCD annunciators, printer connection for acquiring hardcopy printouts of panel data and PC (Personal Computer) connection for uploading and downloading panel data.

Pressing 3 while viewing Programming Screen #3 will display the following screen:

```

OPTION MODULES
1=ANNUNCIATORS
2=ONBOARD DACT
3=PRINTER/PC PR4800

```

Options Screen

Note that *PR4800* in the display indicates that a supervised printer, configured for 4800 baud, has been previously programmed into the system.

3.6.9.1 Annunciators

Pressing 1 while viewing the Options Screen will cause the control panel to display the following screens:

```

ANNUNCIATORS
1=TERM ENABLED NO
2=ACS OPTIONS
3=ANN-BUS OPTIONS

```

A Terminal Mode annunciator, ACS Mode annunciator or ANN-BUS annunciator/module can be installed in the MS-9200UDLS system. Do not use a mix of ACS annunciators and ANN annunciators since they use different communication protocols. ACS or ANN annunciators use the same TB9 terminal block connection. To install any of these devices, press the number corresponding to the desired device shown in the Annunciator Screen.

3.6.9.1.1 Term Options

While viewing the Annunciators screen, each press of the 1 key for *Term Enabled*, will cause the display to toggle between *Term Enabled No* and *Term Enabled Yes*.

Notes:

- *The LCD-80F is a Terminal Mode annunciator. To enable the MS-9200UDLS for LCD-80F operation, press 1 for *Term Enabled Yes*.
- The Terminal Mode annunciator (LCD-80F) and the Printer/PC use the same TB8 terminal block on the MS-9200UDLS main circuit board. Only one device can be connected at one time, therefore, enabling an annunciator in the Term Option will disable any Printer/PC communications.

ANNUNCIATORS 1=TERM ENABLED 2=ACS OPTIONS 3=ANN-BUS OPTIONS
--

3.6.9.1.2 ACS Options

Pressing *2* for *ACS Options* while viewing the Annunciators screen, will display the following screen:

ACS OPTIONS 1=ACS ENABLED NO 2=ACS INSTALLED
--

Pressing *1* while viewing the ACS Options screen will cause the display to toggle between *ACS Enabled Yes* and *ACS Enabled No*. To install an ACS annunciator, the display must read *ACS Enabled Yes*.

If ACS has been enabled, press *2* while viewing the Annunciator Screen to select addresses for the ACS annunciators. The following screen will be displayed:

ANNUNCIATOR ↓
1=ADDRESS 1 YES 2=ADDRESS 2 NO 3=ADDRESS 3 NO

ACS Installed Screen

Pressing the down arrow key will allow the programmer to view additional screens displaying Addresses 1 -31. Each screen will indicate if an address has been used for an installed ACS annunciator. To select one or more addresses for the installed ACS annunciator(s), press the number key corresponding to the address in each screen. The display for the selected address will change from *No* to *Yes*. Each press of the number key will cause the display to toggle between *No* and *Yes*. The address of each installed annunciator must be enabled to allow communication between the FACP and annunciator.

Annunciator addressing is specific to the MS-9200UDLS control panel. The following table describes the annunciator addresses and the corresponding addressable devices that will be annunciated at each annunciator address.

ACS Annunciator Address	Annunciator Displays the Following Points
1	8 General System Status Points & Zones 1 - 56
2	Zones 57 - 99 & 4 NACs
3	SLC Loop, Module Addresses 1 - 64
4	not used
5	SLC Loop, Module Addresses 65 - 99
6	not used
7	not used
8	SLC Loop, Detector Addresses 1 - 64
9	not used
10	SLC Loop, Detector Addresses 65 - 99
11	not used
12	not used
13	not used
14	not used
15	not used
16	not used
17	not used
18	not used
19	not used
20	8 General System Status Points & Zones 1 - 56
21	Zones 57 - 99 & 4 NACs
22	SLC Loop, Module Addresses 1 - 64
23	not used
24	SLC Loop, Module Addresses 65 - 99
25	not used
26	not used
27	SLC Loop, Detector Addresses 1 - 64
28	not used
29	SLC Loop, Detector Addresses 65 - 99
30	not used
31	not used
32	not used

The MS-9200UDLS must be programmed for the annunciators installed on the system. Refer to "Annunciators" on page 115 for information on annunciator programming. Make certain to program the annunciator addresses that have been physically installed on the system.

Note: The 8 General System Status Points include the following:

- General Alarm
- General Trouble
- General Supervisory
- Alarm Silenced
- System Off Normal
- AC Loss
- Battery Fault
- NAC Fault

3.6.9.1.3 ANN-BUS Options

Pressing 3 for *ANN-BUS Options*, while viewing the Annunciators screen, will cause the following screens to be displayed:



ANN-BUS Screen #1



ANN-BUS Screen #2

A printer module, graphic annunciator module, LCD annunciator module, LED annunciator module and relay module can be programmed into the MS-9200UDLS system. These devices communicate with the FACP over the ANN-BUS terminals on the control panel.

3.6.9.1.3.1 ANN-BUS Enabled

The ANN-BUS must be enabled if any modules are connected to the ANN-BUS terminals. To enable the ANN-BUS, press 1 while viewing ANN-BUS screen #1 so that the display reads *ANN-BUS Enabled Yes*. Each press of the 1 key will cause the display to toggle between *ANN-BUS Enabled Yes* and *ANN-BUS Enabled No*.

3.6.9.1.3.2 Modules Installed

If an ANN-BUS module is installed, press 2 for *Modules Installed* while viewing ANN-BUS screen #1 to select ANN-BUS addresses for the module(s). The following screen will be displayed.

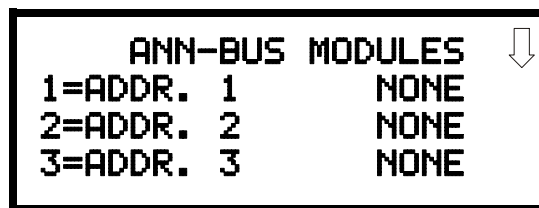

ANN-BUS Modules Screen #1

Pressing the down arrow key will allow the programmer to view additional screens displaying Addresses 1-8. To select one or more addresses for the installed module(s), press the number key corresponding to the module address in each screen. The following screen will be displayed for each address:

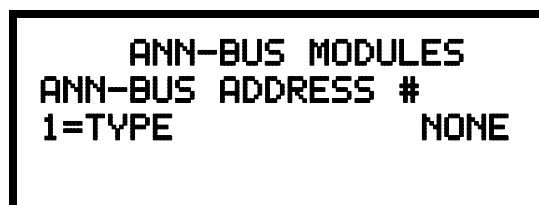

ANN-BUS Address Screen

Pressing *1* for *Type* will display the following screens:

```

ANN-BUS MODULE TYPE ↓
1=NOT INSTALLED
2=ANN-80 MODULE
3=ANN-I/O MODULE
  
```

Module Type Screen #1

```

ANN-BUS MODULE TYPE ↑↓
1=ANN-S/PG MODULE
2=ANN-LED MODULE
3=ANN-RLY MODULE
  
```

Module Type Screen #2

```

ANN-BUS MODULE TYPE ↑
1=ANN-AUDIO
  
```

Module Type Screen #3

Press the number corresponding to the module/device type that is installed with the selected address.

Note: If the module type selected is the *ANN-80*, *ANN-S/PG* or *ANN-AUDIO* or if *Not Installed* is selected, the ANN-BUS Address Screen shown on the previous page will be displayed following the module selection. The options selected for each of these modules will be the same for all modules of the same type (refer to "ANN-S/PG (Print) Options" on page 129 and "ANN-80 Options" on page 130).

If ANN-I/O, ANN-LED or ANN-RLY is the selected module type, the following ANN-BUS Address Screen will be displayed:

```

ANN-BUS MODULES
ANN-BUS ADDRESS #
1=TYPE ANN-I/O
2=MODULE OPTIONS
  
```

ANN-BUS Address Screen

Since the options for each of these module types can be individually set, pressing *2* for *Module Options*, while viewing the ANN-BUS Address Screen will display the available options as described below.

ANN-I/O Options

Pressing 2 for Module Options while viewing ANN-BUS Address screen when the ANN-I/O option is selected will display the following screen:

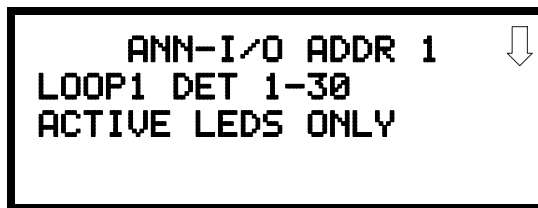

ANN-I/O Address Screen #1

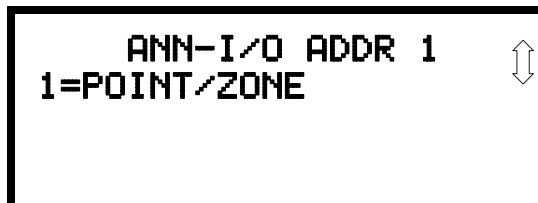

ANN-I/O Address Screen #2

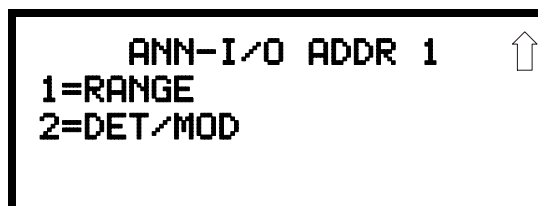

ANN-I/O Address Screen #3

The first screen indicates that the ANN-I/O at ANN-BUS address 1 is programmed to annunciate SLC Loop #1 addressable Detectors with addresses 1 through 30. The programming can be changed using ANN-I/O Address Screens 2 and 3.

Pressing 1 while viewing ANN-I/O Address Screen #2 will program the annunciator module to annunciate either Point (addressable device address) information or Zone information.

Pressing 1 while viewing ANN-I/O Address Screen #3 will select the Point or Zone range to be annunciated (refer to the tables in "ANN-I/O Zone Option" on page 121 and "ANN-I/O Point Option" on page 122).

Pressing 2 while viewing ANN-I/O Address Screen #3 will select either addressable detectors or addressable modules to be annunciated.

ANN-I/O Zone Option

If *Zone* is selected as the module option, the first ten LEDs on the first ANN-I/O module will display the system status information. The remaining 30 LEDs on the first module and 40 LEDs on the remaining modules will display the active/alarm status of each zone in the Zone Range programmed for that particular module. The LED assignments for each ANN-I/O module will be as follows.

Module LED	Zone Range 0-29	Zone Range 30-69	Zone Range 70-99
1	AC Fault	Zone 30	Zone 70
2	Fire Alarm	Zone 31	Zone 71
3	Supervisory	Zone 32	Zone 72
4	Trouble	Zone 33	Zone 73
5	Alarm Silenced	Zone 34	Zone 74
6	Earth Fault	Zone 35	Zone 75
7	Battery Fault	Zone 36	Zone 76
8	Charger Fault	Zone 37	Zone 77
9	NAC Fault	Zone 38	Zone 78
10	Disabled	Zone 39	Zone 79
11	Zone 00	Zone 40	Zone 80
12	Zone 01	Zone 41	Zone 81
13	Zone 02	Zone 42	Zone 82
14	Zone 03	Zone 43	Zone 83
15	Zone 04	Zone 44	Zone 84
16	Zone 05	Zone 45	Zone 85
17	Zone 06	Zone 46	Zone 86
18	Zone 07	Zone 47	Zone 87
19	Zone 08	Zone 48	Zone 88
20	Zone 09	Zone 49	Zone 89
21	Zone 10	Zone 50	Zone 90
22	Zone 11	Zone 51	Zone 91
23	Zone 12	Zone 52	Zone 92
24	Zone 13	Zone 53	Zone 93
25	Zone 14	Zone 54	Zone 94
26	Zone 15	Zone 55	Zone 95
27	Zone 16	Zone 56	Zone 96
28	Zone 17	Zone 57	Zone 97
29	Zone 18	Zone 58	Zone 98
30	Zone 19	Zone 59	Zone 99
31	Zone 20	Zone 60	Not Used
32	Zone 21	Zone 61	Not Used
33	Zone 22	Zone 62	Not Used
34	Zone 23	Zone 63	Not Used
35	Zone 24	Zone 64	Not Used
36	Zone 25	Zone 65	Not Used
37	Zone 26	Zone 66	Not Used
38	Zone 27	Zone 67	Not Used
39	Zone 28	Zone 68	Not Used
40	Zone 29	Zone 69	Not Used

ANN-I/O Point Option

If *Point* is selected as the module option, the first ten LEDs on the first ANN-I/O module will display the system status information. The remaining 30 LEDs on the first module and 40 LEDs on each additional module will display the active/alarm status of each point in the Point Range programmed for that particular module. The points that will be annunciated on a particular ANN-I/O module depend on the programming options selected as far as the device type (detector or module) to be annunciated. The LED assignments for each ANN-I/O module will be as follows.

Module LED	Point Range 1-30	Point Range 31-70	Point Range 71-99
1	AC Fault	Point 31	Point 71
2	Fire Alarm	Point 32	Point 72
3	Supervisory	Point 33	Point 73
4	Trouble	Point 34	Point 74
5	Alarm Silenced	Point 35	Point 75
6	Earth Fault	Point 36	Point 76
7	Battery Fault	Point 37	Point 77
8	Charger Fault	Point 38	Point 78
9	NAC Fault	Point 39	Point 79
10	Disabled	Point 40	Point 80
11	Point 01	Point 41	Point 81
12	Point 02	Point 42	Point 82
13	Point 03	Point 43	Point 83
14	Point 04	Point 44	Point 84
15	Point 05	Point 45	Point 85
16	Point 06	Point 46	Point 86
17	Point 07	Point 47	Point 87
18	Point 08	Point 48	Point 88
19	Point 09	Point 49	Point 89
20	Point 10	Point 50	Point 90
21	Point 11	Point 51	Point 91
22	Point 12	Point 52	Point 92
23	Point 13	Point 53	Point 93
24	Point 14	Point 54	Point 94
25	Point 15	Point 55	Point 95
26	Point 16	Point 56	Point 96
27	Point 17	Point 57	Point 97
28	Point 18	Point 58	Point 98
29	Point 19	Point 59	Point 99
30	Point 20	Point 60	Not Used
31	Point 21	Point 61	Not Used
32	Point 22	Point 62	Not Used
33	Point 23	Point 63	Not Used
34	Point 24	Point 64	Not Used
35	Point 25	Point 65	Not Used
36	Point 26	Point 66	Not Used
37	Point 27	Point 67	Not Used
38	Point 28	Point 68	Not Used
39	Point 29	Point 69	Not Used
40	Point 30	Point 70	Not Used

PROGRAMMING
1=ANN-RLY OPTIONS
2=ANN-LED OPTIONS

ANN-BUS Screen #3

ANN-LED Options

Pressing 2 for Module Options while viewing ANN-BUS Address Screen when the ANN-LED option is selected, will display the following screen:

```

ANN-LED ADDR #
LOOP1 DET 1-10
ALARM, SUPERV, TBL
  
```

ANN-LED Address Screen #1

```

ANN-LED ADDR #
1=POINT/ZONE
2=ALARM/ATS
  
```

ANN-LED Address Screen #2

```

ANN-LED ADDR #
1=RANGE
2=DET/MOD
3=LOOP#
  
```

ANN-LED Address Screen #3

The first screen indicates that the ANN-LED at the selected ANN-BUS address is programmed to annunciate Alarms, Supervisories and Troubles for SLC Loop #1 addressable Detectors with addresses 1 through 10. The programming can be changed using ANN-LED Address Screens 2 and 3.

Pressing 1 while viewing ANN-LED Address Screen #2 will program the annunciator module to annunciate either Point (addressable device address) information or Zone information.

Pressing 2 while viewing ANN-LED Address Screen #2 will program the annunciator module to annunciate only Alarms for addressable device addresses 1-30 or Alarms, Supervisories and Troubles for addressable device addresses 1-10.

Pressing 1 while viewing ANN-LED Address Screen #3 will select the Point or Zone range to be annunciated - refer to the tables in "ANN-LED Zone Option - Alarm Only (for use with ANN-RLED module)" on page 124 and "ANN-LED Point Option - Alarm Only (for use with ANN-RLED module)" on page 126.

Pressing 2 while viewing ANN-LED Address Screen #3 will select either addressable detectors or addressable modules to be annunciated.

ANN-LED Zone Option - Alarm Only (for use with ANN-RLED module)

If *Zone* is selected as the module option, and the module is programmed to annunciate **alarms only**, the first ten LEDs on the first ANN-LED module will display the system status information. The remaining 30 LEDs on the first module and the last 30 LEDs on the remaining modules will display the active/alarm status of each zone in the Zone Range programmed for that particular module. The LED assignments for each ANN-LED module will be as follows.

ANN-RLED Module #1

Alarm Silenced	NAC 1 Fault	NAC 2 Fault	NAC 3 Fault	NAC 4 Fault
Earth Fault	Battery Fault	Charger Fault	Disabled	Maintenance
Zone 00 Active/Alarm	Zone 01 Active/Alarm	Zone 02 Active/Alarm	Zone 03 Active/Alarm	Zone 04 Active/Alarm
Zone 05 Active/Alarm	Zone 06 Active/Alarm	Zone 07 Active/Alarm	Zone 08 Active/Alarm	Zone 09 Active/Alarm
Zone 10 Active/Alarm	Zone 11 Active/Alarm	Zone 12 Active/Alarm	Zone 13 Active/Alarm	Zone 14 Active/Alarm
Zone 15 Active/Alarm	Zone 16 Active/Alarm	Zone 17 Active/Alarm	Zone 18 Active Alarm	Zone 19 Active/Alarm
Zone 20 Active/Alarm	Zone 21 Active/Alarm	Zone 22 Active/Alarm	Zone 23 Active/Alarm	Zone 24 Active/Alarm
Zone 25 Active/Alarm	Zone 26 Active/Alarm	Zone 27 Active/Alarm	Zone 28 Active/Alarm	Zone 29 Active/Alarm

ANN-RLED Module #2

Not Used	Not Used	Not Used	Not Used	Not Used
Not Used	Not Used	Not Used	Not Used	Not Used
Zone 30 Active/Alarm	Zone 31 Active/Alarm	Zone 32 Active/Alarm	Zone 33 Active/Alarm	Zone 34 Active/Alarm
Zone 35 Active/Alarm	Zone 36 Active/Alarm	Zone 37 Active/Alarm	Zone 38 Active/Alarm	Zone 39 Active/Alarm
Zone 40 Active/Alarm	Zone 41 Active/Alarm	Zone 42 Active/Alarm	Zone 43 Active/Alarm	Zone 44 Active/Alarm
Zone 45 Active/Alarm	Zone 46 Active/Alarm	Zone 47 Active/Alarm	Zone 48 Active Alarm	Zone 49 Active/Alarm
Zone 50 Active/Alarm	Zone 51 Active/Alarm	Zone 52 Active/Alarm	Zone 53 Active/Alarm	Zone 54 Active/Alarm
Zone 55 Active/Alarm	Zone 56 Active/Alarm	Zone 57 Active/Alarm	Zone 58 Active/Alarm	Zone 59 Active/Alarm

The LED assignments for the modules annunciating Zone Ranges 60 - 89 and 90 - 99, will follow the same pattern as the second ANN-RLED module.

ANN-LED Zone Option - Alarm, Trouble and Supervisory

If *Zone* is selected as the module option, and the module is programmed to annunciate **alarms, troubles and supervisories**, the first ten LEDs on the first ANN-LED module will display the system status information. The remaining 30 LEDs on the first module and the last 30 LEDs on the remaining modules will display the alarm, trouble and supervisory status for each of the ten zones in the Zone Range programmed for that particular module. The LED assignments for each ANN-LED module will be as follows.

ANN-LED Module #1

Alarm Silenced	NAC 1 Fault	NAC 2 Fault	NAC 3 Fault	NAC 4 Fault
Earth Fault	Battery Fault	Charger Fault	Disabled	Maintenance
Zone 00 Active/Alarm	Zone 01 Active/Alarm	Zone 02 Active/Alarm	Zone 03 Active/Alarm	Zone 04 Active/Alarm
Zone 00 Trouble	Zone 01 Trouble	Zone 02 Trouble	Zone 03 Trouble	Zone 04 Trouble
Zone 00 Supervisory	Zone 01 Supervisory	Zone 02 Supervisory	Zone 13 Supervisory	Zone 04 Supervisory
Zone 05 Active/Alarm	Zone 06 Active/Alarm	Zone 07 Active/Alarm	Zone 08 Active Alarm	Zone 09 Active/Alarm
Zone 05 Trouble	Zone 06 Trouble	Zone 07 Trouble	Zone 08 Trouble	Zone 09 Trouble
Zone 05 Supervisory	Zone 06 Supervisory	Zone 07 Supervisory	Zone 08 Supervisory	Zone 09 Supervisory

ANN-LED Module #2

Not Used	Not Used	Not Used	Not Used	Not Used
Not Used	Not Used	Not Used	Not Used	Not Used
Zone 10 Active/Alarm	Zone 11 Active/Alarm	Zone 12 Active/Alarm	Zone 13 Active/Alarm	Zone 14 Active/Alarm
Zone 10 Trouble	Zone 11 Trouble	Zone 12 Trouble	Zone 13 Trouble	Zone 14 Trouble
Zone 10 Supervisory	Zone 11 Supervisory	Zone 12 Supervisory	Zone 13 Supervisory	Zone 14 Supervisory
Zone 15 Active/Alarm	Zone 16 Active/Alarm	Zone 17 Active/Alarm	Zone 18 Active/Alarm	Zone 19 Active/Alarm
Zone 15 Trouble	Zone 16 Trouble	Zone 17 Trouble	Zone 18 Trouble	Zone 19 Trouble
Zone 15 Supervisory	Zone 16 Supervisory	Zone 17 Supervisory	Zone 18 Supervisory	Zone 19 Supervisory

The LED assignments for the modules annunciating Zone Ranges 20 - 29, 30 - 39, 40 - 49, 50 - 59, 60 - 69, 70 - 79, 80 - 89 and 90 - 99, will follow the same pattern as the second ANN-LED module.

ANN-LED Point Option - Alarm Only (for use with ANN-RLED module)

If *Point* is selected as the module option and the module is programmed to annunciate **alarms** only, the first ten LEDs on the first ANN-LED module will display the system status information. The remaining 30 LEDs on the first module and the last 30 LEDs on each additional module will display the active/alarm status of each point in the Point Range programmed for that particular module. The points that will be annunciated on a particular ANN-LED module depend on the programming options selected as far as which SLC loop and the device type (detector or module) to be annunciated. The LED assignments for each ANN-LED module will be as follows.

ANN-RLED Module #1 (Point Range 01 - 30)

Alarm Silenced	NAC 1 Fault	NAC 2 Fault	NAC 3 Fault	NAC 4 Fault
Earth Fault	Battery Fault	Charger Fault	Disabled	Maintenance
Point 01 Active/Alarm	Point 02 Active/Alarm	Point 03 Active/Alarm	Point 04 Active/Alarm	Point 05 Active/Alarm
Point 06 Active/Alarm	Point 07 Active/Alarm	Point 08 Active/Alarm	Point 09 Active/Alarm	Point 10 Active/Alarm
Point 11 Active/Alarm	Point 12 Active/Alarm	Point 13 Active/Alarm	Point 14 Active/Alarm	Point 15 Active/Alarm
Point 16 Active/Alarm	Point 17 Active/Alarm	Point 18 Active/Alarm	Point 19 Active/Alarm	Point 20 Active/Alarm
Point 21 Active/Alarm	Point 22 Active/Alarm	Point 23 Active/Alarm	Point 24 Active/Alarm	Point 25 Active/Alarm
Point 26 Active/Alarm	Point 27 Active/Alarm	Point 28 Active/Alarm	Point 29 Active/Alarm	Point 30 Active/Alarm

ANN-RLED Module #2 (Point Range 31 - 60)

Not Used	Not Used	Not Used	Not Used	Not Used
Not Used	Not Used	Not Used	Not Used	Not Used
Point 31 Active/Alarm	Point 32 Active/Alarm	Point 33 Active/Alarm	Point 34 Active/Alarm	Point 35 Active/Alarm
Point 36 Active/Alarm	Point 37 Active/Alarm	Point 38 Active/Alarm	Point 39 Active/Alarm	Point 40 Active/Alarm
Point 41 Active/Alarm	Point 42 Active/Alarm	Point 43 Active/Alarm	Point 44 Active/Alarm	Point 45 Active/Alarm
Point 46 Active/Alarm	Point 47 Active/Alarm	Point 48 Active/Alarm	Point 49 Active/Alarm	Point 50 Active/Alarm
Point 51 Active/Alarm	Point 52 Active/Alarm	Point 53 Active/Alarm	Point 64 Active/Alarm	Point 55 Active/Alarm
Point 56 Active/Alarm	Point 57 Active/Alarm	Point 58 Active/Alarm	Point 59 Active/Alarm	Point 60 Active/Alarm

The LED assignments for the modules annunciating Point Ranges 61 - 90 and 91 - 99, will follow the same pattern as the second ANN-RLED module.

ANN-LED Point Option - Alarm, Trouble and Supervisory

If *Point* is selected as the module option, and the module is programmed to annunciate **alarms, troubles and supervisories**, the first ten LEDs on the first ANN-LED module will display the system status information. The remaining 30 LEDs on the first module and the last 30 LEDs on the remaining modules will display the alarm, trouble and supervisory status for each of the ten zones in the Point Range programmed for that particular module. The LED assignments for each ANN-LED module will be as follows.

ANN-LED Module #1 (Point Range 01 - 10)

Alarm Silenced	NAC 1 Fault	NAC 2 Fault	NAC 3 Fault	NAC 4 Fault
Earth Fault	Battery Fault	Charger Fault	Disabled	Maintenance
Point 01 Active/Alarm	Point 02 Active/Alarm	Point 03 Active/Alarm	Point 04 Active/Alarm	Point 05 Active/Alarm
Point 01 Trouble	Point 02 Trouble	Point 03 Trouble	Point 04 Trouble	Point 05 Trouble
Point 01 Supervisory	Point 02 Supervisory	Point 03 Supervisory	Point 04 Supervisory	Point 05 Supervisory
Point 06 Active/Alarm	Point 07 Active/Alarm	Point 08 Active/Alarm	Point 09 Active/Alarm	Point 10 Active/Alarm
Point 06 Trouble	Point 07 Trouble	Point 08 Trouble	Point 09 Trouble	Point 10 Trouble
Point 06 Supervisory	Point 07 Supervisory	Point 08 Supervisory	Point 09 Supervisory	Point 10 Supervisory

ANN-LED Module #2 (Point Range 11 - 20)

Not Used	Not Used	Not Used	Not Used	Not Used
Not Used	Not Used	Not Used	Not Used	Not Used
Point 11 Active/Alarm	Point 12 Active/Alarm	Point 13 Active/Alarm	Point 14 Active/Alarm	Point 15 Active/Alarm
Point 11 Trouble	Point 12 Trouble	Point 13 Trouble	Point 14 Trouble	Point 15 Trouble
Point 11 Supervisory	Point 12 Supervisory	Point 13 Supervisory	Point 14 Supervisory	Point 15 Supervisory
Point 16 Active/Alarm	Point 17 Active/Alarm	Point 18 Active/Alarm	Point 19 Active/Alarm	Point 20 Active/Alarm
Point 16 Trouble	Point 17 Trouble	Point 18 Trouble	Point 19 Trouble	Point 20 Trouble
Point 16 Supervisory	Point 17 Supervisory	Point 18 Supervisory	Point 19 Supervisory	Point 20 Supervisory

The LED assignments for the modules annunciating Point Ranges 21 - 30, 31 - 40 and 41 - 50, 51 - 60, 61 - 70, 71 - 80, 81 - 90 and 91 - 99, will follow the same pattern as the second ANN-LED Module.

ANN-RLY Options

Pressing 2 for *Module Options* while viewing ANN-BUS Address Screen when the ANN-RLY option is selected, will cause the following screen to be displayed:

ANN-RLY	ADDR. #	
1=RELAY 1	ZONE 00	↓
2=RELAY 2	ZONE 01	
3=RELAY 3	ZONE 02	

ANN-RLY Options Screen

The ANN-RLY module provides ten Form-C relays which can be programmed for various functions. The initial screen displays Relays 1 through 3. Pressing the down arrow key will display the remaining relays for this module.

To program any of the ANN-RLY relays, while viewing the appropriate ANN-RLY Option screen, press the number key corresponding to the relay to be programmed. Following is a list of the available programming options for each relay:

- Alarm
- Supervisory
- Supervisory AR
- Trouble
- Comm Fail
- Process Mon
- Process Mon AR
- AC Loss
- Hazard
- Medical
- Silenceable Alarm
- Zone Active XX

3.6.9.1.3.3 Auto-Configure

The ANN-BUS Auto-Configure features allows the programmer to quickly bring all installed ANN-BUS modules online. The software will search for all ANN-BUS modules and automatically program the device type and address into the system. For the Auto-Configure to work, the ANN-BUS must be enabled, the annunciators must be connected/powered and a unique address must be set on each annunciator. Pressing 3 while viewing ANN-BUS Screen #1 will begin the Auto-Configure process and cause the following screen to be displayed:

ANN-BUS AUTO-CONGFIGURE IN PROGRESS PLEASE WAIT

Auto-Configure Screen

```

ANN-BUS
1=ANN-S/PG OPTIONS
2=ANN-80 OPTIONS

```

ANN-BUS Screen #2

3.6.9.1.3.4 ANN-S/PG (Print) Options

The Print option allows the programmer to configure the optional printer. Pressing 1 while viewing ANN-BUS screen #2 will display the following screens:

```

ANN-S/PG OPTIONS
1=PORT                PAR
2=PRINTER SUPV       NO
3=OFFLINE TIMER      60

```

ANN-S/PG Options Screen #1

```

ANN-S/PG OPTIONS
1=BAUD RATE          N/A
2=DATA BITS          N/A
3=PARITY              N/A

```

ANN-S/PG Options Screen #2

```

ANN-S/PG OPTIONS
1=STOP BITS          N/A

```

ANN-S/PG Options Screen #3

Pressing *1* for Port while viewing ANN-S/PG Options screen #1 will allow the programmer to select between a Parallel and Serial Port for printer connection. Each press of the *1* key will cause the display to toggle between *Port PAR* (parallel) and *Port SER* (serial). It is important to note that the interface selected determines which options are available to the user.

If the Parallel Port option is selected, the user has the option to supervise the printer and select an offline timer for the supervision by pressing 2 for Printer Supervision while viewing Print Options screen #1. Each press of the 2 key will cause the display to toggle between *Printer Supv NO* for no supervision and *Printer Supv YES* for printer supervision. Note that this option is not selectable if the Serial Port option has been selected.

If the Parallel Port option is selected, the user has the ability to select an *Offline Timer* by pressing 3 while viewing Print Options screen #1. The resultant screen allows the programmer to program the *Offline Timer* for a delay of between 0 and 255 seconds before loss of printer supervision is reported as a trouble.

If the Serial Port option is selected, the *Printer Supv* and *Offline Timer* options will not be available. The Baud Rate, Data Bits, Parity and Stop Bits options are only available when the Serial Port option has been selected.

Pressing *1* for *Baud Rate* while viewing ANN-S/PG Options screen #2 will cause a screen to appear which allow the user to select a Baud Rate of *19200*, *9600* or *2400*.

Pressing 2 for *Data Bits* while viewing ANN-S/PG Options screen #2 will cause a screen to appear which allows the user to select 7 or 8 *Data Bits*.

Pressing *3* for *Parity* while viewing ANN-S/PG Options screen #2 will cause a screen to appear which allows the user to select between *No Parity*, *Even Parity* or *Odd Parity*.

Pressing *1* for *Stop Bits* while viewing ANN-S/PG Options screen #3 will cause a screen to appear which allows the user to select between *1.0* or *2.0 Stop Bits*.

3.6.9.1.3.5 ANN-80 Options

Pressing *2* while viewing ANN-BUS screen #2 will display the following screen:

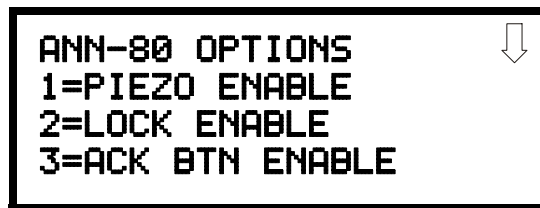

ANN-80 Options Screen #1

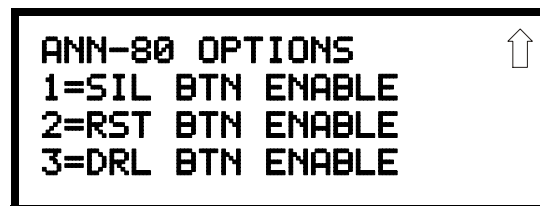

ANN-80 Options Screen #2

The *Piezo Enable* option allows the programmer to select whether the piezo sounder on any installed ANN-80 module will ever sound. Pressing *1* while viewing the ANN-80 Options Screen #1 causes the display to toggle between *Piezo Enable Yes* and *Piezo Enable No*.

The *Lock Enable* option allows the programmer to select whether or not any installed ANN-80 annunciator must be unlocked by its key before any annunciator key presses will function. Pressing *2* while viewing the ANN-80 Options Screen #1 causes the display to toggle between *Lock Enable Yes* (annunciator must be unlocked for keys to function) and *Lock Enable No* (lock position is ignored).

The Acknowledge Button Enable (*ACK BTN ENABLE*) option allows the programmer to select whether the Ack/Step button on any installed ANN-80 annunciator will function normally or always be ignored. Pressing *3* while viewing the ANN-80 Options Screen #1 causes the display to toggle between *Ack Btn Enable Yes* (Ack/Step button functions normally) and *Ack Btn Enable No* (Ack/Step button never functions).

The Silence Button Enable (*SIL BTN ENABLE*) option allows the programmer to select whether the Silence button on any installed ANN-80 annunciator will function normally or always be ignored. Pressing *1* while viewing the ANN-80 Options Screen #2 causes the display to toggle between *Sil Btn Enable Yes* (Silence button functions normally) and *Sil Btn Enable No* (Silence button never functions).

The Reset Button Enable (*RST BTN ENABLE*) option allows the programmer to select whether the Reset button on any installed ANN-80 annunciator will function normally or always be ignored. Pressing *2* while viewing the ANN-80 Options Screen #2 causes the display to toggle between *Rst Btn Enable Yes* (Reset button functions normally) and *Rst Btn Enable No* (Reset button never functions).

The Drill Button Enable (*DRL BTN ENABLE*) option allows the programmer to select whether the Drill button on any installed ANN-80 annunciator will function normally or always be ignored. Pressing 3 while viewing the ANN-80 Options Screen #2 causes the display to toggle between *Drl Btn Enable Yes* (Drill button functions normally) and *Drl Btn Enable No* (Drill button never functions).

OPTION MODULES
1=ANNUNCIATORS
2=ON BOARD DACT
3=PRINTER/PC

Option Module Screen

3.6.9.2 Onboard DACT

The Onboard DACT (Digital Alarm Communicator/Transmitter) provides communication to a central station. Pressing 2 while viewing the Option Module Screen will cause the following screens to be displayed:

```

ON BOARD DACT
1=ENABLED          YES
2=PRIMARY PHONE
3=SECONDARY PHONE
  
```

On Board DACT Screen #1

```

ON BOARD DACT
1=SERVICE TERMINAL
2=CENTRAL STATION
3=SUPERV PHONE LINE
  
```

On Board DACT Screen #2

3.6.9.2.1 Onboard DACT Enable

To enable the onboard DACT, press 1 while viewing Onboard DACT Screen #1 until the display reads *Enabled Yes*. The display will toggle between *Enabled Yes* and *Enabled No* with each press of the key.

3.6.9.2.2 Primary Phone

Press 2 while viewing On Board DACT Screen #1 to program the type of primary phone line being connected to the DACT. The following screen will be displayed:

```

ON BOARD DACT
PRIMARY PHONE LINE
1=TYPE          TOUCHTONE
  
```

Primary Phone Line Screen

To select the type, press 1 while viewing the Primary Phone Line screen. The following screen will be displayed:

```

PHONE LINE
1=TOUCHTONE
2=ROTARY 67/33
3=ROTARY 62/38
  
```

Primary Phone Type Screen

Press 1 to select Touchtone dialing, 2 to select Rotary dialing with a make/break ratio of 67/33 or 3 to select Rotary dialing with a make/break ratio of 62/38.

```
ON BOARD DACT
1=ENABLED
2=PRIMARY PHONE
3=SECONDARY PHONE
```

On Board DACT Screen #1

3.6.9.2.3 Secondary Phone

Press 3 while viewing On Board DACT Screen #1 to program the type of secondary phone line being connected to the DACT. The following screen will be displayed:

```
ON BOARD DACT
SECONDARY PHONE LINE
1=TYPE          TOUCHTONE
```

Secondary Phone Line Screen

To select the type, press 1 while viewing the Secondary Phone Line screen. The following screen will be displayed:

```
PHONE LINE
1=TOUCHTONE
2=ROTARY 67/33
3=ROTARY 62/38
```

Secondary Phone Type Screen

Press 1 to select Touchtone dialing, 2 to select Rotary dialing with a make/break ratio of 67/33 or 3 to select Rotary dialing with a make/break ratio of 62/38.

```
ON BOARD DACT
1=SERVICE TERMINAL
2=CENTRAL STATION
3=SUPERV PHONE LINE
```

On Board DACT Screen #2

3.6.9.2.4 Service Terminal

The FACP can be programmed remotely from a PC using a modem and telephone line. Information can also be retrieved from the FACP using the same method. The Upload/Download option allows an operator to set the necessary parameters to allow the uploading and downloading of data between the FACP and PC. The Service Terminal selection provides the means for entering these parameters.

Pressing 1 while viewing On Board DACT Screen #2 will cause the following screen to appear:

```
SERVICE TERMINAL
1=RING COUNT    0
```

Service Terminal Screen

```

SERVICE TERMINAL
1=RING COUNT

```

Service Terminal Screen #2

3.6.9.2.4.1 Ring Count

The ring count designates the number of rings allowed on the phone line prior to answering an incoming call from a service terminal. The factory default is 0 which means the control panel will not answer an incoming call. This entry may be programmed for 1 to 25 rings.

To change the Ring Count, press 1 while viewing the Service Terminal Screen #2. The following screen will be displayed:

```

RING COUNT
RANGE 0-25 RANGE

```

Ring Count Screen

A flashing cursor will appear in the lower left corner of the display. Enter the two-digit ring count which can be a value between 00 and 25. After the second digit is entered, the display will return to the Service Terminal screen.

```

ON BOARD DACT
1=SERVICE TERMINAL
2=CENTRAL STATION
3=SUPERV PHONE LINE

```

On Board DACT Screen #2

3.6.9.2.5 Central Station

Central Station programming configures the control panel DACT for contacting the central station. Pressing 2 while viewing On Board DACT Screen #2 will cause the following screens to be displayed:

```

CENTRAL STATION
1=REPORTING DISABLED
2=REPORT          BACKUP
3=CALL LIMIT

```

Central Station Screen #1

```

CENTRAL STATION
1=PRIMARY
2=SECONDARY
3=REPORT STYLE

```

Central Station Screen #2

3.6.9.2.5.1 Reporting Enable

To enable the DACT for reporting FACP activity to the central station, press 1 while viewing Central Station Screen #1 so the display reads *Reporting Enabled*. Each press of the 1 key will toggle the display between *Reporting Disabled* and *Reporting Enabled*.

3.6.9.2.5.2 Backup Reporting

The DACT can be programmed to transmit reports to primary and/or secondary central station phone numbers as a backup. Press 2 while viewing Central Station Screen #1 to display the following screen:

```
BACKUP REPORTING
1=BACKUP ONLY
2=FIRST AVAILABLE
```

Backup Reporting Screen

Press 1 to have all reports transmitted to the central station secondary phone number as a backup only if the primary phone line fails. Press 2 to send reports to the first available phone number.

3.6.9.2.6 Trouble Call Limit (Dialer Runaway Prevention)

The Call Limit option limits the number of DACT trouble calls to the Central Station, to a programmed amount between 0 and 99, for each unique trouble within a 24 hour period. Separate limit counters keep track of each unique type of trouble. Note that the number of phone line (communication) faults called to the Central Station are not limited by this feature. No subsequent restoral message is sent to the Central Station(s) for a particular trouble whose call limit has been reached. Local DACT annunciation will still track the particular trouble and restoral.

To set the Trouble Call Limit, press 3 while viewing Central Station Screen #1. The following screen will be displayed.

```
TRouble CALL LIMIT
00-99 RANGE
*
```

Backup Reporting Screen

Enter a value between 00 and 99, then press Enter to set the Call Limit to this value.

Note: Entering a value of 00 will disable the Trouble Call Limit allowing the DACT to call the Central Station an unlimited number of times.

CENTRAL STATION
1=PRIMARY
2=SECONDARY
3=REPORT STYLE

Central Station Screen #2

3.6.9.2.6.1 Central Station Primary and Secondary Phone Numbers

Pressing 1 for Primary or 2 for Secondary will display the following screens.

Note that the following information must be entered for both the Primary and Secondary Central Station Phone Numbers.

CENTRAL STATION # 
1=TEST TIME INT 24
2=ACCOUNT CODE 0000
3=24HR TST TIME 0021

Primary/Secondary Screen #1

CENTRAL STATION 
1=PHONE NUMBER

Primary/Secondary Screen #2

CENTRAL STATION 
1=COMM FORMAT
ADEMCO-CONTACT-ID

Primary/Secondary Screen #3

CENTRAL STATION 
1=EVENT CODES

Primary/Secondary Screen #4

```
CENTRAL STATION
1=TEST TIME INT
2=ACCOUNT CODE
3=24HR TST TIME
```

Primary/Secondary Screen #1

Test Time Interval

Pressing 1 while viewing Primary/Secondary Screen #1 will cause the following screens to be displayed:

```
TEST TIME INTERVAL ↓
1=24 HOURS
2=12 HOURS
3=8 HOURS
```

Test Time Interval Screen #1

```
TEST TIME INTERVAL ↑
1=6 HOURS
```

Test Time Interval Screen #2

The test report sent to the Central Station phone number may be sent once every 6, 8, 12 or 24 hours. Select the desired Test Time Interval by pressing the corresponding digit in the screens shown above.

Account Code

Pressing 2 while viewing Primary/Secondary Screen #1 will cause the following screen to be displayed:

```
ACCOUNT CODE
4 CHAR RANGE 0-F
█
```

Account Codes Screen

The Account Code, which is assigned by a Central Station, depends on the communication format being used. The Account Code screen will have a flashing cursor in the lower left corner. Enter the supplied account code using 0 - 9 and A- F keys.

```

CENTRAL STATION
1=TEST TIME INT
2=ACCOUNT CODE
3=24HR TST TIME

```

Primary/Secondary Screen #1

24 Hour Test Time

Pressing 3 while viewing Primary/Secondary Screen #1 will cause the following screen to be displayed:

```

24 HOUR TEST TIME
RANGE 0000-2359

```

24 Hour Test Time Screen

Use the 24 Hour Test Time screen to program the time that the DACT will transmit the 24 Hour Test to the Central Station. A flashing cursor will appear in the lower left corner of the screen. Enter a four digit number representing the test time using military time (0000 = midnight and 2359 = 11:59PM).

```

CENTRAL STATION
1=PHONE NUMBER

```

Primary/Secondary Screen #2

Phone Number

Pressing 1 while viewing Primary/Secondary Screen #2 will cause the following screen to be displayed:

```

PHONE NUMBER
20 NUMBERS MAXIMUM

```

Phone Number Screen

The Phone Number screen is used to enter the Central Station phone number that the DACT will be contacting. A maximum of 20 characters can be entered with valid entries being 0 - 9 and A - C where A = *, B = # and C = 2 seconds pause.

A flashing cursor will appear in the lower left corner of the screen. Enter the first digit then press the right arrow key to move the cursor to the right one position. Enter the second digit and repeat the process until all digits are entered. Press the *Enter* key to store the phone number in memory.

Enter the digits as you would like the number to be dialed. For example, if it's necessary to dial 9 before dialing a number outside the building, you may wish to pause after dialing 9. Enter 9 followed by *D* for a three second pause or *E* for a five second pause then the phone number followed by an *F* to indicate the end of the number.

CENTRAL STATION
1=COMM FORMAT

Primary/Secondary Screen #3

Communication Format

Pressing 1 while viewing Primary/Secondary Screen #3 will cause the following screen to be displayed:

COMM FORMAT
1=ADEMCO CONTACT ID
2=SIA 8
3=SIA 20

The Communication Format is determined by the type of receiver that the DACT is transmitting to. Consult your Central Station for proper selection or consult our factory representatives. For any format chosen, the control panel automatically programs all of the event codes.

Select the Communication Format by pressing the corresponding number key while viewing the Comm Format screen. The following table describes each format:

Table 3.2 Communication Formats

Screen Selection	Communication Format Description
ADEMCO CONTACT ID	Contact ID, DTMF, 1400/2300 ACK
SIA 8	Security Industry Association, 8 messages per call
SIA 20	Security Industry Association, 20 messages per call

CENTRAL STATION
1=EVENT CODES

Primary/Secondary Screen #4

Event Codes

Pressing 1 while viewing Primary/Secondary Screen #4 will cause the following screen to be displayed:

EVENT CODES 
1=PULL STATION
2=MON-USER-DEF-1
3=WATERFLOW

Event Code Screen

Pressing the down arrow key allows viewing of all Events associated with the selected Communication Format. Pressing the number corresponding to the event displayed in each screen will display its default event code which can be customized by the programmer. For example, pressing 1 for Pull Station will display the following screen which allows the Event Code to be changed from the default value.

PULL STATION
ALARM 000

Event Code Screen

The tables on the following pages list all of the Events and their default Event Codes for the various Communication Formats.

Ademco Contact ID & SIA Formats

The information shown in Table 3.3 is automatically programmed for the Central Station phone number Event Codes when the Ademco Contact ID or SIA Format is selected. Enter 0s for an Event Code Setting to disable the report. Disabled reports will not get called to the Central Station. The programmer may enable the Event Types in programming as described on the previous page.

Table 3.3 Event Codes

Event Description	Ademco Contact ID	SIA	
	Active	Active	Restoral
PULL STATION	115	FA	FH
MON-USER-DEF-1	115	FA	FH
WATERFLOW	113	SA	SH
MON-USER-DEF-2	113	SA	SH
SMOKE (PHOTO)	111	FA	FH
DET-USER-DEF-1	111	FA	FH
SMOKE (ION)	111	FA	FH
DET-USER-DEF-2	111	FA	FH
HEAT DETECT	114	KA	KH
DET-USER-DEF-3	114	KA	KH
SMOKE DUCT-P	116	FA	FH
DET-USER-DEF-4	116	FA	FH
PHOTO W/HEAT	111	FA	FH
DET-USER-DEF-5	111	FA	FH
DUCT SUPERVISORY	200	FS	FV
DET-USER-DEF-6	200	FS	FV
PHOTO SUPERV	200	FS	FV
DET-USER-DEF-7	200	FS	FV
PHOTO ADAPT	111	FA	FH
DET-USER-DEF-8	111	FA	FH
PHOTO BEAM	111	FA	FH
DET-USER-DEF-9	111	FA	FH
not used	000	00	00
not used	000	00	00
not used	000	00	00
not used	000	00	00
not used	000	00	00
not used	000	00	00
not used	000	00	00
not used	000	00	00
not used	000	00	00
not used	000	00	00
not used	000	00	00
not used	000	00	00
MONITOR	110	FA	FH
MON-USER-DEF-3	110	FA	FH
not used	000	00	00
not used	000	00	00
SMOKE CONVEN	111	FA	FH
MON-USER-DEF-5	111	FA	FH
HEAT CONVENTIONAL	114	KA	KH
MON-USER-DEF-6	114	KA	KH
MEDIC ALERT	100	MA	MH
MON-USER-DEF-7	100	MA	MH
HAZARD ALERT	150	PA	PH
MON-USER-DEF-8	150	PA	PH
TORNADO ALRT	150	PA	PH
MON-USER-DEF-9	150	PA	PH
MON-PHONE	000	00	00
MON-USER-DEF-10	000	00	00
TAMPER	144	TA	TH
MON-USER-DEF-11	144	TA	TH
MON SUPERVISORY	200	FS	FV
MON-USER-DEF-12	200	FS	FV
MON SUPERV AUTO	200	FS	FV

Table 3.3 Event Codes (continued)

MON-USER-DEF-13	200	FS	FV
HVAC OVRRIIDE	200	FS	FV
POWER MON	330	AT	AR
MON-USER-DEF-14	330	AT	AR
TROUBLE MON	POINT_FAULT code will always be transmitted		
MON-USER-DEF-15	POINT_FAULT code will always be transmitted		
PROCESS MON	000	00	00
MON-USER-DEF-16	000	00	00
PROCMON AR	000	00	00
MON-USER-DEF-17	000	00	00
not used	000	00	00
not used	000	00	00
POINT_FAULT	380	FT	FJ
POINT_DISABLE	570	FB	FU
AC_FAIL	301	AT	AR
DRILL	604	FI	FK
SLC 1 OPEN FAULT	371	ET1	ER1
SLC 1 SHORT FAULT	372	ET1	ER1
not used	000	00	00
not used	000	00	00
GROUND FAULT	310	ET	ER
LOW BATTERY	302	YT	YR
NO_BATTERY	311	YT	YR
TELCO LINE 1	351	LT	LR
TELCO LINE 2	352	LT	LR
COMM FAULT 1	354	YC	YK
COMM FAULT 2	354	YC	YK
TOTAL COMM FLT	000	00	00
PRINTER FAULT	336	VT	VR
NAC 1 FAULT	321	YA	YR
NAC 2 FAULT	322	YA	YR
NAC 3 FAULT	326	YA	YR
NAC 4 FAULT	327	YA	YR
24 VDC FAULT	300	YP	YQ
VOICE EVAC FAULT	330	ET	ER
ACS/ANN-BUS FAULT	333	EM	EN
LCD_80F FAULT	330	EM	EN
NAC 1 DISABLE	521	ET	ER
NAC 2 DISABLE	522	ET	ER
NAC 3 DISABLE	526	ET	ER
NAC 4 DISABLE	527	ET	ER
CS CALC FAULT	304	YF	
CHARGER FAULT	300	YP	YQ
OPTION CARD 1 FAULT	331	ET	ER
REMOTE SYNC FAULT	332	OU	OV
not used	000	00	00
ZONE DISABLE	570	FB	FU
NAC_KEY_FLT	300	ET	ER
NO_DEVICES_INSTLLD	380	ET	ER
OFF_NORMAL_MESSAGE	308	LB	LX
24_HOUR_TEST	602	RP	
24 HOUR ABNORMAL TES	608	RY	
UPDOWN REQUEST	411	RB	
UPLOAD SUCCESS	416	RS	
DOWNLOAD SUCCESS	412	RS	
UPDOWN FAILURE	413	RR	
GENERAL_ALARM	000	00	00
GENERAL_SUPERVISORY	000	00	00

```

CENTRAL STATION
1=PRIMARY
2=SECONDARY
3=REPORT STYLE POINT

```

Central Station Screen #2

Report Style

Pressing 3 while viewing Central Station Screen #2 will cause the Report Style display to toggle between *Point* and *Zone*. Setting the Report Style to Point will program the DACT to report individual point status to the Central Station. The control panel is capable of monitoring a total of 198 addressable devices. Setting the Report Style to Zone will program the DACT to report zone status to the Central Station. The control panel is capable of monitoring a total of 99 individual zones.

Notes:

1. Detector Address 01 will be reported to the Central Station as Point 01, Detector Address 02 as Point 02, with reports continuing in a similar fashion all the way up to Detector Address 99 which will be reported as Point 99.
2. Module Address 01 will be reported to the Central Station as Point 160, Module Address 02 will be reported to the Central Station as Point 161, with reports continuing in a similar fashion all the way up to Module Address 99 which will be reported as Point 258.

```

ON BOARD DACT
1=FUTURE USE
2=CENTRAL STATION
3=SUPERV PHONE LINE

```

On Board DACT Screen #2

3.6.9.2.7 Supervised Phone Line

The Supervised Phone Line feature allows the user to disable the supervision of Phone Line 2 by the DACT when using an alternate means of secondary transmission path. The factory default setting is Phone Line 2 supervised.

Pressing 2 for *Superv Phone Line* while viewing Onboard DACT Screen 2 will cause the following screen to be displayed:

```

SUPERVISE PHONE LINE
1=PHONE LINE 2   YES

```

Panel ID Screen

Each press of the 1 key while viewing this screen will toggle the option between Supervise Phone Line 2 Yes and No.

```

OPTION MODULES
1=ANNUNCIATORS/UDACT
2=ON BOARD DACT
3=PRINTER/PC  NO

```

Option Module Screen

3.6.9.3 Printer/PC

A Printer or a PC can be connected to the control panel. Pressing 3 while viewing the Option Module Screen will cause the following screen to appear:

```

          PRINTER-PC
1=PRINTER NO SU    NO
2=PRINTER SU      YES
3=PC              NO

```

Printer-PC Screen

Pressing 1 while viewing the Printer-PC Screen will program the control panel for an unsupervised (*NO SU*) printer. The display will change to the Printer Baud Rate Screen as shown below.

Pressing 2 while viewing the Printer-PC Screen will program the control panel for a supervised (*SU*) printer. Printer supervision, when enabled, will typically detect the removal of the printer cable and will detect when the printer power has been turned off. Depending upon the brand of printer, other errors such as paper empty or printer off-line may be detected.

The following screen will appear, which allows the programmer to select the baud rate for the printer communication:

```

          PRINTER BAUD RATE
1=2400 BAUD
2=4800 BAUD
3=9600 BAUD

```

Printer Baud Rate Screen

Pressing the number key corresponding to the desired baud rate (2 for 4800 Baud for example) will program the control panel for the selected baud rate and return the display to the Option Module Screen which will indicate *Printer/PC PR4800* for a supervised printer installed at 4800 baud rate.

Pressing 3 while viewing the Printer-PC Screen will program the control panel for a PC connection. The display will return to the Option Module Screen which will indicate *Printer/PC PC* for personal computer installed.

Note: The LCD-80F and the Printer/PC use the same TB8 terminal block. Only one device can be used at any one time. Setting any option in the Printer/PC screen to Yes will disable communications with the LCD-80F. The printer must be installed in the same room and within 50 feet of the FACP.

3.6.10 Password Change

PROGRAMMING
1=PASSWORD CHANGE
2=CLEAR PROGRAM
3=PROGRAM CHECK

Programming Screen #4

The factory set passwords, which have been programmed into the control panel, can be changed by selecting the Password Change option. Pressing *1* while viewing Programming Screen #4 will cause the following screen to be displayed:

PASSWORD CHANGE
1=MASTER
2=MAINTENANCE
3=REMOTE DOWNLOAD

Password Change Screen

Press *1* to change the Master Programming Level password, *2* to change the Maintenance Level password or *3* to change the Remote Download password. *Note that the passwords will not be displayed on LCD annunciators.*

The following screen will appear when any change option is selected:

ENTER NEW FIVE DIGIT
PASSWORD

Enter Password Screen

A flashing cursor will appear in the center of the display. Enter a new five digit password (such as 10101 for the Master Level). After the fifth digit is entered, the following screen will be displayed:

VERIFY NEW PASSWORD

Password Change Screen

Re-enter the new password to accept the change. The display will return to the initial Password Change Screen.

3.6.11 Clear Program

```

PROGRAMMING
1=PASSWORD CHANGE
2=CLEAR PROGRAM
3=PROGRAM CHECK
    
```

Programming Screen #4

Pressing 2 while viewing Programming Screen #4, will select the Clear Program option. This will cause the LCD to display the following screen:

```

CLEAR PROGRAM
1=WHOLE SYSTEM
2=ALL POINTS
    
```

Clear Program Screen #1

Pressing 1, for Whole System while viewing the Clear Program Screen #1, will clear all general system programming options and all programmed addressable devices from the nonvolatile memory of the FACP. *This function is useful when the control panel is first installed, prior to autoprogramming. Note that it is necessary to autoprogram after using the Clear Whole System function.*



Pressing 2, for ALL POINTS while viewing the Clear Program Screen #1, will clear all programming related to the SLC loop and connected addressable devices.

Before executing any of the Clear commands listed above, the control panel will provide a warning to the user by prompting with the following display:

```

WARNING!
SYSTEM CHANGE
PROCEED?
1=YES          2=NO
    
```

Pressing 1 will cause the control panel to carry out the selected clear option. Pressing 2 will prevent programming from being cleared.

3.6.12 Program Check

PROGRAMMING
1=PASSWORD CHANGE
2=CLEAR PROGRAM
3=PROGRAM CHECK

Programming Screen #4

The Program Check feature allows the programmer to view the zones which have been programmed to the Notification Appliance Circuits on the control panel but have not been programmed to Initiating Devices as well as other circuits with no input or output correlations. Pressing 3 while viewing Programming Screen #4 will cause the following screen to be displayed:

PROGRAM CHECK
1=NACS NO INPUT
2=ZONES NO INPUT
3=ZONES NO OUTPUT

PROGRAMCHECK
1=NACS NO INPUT
2=ZONES NO INPUT
3=ZONES NO OUTPUT

Program Check Screen

Pressing 1 while viewing the Program Check screen will display an NAC screen similar to the following.

NACS NO INPUT
NAC 1
25 31 44 55 67

The example above indicates that NAC 1 has been programmed to Zones 25, 31, 44, 55 and 67 but no input devices have been programmed to any of these zones. Use the up and down arrow keys to view all the NAC zones without input assignments for NAC 1, NAC2, NAC 3 and NAC 4.

Note: If the NACs have been configured for Class A in the Setup option, only NAC1 and NAC 2 will display test information. NAC 3 and NAC 4 will display asterisks () and will not be included in the test.*

Pressing 2 while viewing the Program Check screen will display a screen similar to the following:

```
ZONES NO INPUT
05 07 09 10 11 1M001
```

The Zone No Input screen allows the programmer to view the zones which have not been programmed to at least one input device (not including general alarm Zone 00). The example in the preceding screen indicates that Zones 05, 07, 09, 10 and 11 have been programmed to an addressable module (control module in this example) with an address of 001 on loop 1 but have not been programmed to any input devices. Use the up and down arrow keys to view all the zones without input assignments.

Pressing 3 while viewing Program Check screen will cause a screen similar to the following to be displayed:

```
ZONES NO OUTPUT
05 07 09 10 11 1D001
```

The Zone No Output feature allows the programmer to view the zones which have not been programmed to at least one output device (not including general alarm Zone 00). The example in the preceding screen indicates that Zones 05, 07, 09, 10 and 11 have been programmed to an addressable detector with an address of 001 on loop 1 but have not been programmed to any output devices. Use the up and down arrow keys to view all the zones without output assignments.

3.7 Maintenance Programming Level

To access Maintenance Programming mode, press the *Enter* key. The LCD will display the following:

```
1=READ STATUS
2=PROGRAMMING
3=REMOTE DOWNLOAD
```

To enter the Maintenance Programming mode, press 2. The display will read as follows:

```
PROGRAMMING
ENTER PASSWORD
```

When the *Maintenance* level password (default *1111*) is entered, the following screen will appear:

```
PROGRAMMING
1=POINT PROGRAM
2=HISTORY
3=PROGRAM CHECK
```



Note that in the preceding screens, an arrow appears to inform the programmer that additional options can be viewed by pressing the keypad *down* arrow key, as shown in the following screen.

```
PROGRAMMING
1=WALKTEST
2=SYSTEM
3=ZONE SETUP
```



3.7.1 Disable Point

```

PROGRAMMING
1=POINT PROGRAM
2=HISTORY
3=PROGRAM CHECK
    
```

Maintenance Screen #1

Pressing *1* for Point Program, while viewing Maintenance Screen #1 will cause the following screens to be displayed:

```

POINT PROGRAM
1=DETECTOR
2=MODULE
    
```

Device Select Screen

Select the device type by pressing *1* for an addressable detector or *2* for an addressable module. The operator will be prompted to enter the three digit device address as shown in the following example for a detector:

```

EDIT DETECTOR
ENTER POINT ADDRESS
**
    
```

Address Select Screen

A flashing cursor will appear in the bottom left corner of the display, prompting for the three digit device address. When the third digit is enter, *001* for example, a screen will appear which will allow enabling or disabling of the selected point, as illustrated in the following example:

```

EDIT DETECTOR 10001
1=ENABLED          YES
    
```

Enable/Disable Select Screen

Pressing *1* repeatedly will cause the display to toggle between *Enabled Yes* and *Enabled No*.

3.7.2 History

```

PROGRAMMING
1=POINT PROGRAM
2=HISTORY
3=PROGRAM CHECK

```

Maintenance Screen #1

Pressing 2 while viewing Maintenance Screen #1 will cause the following screen to be displayed:

```

HISTORY
1=VIEW EVENTS
2=ERASE HISTORY

```

History Screen

The History feature allows the operator to view control panel events which have been stored in a history file in memory and erase the contents of the history file

Pressing 1 while viewing the History screen will cause the following screen to be displayed:

```

HISTORY
1=VIEW ALL
2=VIEW ALARMS
3=VIEW OTHER EVENTS

```

Events Screen

To view all the events which have occurred in the control panel since the history file was last erased, press 1 while viewing the Events screen. To view only alarms which have occurred, press 2 while viewing the Events screen. To view events other than alarms, press 3. The most recent event will be displayed on the screen. To view all of the selected events, press the up or down arrow keys to scroll through the list of events. If no events have occurred, the display will read *NO EVENTS IN HISTORY*.

Pressing 2 while viewing the History Screen will cause the following screen to be displayed:

```

ERASE HISTORY
PROCEED ?
1=YES          2=NO

```

Erase History Screen

Pressing 1 while viewing the Erase History Screen will cause the message *ERASING HISTORY, PLEASE WAIT* to be displayed. The display will then return to the History Screen. Pressing 2 will cause the display to return to the History Screen without erasing the History file.

3.7.3 Program Check

```

PROGRAMMING
1=POINT PROGRAM
2=HISTORY
3=PROGRAM CHECK
    
```

Maintenance Screen #1

Pressing 3 while viewing Maintenance Screen #1 will cause the following screen to be displayed:

```

PROGRAM CHECK
1=NACS NO INPUT
2=ZONES NO INPUT
3=ZONES NO OUTPUT
    
```

Program Check Screen

The Program Check feature allows the programmer to view the zones which have been programmed to the Notification Appliance Circuits on the control panel but have not been programmed to Initiating Devices as well as other circuits with no input or output correlations. Pressing 1 while viewing Program Check screen will cause a screen similar to the following to be displayed.

```

NACS NO INPUT
NAC 1
  25 31 44 55 67
    
```

The example above indicates that NAC 1 has been programmed to Zones 25, 31, 44, 55 and 67 but no input devices have been programmed to any of these zones. Use the up and down arrow keys to view all the NAC zones without input assignments for both NAC 1, NAC 2, NAC 3 and NAC 4.

Note: If the NACs have been configured for Class A in the Setup option, only NAC 1 and NAC2 will display test information. NAC 3 and NAC 4 will display asterisks () and will not be included in the test.*

Pressing 2 while viewing the Program Check screen will display a screen similar to the following:

```

ZONES NO INPUT
05 07 09 10 11 1M001
    
```

The Zone No Input screen allows the programmer to view the zones which have not been programmed to at least one input device (not including general alarm Zone 00). The example in the preceding screen indicates that Zones 05, 07, 09, 10 and 11 have been programmed to an addressable module (control module in this example) with an address of 001 on loop 1 but have not been programmed to any input devices. Use the up and down arrow keys to view all the zones without input assignments.

Pressing 3 while viewing Program Check screen will cause a screen similar to the following to be displayed:

```

ZONES NO OUTPUT
05 07 09 10 11 10001

```

The Zone No Output feature allows the programmer to view the zones which have not been programmed to at least one output device (not including general alarm Zone 00). The example in the preceding screen indicates that Zones 05, 07, 09, 10 and 11 have been programmed to an addressable detector with an address of 001 on loop 1 but have not been programmed to any output devices. Use the up and down arrow keys to view all the zones without output assignments.

3.7.4 Walktest

```

PROGRAMMING
1=WALKTEST
2=SYSTEM
3=ZONE SETUP

```

Maintenance Screen #2

To perform a walktest, press 1 while viewing Maintenance Screen #2. The following screen will be displayed:

```

WALKTEST
1=SILENT
2=AUDIBLE
3=VIEW RESULT

```

Walktest Screen

The operator can press 1 to perform a silent walktest or 2 to perform an audible walktest. Pressing 1 or 2 will cause the control panel to enter Walktest Mode and will display the following screen:

```

UNIT IN WALKTEST
1=VIEW WALKTEST LOG
2=VIEW POINTS
3=VIEW SUMMARY

```

Unit In Walktest Screen

From this screen, it is possible to view the walktest log, untested system points or a summary of the addressable devices tested during the current walktest. The user can select between any of these screens without interrupting the current walktest session. The walktest session will not end until the Unit In Walktest screen is exited by pressing the Escape key to return to the Walktest Screen.

Pressing 1 for *View Walktest Log* while viewing the Unit In Walktest screen will cause a screen similar to one of the following two screens to be displayed:

```

NO EVENTS IN
WALKTEST LOG
    
```

OR

```

ALARM: MONITOR
      NORTH CLASSROOM
              2001
10*15A 012308 1M006
    
```

If there are no events in the current walktest session, the first screen will be displayed, indicating no events have been stored in the walktest log. If any events have been stored, a screen similar to the second will be displayed indicating the latest event. As walktest events occur, the display will change to indicate the latest event. All stored events can be scrolled on the screen by pressing the up or down arrow keys. To return to the first event, press the *1st Event* key.

Pressing 2 for *View Points* while viewing the Unit In Walktest screen will display one of the following screens:

```

NO POINTS IN
SYSTEM
    
```

OR

```

UNTESTED POINTS  010
1D001  SMOKE (PHOTO)
*****
NOT TESTED
    
```

If the system has no points installed, the first screen will be displayed. If points are installed, the second screen will be displayed, which allows the viewing of all untested system points and their status relating to the current walktest session. The up and down arrow keys will allow viewing of all untested points. If a point is tested while it is being displayed, the screen will update and display the next untested point. The first line indicates the total number of untested points. The second line displays information about an untested point. A description on the bottom of the screen will indicate if the displayed point has been disabled, if the Walktest option has been disabled for that point or if the point is not yet tested. The up and down arrow keys allow the user to scroll through all untested points.

Pressing 3 for *View Summary* while viewing the Unit In Walktest screen will display a new screen which will show a total of the tested detectors, tested modules, untested detectors and untested modules for the current walktest session.

To end the Walktest session, press the Escape key to return to the Walktest screen. Pressing 3 for *View Results* while viewing the Walktest screen, after a walktest session has been completed, will allow the operator to view the final results of the most recent walktest.

3.7.5 System

To program the time and date into the control panel, press 2 while viewing Maintenance Screen #2. The following display will appear:

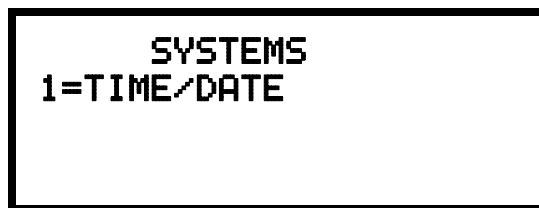

System Screen

Pressing 1 while viewing the System Screen will cause the following screen to be displayed:

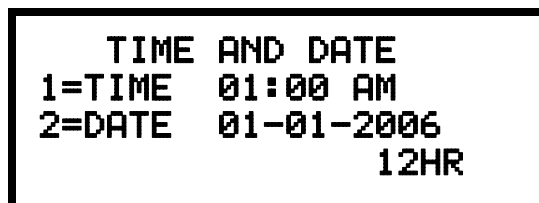

Time and Date Screen

To change the time, press 1 to display the following screen:



Time Screen

A flashing cursor will appear on the left side of the display. Enter the four digit number corresponding to the time (0000 - 1259). When the fourth digit is entered, the cursor will move one position to the right. Press 1 for AM or 2 for PM to complete entering the time. The display will return to the Time and Date Screen displaying the new time.

To change the date, press 2 while viewing the Time and Date Screen. The following screen will be displayed:



Date Screen

A flashing cursor will appear on the left side of the display. Enter the two digit month, two digit day and four digit year. The cursor will move one position to the right after each entry. When the fourth digit of the year has been entered, the display will return to the Time and Date Screen which will show the new date.

3.7.6 Zone Setup

```
PROGRAMMING
1=WALKTEST
2=SYSTEM
3=ZONE SETUP
```

Maintenance Screen #2

Pressing 3 while viewing Maintenance Screen #2 will display the following screen:

```
ZONE SETUP
1=ENABLE
2=DISABLE
3=ZONE 97 98 99
```

Zone Setup Screen

Pressing 1 while viewing Zone Setup screen will display the following screen:

```
ZONE TO ENABLE
Z
```

Enable Screen

A flashing cursor appears to the right of the Z. To enable a zone, enter the two digit zone number (00 - 99). After the second digit is entered, the zone will be enabled and the cursor will return to the original position. The next zone to be enabled can then be entered. Press Esc (Escape) to return to the previous screen.

Pressing 2 while viewing Zone Setup screen will display the following screen:

```
ZONE TO DISABLE
Z
```

Disable Screen

A flashing cursor appears to the right of the Z. To disable a zone, enter the two digit zone number (00 - 99). After the second digit is entered, the zone will be disabled and the cursor will return to the original position. The next zone to be disabled can then be entered. Press Esc (Escape) to return to the previous screen.

Pressing 3 while viewing Zone Setup screen will display the following screen:

SPEC PURPOSE ZONE		
1=PAS 97		OFF
2=PRE-SIGNAL 98		OFF
3=TWO STAGE 99		OFF

Disable Screen

Zones 97, 98 and 99 can be programmed for normal zone operation or for special purpose applications. In the above illustration, the three zones are shown Off, which means they can be programmed to function in the same manner as all other zones, by assigning them to input and output devices in the Programming Zone Assignment Screen.

Pressing 1 will cause the display to change to *PAS 97 On*. Each press of the 1 key will cause the display to toggle between *PAS 97 On* and *PAS 97 Off*. When Zone 97 is programmed On, a PAS (Positive Alarm Sequence) activation of any smoke detector will cause Zone 97 to activate. By assigning Zone 97 to a control module in the Programming Zone Assignment Screen, an output device connected to the control module can be used to indicate a PAS condition in the control panel. *Do not assign Zone 97 to a Notification Appliance Circuit when using this zone to indicate a PAS condition.*

Pressing 2 will cause the display to change to *Pre-signal 98 On*. Each press of the 2 key will cause the display to toggle between *Pre-signal 98 On* and *Pre-signal 98 Off*. When Zone 98 is programmed On, a Pre-signal activation of any device will cause Zone 98 to activate. By assigning Zone 98 to a control module in the Programming Zone Assignment Screen, an output device connected to the control module can be used to indicate a Pre-signal condition in the control panel. *Do not assign Zone 98 to a Notification Appliance Circuit when using this zone to indicate a Pre-signal condition.*

Pressing 3 will cause the display to change to *Two Stage 99 On*. Each press of the 3 key will cause the display to toggle between *Two Stage 99 On* and *Two Stage 99 Off*. Refer to "Two Stage Operation" on page 108 for a description of this feature.

SECTION 4 Operating Instructions

4.1 Panel Control Buttons

4.1.1 Acknowledge/Step

The first press of the *Acknowledge/Step* key silences the piezo sounder, changes flashing LEDs to steady and also changes the status field on the LCD display from capital letters to small letters. When the piezo is silenced, an *acknowledge* message is sent to the printer and the history file. *Acknowledge* also sends a *silence piezo* command to the optional annunciators connected to the FACP.

When more than one event exists, the first press of the Acknowledge/Step key functions as described in the preceding paragraph. Subsequent pressing of the key *steps* through each off-normal active event, with alarm events having a higher priority than trouble and supervisory events.

4.1.2 Alarm Silence

The *Alarm Silence* key performs the same functions as Acknowledge/Step. In addition, if an alarm exists, it turns off all silenceable NACs (Notification Appliance Circuits) and causes the Alarm Silenced LED to turn on. It also sends an 'alarm silenced' message to the printer, history file and optional annunciators. A subsequent new alarm will resound the system NACs. *Note that the Alarm Silenced LED is turned off by pressing the Reset key, the Drill key or subsequent activation of the NACs.*

4.1.3 Drill/Hold 2 Sec

When the *Drill* key is held for a minimum of two seconds (time required to prevent accidental activations), the FACP turns on both main panel NAC outputs and all silenceable circuits such as control modules that are programmed as silenceable, and turns off the Alarm Silenced LED if it was previously on. The *EVAC IN SYSTEM* message is shown on the LCD display. The same message is sent to the printer and history file. The *Alarm Silence* key can be used to turn off all silenceable NAC outputs following activation by the *Drill* key.

4.1.4 Reset

Pressing and releasing the *Reset* key turns off all control modules and NACs, temporarily turns off resettable power to 4-wire detectors, causes a *RESET IN SYSTEM* message to be displayed on the LCD and sends the same message to the printer and history file. It also performs a lamp test by turning on all LEDs (except the Ground LED), piezo sounder and LCD display segments after the *Reset* key is released. Any alarm or trouble that exists after a reset will resound the system.

4.2 LED Indicators

The nine LED indicators, which are located on the front panel, operate as follows:

AC Power

This is a green LED which illuminates if AC power is applied to the FACP. A loss of AC power will turn off this LED

Fire Alarm

This red LED flashes when one or more alarms occur. It illuminates steady when the *Acknowledge/Step* or *Alarm Silence* key is pressed. The Fire Alarm LED turns off when the *Reset* key is pressed. The LED will remain off if all alarms have been cleared.

Supervisory

This is a yellow LED that flashes when one or more supervisory conditions occur, such as a sprinkler valve tamper condition. It illuminates steady when the *Acknowledge/Step* or *Alarm Silence* key is pressed. It turns off when the *Reset* key is pressed and remains off if all supervisory alarms have been cleared.

Trouble

This is a yellow LED that flashes when one or more trouble conditions occur. It stays on steady when the *Acknowledge/Step* or *Alarm Silence* key is pressed. The LED turns off when all trouble conditions are cleared. This LED will also illuminate if the microprocessor watchdog circuit is activated.

Maintenance

This is a yellow LED that flashes to indicate that a smoke detector requires cleaning or replacement due to an invalid chamber reading or excessive drift.

Alarm Silenced

This is a yellow LED that turns on after the *Alarm Silence* key is pressed while an alarm condition exists. It turns off when the *Drill* or *Reset* key is pressed.

Disabled

This is a yellow LED that flashes to indicate that a zone, NAC, detector or module has been temporarily disabled in programming by the user.

Battery

This is a yellow LED that flashes to indicate a low battery voltage condition.

Ground

This is a yellow LED that flashes to indicate a ground fault condition (zero impedance from the FACP to ground).

Primary Line Active

This is a red LED that indicates the primary phone line is active.

Secondary Line Active

This is a red LED that indicates the secondary phone line is active

Kiss-off

This is a green LED that blinks when a Central Station has acknowledged receipt of each transmitted message or when a portion of upload or download data has been accepted from a Service Terminal

4.3 Normal Operation

With no alarms or troubles in the system, the display message is *System All Normal* along with the current time and date as shown below. To set the time and date, refer to the appropriate section in this manual.



The MS-9200UDLS performs the following functions at regular intervals while in Normal mode:

- ✓ Monitors AC input voltage and battery voltage
- ✓ Monitors and reports status of SLC loop, option cards and control panel
- ✓ Polls all devices on the SLC loop and flashes each device LED while checking for valid replies, alarms, troubles, etc.
- ✓ Refreshes LCD display and updates time
- ✓ Scans control panel keypad for key presses
- ✓ Performs autotest for all SLC devices
- ✓ Tests memory
- ✓ Updates and reads all communications busses (EIA-485, EIA-232, etc.)

4.4 Trouble Operation

With no alarms in the system, the detection of a trouble will cause the following:

- The piezo to pulse 1 second On and 1 second Off
- The system Trouble LED to flash one second On and one second Off
- The trouble relay to activate
- *TROUBL* with device type, noun/adjective, address and trouble description will appear on the LCD display
- The same message, along with the time and date, is sent to the optional printer and the history buffer.
- Communicate the trouble conditions to the Central Station
- Terminate upload or download communications

Note that specific troubles will initiate additional actions; for example, loss of AC power will turn off the AC Power LED, a ground fault will turn on the Ground LED, etc.

Addressable Smoke Detectors, Monitor Modules and Control Modules

For addressable devices connected to the SLC loop, the following is a typical message that could appear on the LCD display for a device trouble:

```

TROUBL SMOKE (PHOTO)
      <ADJ> <NOUN>
                INVREP
10:00A 010806 10001
  
```

The information displayed in the above example provides the following information:

- First line in display:
 - ✓ The type of event; in this example *TROUBL* indicating a device trouble
 - ✓ Device type identifier; in this example, *SMOKE (PHOTO)* indicates a Photoelectric smoke detector. Other device type identifiers which can be displayed include *SMOKE (ION)* for Ionization Detector, *HEAT* for Heat Detector, *CONTROL* for Control Module and *MONITOR* for Monitor Module, *PULL STATION* for a manual pull box, etc. Refer to "Edit Detector" on page 66, "Edit Module Screen for Monitor Module" on page 76 and "Edit Module Screen for Control Modules" on page 85 for information on additional device types.
- Second line in display:
 - ✓ <ADJ>; refers to the user programmed adjective descriptor from library list resident in the control panel or custom entry via PC.
 - ✓ <NOUN>; refers to the user programmed noun descriptor from library list resident in the control panel or custom entry via PC.
- Third line in display: *INVREP* indicates an invalid reply from the addressable device. Other possible troubles include:
 - SHORT* - indicating a shorted circuit on an addressable device
 - OPEN* - indicating an open circuit on an addressable device
 - DIRTY1* - maintenance alert indicating that a detector is near but below the allowed alarm limit and is in need of maintenance before the performance is compromised
 - DIRTY2* - maintenance alert indicating that a detector needs immediate maintenance since it has been within 80% of its alarm threshold for 24 hours
 - INVREP* - maintenance alert indicating a hardware problem in the detector
 - TEST F* - indicating a detector has failed the automatic test operation which functionally checks its sensing chamber and electronics
 - INV ID* - indicating that an incorrect device code (Type ID) has been programmed for an installed device (for example, Photo has been programmed but an Ion detector has been installed)
 - SW TBL* - indicating a module has failed the testing of its Class A switching relay
- Fourth line in display:
 - ✓ Time; the current time in this example is *10:00A* which represents 10:00 AM
 - ✓ Date; the current month, day and year in this example is *01* for January, *08* for the 8th day of the month and *01* for the year 2001
 - ✓ Device Address; *10001* in this example *1* represents SLC Loop, *D* represents a detector and *001* represents device address 001

Pressing the *Acknowledge/Step* or *Alarm Silence* key will cause the pulsing piezo to silence and the system Trouble LED to change from flashing to on steady. This block acknowledgment occurs regardless of the number of troubles, alarms and supervisory events active in the system. When the *Acknowledge/Step* key is pressed and at least one new alarm or trouble exists in the system, the 'acknowledge' message is sent to the printer and history file. If the trouble clears, either before or after the *Acknowledge/Step* key is pressed, the 'clear trouble' message is sent to the printer and history file.

If all troubles clear and there are no supervisory or fire conditions active in the system, the system returns to normal mode operation and the *System All Normal* message is shown on the LCD display and sent to the history and printer files. The auto-restore feature will restore cleared troubles even if the troubles were never acknowledged. Note that pressing the *Alarm Silence* key when only troubles exist in the system will have the same effect as pressing the *Acknowledge/Step* key except the Alarm Silenced LED will light.

4.5 Alarm Operation

Alarm operation is similar to trouble operation with the following differences:

- The piezo sounder produces a steady output as opposed to a pulsed output
- The Fire Alarm LED flashes 1 second On and 1 second Off
- The LCD displays *Alarm* along with the device name, type, address, adjective/noun, associated zones and time/date
- Communicate the alarm to the Central Station
- Alarms latch and *are not allowed to clear automatically*
- Alarms activate software zones if so programmed
- Timers for Silence Inhibit, Autosilence and Trouble Reminder are started
- Alarms activate the general alarm relay and general alarm zone Z00
- The trouble relay is not activated
- Store event in history buffer
- Terminate upload or download communications
- Alarms must be Acknowledged before the FACP can be reset

A typical alarm display would be as illustrated below:

```

ALARM  PULL STATION
      <ADJ> <NOUN>
                Z000
10:00A 010806 1M001
  
```

Note that the device type, which in this example is *PULL STATION*, can be any other programmable alarm type.

The information displayed in the above example provides the following information:

- First line in display:
 - ✓ The type of event; in this example *ALARM* indicating an alarm condition
 - ✓ Device type identifier; in this example, *PULL STATION* indicates a manual pull box. Other device type identifiers which can be displayed include *SMOKE (ION)* for Ionization Detector, *HEAT* for Heat Detector, *CONTROL* for Control Module and *MONITOR* for Monitor Module, *PULL STATION* for a manual pull box, etc. Refer to "Edit Detector" on page 66, "Edit Module Screen for Monitor Module" on page 76 and "Edit Module Screen for Control Modules" on page 85 for information on additional device types.
- Second line in display:
 - ✓ <ADJ>; refers to the user programmed adjective descriptor from library list resident in the control panel or custom entry via PC.
 - ✓ <NOUN>; refers to the user programmed noun descriptor from library list resident in the control panel or custom entry via PC.

- Third line in display: *Z000* indicates the zone programmed to this device which, in this example, is general alarm Zone 000. Note that a single device can be programmed to five different zones but only the first zone will be displayed.
- Fourth line in display:
 - ✓ Time; the current time in this example is *10:00A* which represents 10:00 AM
 - ✓ Date; the current month, day and year in this example is *01* for January, *08* for the 8th day of the month and *01* for the year 2001
 - ✓ Device Address; *1M001* in this example *1* represents SLC Loop, *M* represents a module and *001* represents device address 001

4.6 Supervisory Operation

Supervisory operation is similar to alarm operation but with the following differences:

- The piezo sounder pulses ½ second On and ½ second Off
- The Supervisory LED flashes ½ second On and ½ second Off
- The LCD displays the status label *Active Supervisory* along with the device name, type, address, adjective/noun, associated zones and time/date
- Communicate the supervisory condition to the Central Station
- The supervisory relay is activated
- The alarm relay is not activated
- NACs will not activate
- Silenced alarms are not resounded
- Timers are not started
- Store event in history buffer
- Terminate upload or download communications
- Supervisory condition must be Acknowledged before the FACP can be reset

A typical Supervisory event would be displayed as illustrated in the following:

```

ACTIVE SUPERVISORY
  <ADJ> <NOUN>
                                Z000
10:00A 010806 1M001
  
```

Note that, like alarms, supervisory signals latch (except when programmed for supervisory autoresettable) and can be assigned to software zones. Supervisory events do not cause resound as do other alarm conditions. Open circuits in supervisory wiring are processed by the control panel the same way as other trouble conditions. Refer to "Alarm Operation" on page 160, for a description of the information displayed on the control panel LCD.

4.7 Process Monitor Operation

Process Monitor operation will initiate the following events:

- The piezo sounder pulses ¼ second On and ¼ second Off
- The LCD displays a process monitor message along with the device name, type, address, adjective/noun, associated zones and time/date
- Communicate the process monitor condition to the Central Station
- Relays programmed for process monitoring will be activated
- The alarm relay is not activated
- NACs will not activate
- Silenced alarms are not resounded
- Timers are not started
- Store event in history buffer
- Process Monitor condition must be Acknowledged before the FACP can be reset

Note that, like supervisories, process monitor signals latch (except when programmed for process monitor autoresettable) and can be assigned to software zones.

4.8 Hazard/Tornado Condition Operation

Hazard/Tornado Condition operation will initiate the following events:

- The piezo sounder pulses ½ second On, ½ second Off
- The LCD displays a hazard message along with the device name, type, address, adjective/noun, associated zones and time/date
- Communicate the hazard condition to the Central Station
- Relays programmed for hazard will be activated
- The alarm relay is not activated
- NACs will not activate
- Silenced alarms are not resounded
- Timers are not started
- Store event in history buffer
- Supervisory LED flashes ½ second On, ½ second Off
- Hazard/Tornado Condition must be Acknowledged before FACP can be reset

Hazard conditions latch. They can be assigned to software zones.

4.9 Medical Alert Condition Operation

Medical Alert Condition operation will initiate the following events:

- The piezo sounder ½ second On, ½ second Off
- The LCD displays a medical alert message along with the device name, type, address, adjective/noun, associated zones and time/date
- Communicate the medical alert condition to the Central Station
- Relays programmed for medical alert will be activated
- The alarm relay is not activated
- NACs will not activate
- Silenced alarms are not resounded
- Timers are not started
- Store event in history buffer
- Supervisory LED flashes ½ second On, ½ second Off
- Medical Alert condition must be Acknowledged before FACP can be reset

Medical Alert conditions latch. They can be assigned to software zones.

4.10 NAC Operation

There are four Style Y (Class B) or two Style Z (Class A) programmable NACs (Notification Appliance Circuits) resident on the MS-9200UDLS main circuit board. All NACs may be programmed as silenceable or nonsilenceable and may also be programmed for steady or coded operation. Coded operation provides a choice between March Time, Temporal or California coding.

4.11 Programmed Zone Operation

Each addressable detector and monitor module can be assigned to a maximum of five software alarm zones. A general alarm zone Z00 may be listed for output (control) points, but it is not necessary to list Z00 for input points, since this is the default zone for all alarm input devices. Zone Z00 is not activated by supervisory points.

When an input device alarms and is not disabled, it activates all software zones assigned to it. An output device that is not disabled is turned on when any of the software zones to which it is programmed become active. Only alarms, hazards/tornado alerts can turn on any of the four main NACs.

4.12 Disable/Enable Operation

Input points which are disabled do not cause an alarm or any zone activation. Disabled output points are held in the off state. All disabled points are treated as if they were in trouble, with the exception being the status label that will be displayed is *DISABL*.

4.13 Waterflow Circuits Operation

If an alarm exists from a monitor module point that has a waterflow type code and its mapped NAC control module outputs are programmed for nonsilenceable operation, the Alarm Silence key will not function. Also, any output zone activated by a waterflow device will not be silenceable if the Waterflow Silenceable option is set to NO in system programming.

4.14 Detector Functions

Maintenance Alert

Each addressable detector is monitored by the control panel for its maintenance status. If a detector is near but below the allowed alarm limit, a 'maintenance alert' message will automatically be displayed, signaling that the detector is in need of servicing.

Automatic Test Operation

An automatic test of an addressable detector is performed each minute, resulting in a complete SLC loop test in approximately 5 hours (if the loop has the maximum number of devices installed). The detector's sensing chamber and electronics are functionally tested for normal, safe operation. A trouble message is displayed upon failure of this test. A System Reset will clear this trouble.

Type Code Supervision

The FACP monitors addressable hardware device codes at slow intervals. Mismatch of any type code, compared to the system program, will cause a device trouble.

System Alarm Verification

The control panel may be programmed to perform alarm verification to help eliminate the nuisance of false alarms. Alarm verification applies to smoke detectors only.

Smoke Detector Data

Smoke detector data is monitored by the FACP, eliminating the need to test the sensitivity of each detector at its location. A printout of each detector's data can be retrieved from the FACP using an optional printer or Windows® HyperTerminal. Detector sensing ability can decrease with age and should be monitored as part of a system's routine maintenance.

4.15 Time Functions: Real-Time Clock

The MS-9200UDLS includes a crystal-based clock that provides time of day, date and day of week. Time is displayed as 12 or 24 hour time with month/day/year and is stored in RAM. Daylight savings time change-over is programmable and automatic. If both AC and battery are lost, the time must be reset.

4.16 Synchronized NAC Operation

Synchronization is a panel feature that controls the activation of notification appliances in such a way that all devices will turn on and off at exactly the same time. This is particularly critical when activating strobes which must be synchronized to avoid random activation and a potential hazard or confusion. The FACP can be programmed to operate with a variety of manufacturer's devices. NAC synchronization can only be supported properly by the Remote Power Supply Sync Terminal, which follows NAC 1 programming.

Important: *When a Notification Appliance Circuit with a mix of audible and visual devices is programmed for silenceable and the synchronization feature is selected, only the audible devices will be turned off if the Silence key is pressed. The visual devices (strobes, etc.) will continue to operate.*

4.17 Coded Operation

The NAC circuits resident on the control panel main circuit board can be programmed for coded operation. The available pulse rates which can be programmed for coded operation are as follows:

- Continuous: Steady output with no pulsing
- March Time: Pulses at 120 ppm (pulses per minute)
- Temporal Code: Pulses at ½ second On, ½ second Off, ½ second On, ½ second Off, ½ second On, 1½ second Off
- California Code: 10 seconds On, 5 seconds Off
- Two-Stage (depending on programming) and then changes to Temporal

4.18 Presignal

Presignal option programs an initiating device to delay the activation of NACs and/or control modules while allowing visual verification by a person. Once a detector or monitor module triggers an alarm, the onboard piezo sounds immediately, but the NACs are not activated for a user programmed time duration of up to three minutes. Note that the alarm relay and communicator will respond to the initial alarm immediately. In addition, Zone 98 will activate. This zone can be programmed to a control module which may be used to activate a sounder or indicator which the installer designates as a Presignal indication. *Do not assign Zone 98 to a Notification Appliance Circuit when using this zone to indicate a Pre-signal condition.*

After the programmed delay, the NACs will activate if the source of the alarm is not cleared. Note that if a second alarm occurs during the programmed time delay, the alarm will be processed immediately, causing activation of the appropriate output zones. The events which occur upon Presignal activation are as follows:

- ✓ onboard piezo sounds immediately
- ✓ control panel LCD display will indicate a presignal event and the active point
- ✓ control points programmed to Zone 98 will activate
- ✓ annunciators (if enabled) will sound the local piezo, and pulse the alarm LED and zone LED
- ✓ outputs (NACs and control modules) of associated zones will be inhibited from activating for a user programmed time delay of up to three minutes
- ✓ second alarm occurring anytime during the time delay will cause immediate activation of all associated outputs

Presignal does not affect monitor modules programmed as waterflow, supervisory, process monitoring or remote switches. *Presignal operation requires the approval of the local Authority Having Jurisdiction.*

4.19 Positive Alarm Sequence

PAS (Positive Alarm Sequence) option will program a smoke detector to delay panel activation (including alarm relay and communicator) for a period of 15 seconds. Zone 97, however, will activate immediately and may be used to connect a signaling device to indicate PAS activation. *Do not assign Zone 97 to a Notification Appliance Circuit when using this zone to indicate a PAS condition.*

When a detector triggers an alarm, the onboard piezo sounds immediately, but the NACs are prevented from activating for 15 seconds. This inhibit time is factory set and cannot be changed. Pressing the Alarm Silence or Acknowledge/Step key during the 15 second inhibit time will silence the piezo sounder and start a timer which prevents activation of NACs for an additional time duration which can be user programmed for up to three minutes. After the programmed delay, the NACs will activate if the source of the alarm is not cleared. Note that if a second alarm occurs during either time delay, the alarm will be processed immediately, causing activation of the appropriate output zones. The events which occur upon PAS activation are as follows:

- ✓ onboard piezo sounds immediately
- ✓ control panel LCD display will indicate a presignal event and the active point
- ✓ control points programmed to Zone 97 will activate
- ✓ ACS annunciators (if enabled) will pulse the Zone 97 PAS LED immediately upon PAS activation. They will sound the local piezo, and pulse the alarm, associated zone and detector address point LEDs after 15 seconds of an unacknowledged PAS activation. Note that if the Alarm Silence or Acknowledge/Step button is pressed, the annunciators will be inhibited from activating for an additional time delay
- ✓ outputs (NACs and control modules) of associated zones will be inhibited from activating for a factory set duration of 15 seconds
- ✓ pressing the Alarm Silence or Acknowledge/Step key will start a timer which inhibits output activation for additional time delay of up to three minutes which is user programmable
- ✓ second alarm occurring anytime during either time delay will cause immediate activation of all associated outputs

PAS operation requires the approval of the local Authority Having Jurisdiction.

Note that the *PAS BYPASS* monitor type code, when activated, will inhibit the PAS capability until the *PAS BYPASS* monitor is deactivated. While PAS is inhibited, signaling devices will immediately place the control panel into alarm. This feature may be employed by wiring a normally open device, such as a switch, to a monitor module which has been programmed for *PAS BYPASS*.

4.20 Special System Timers

4.20.1 Silence Inhibit Timer

This option, if selected, prevents the *Alarm Silence* key from functioning for 60 seconds following an alarm. A new alarm during the initial 60 second period will not cause the timer to restart with a new 60 seconds. *Silence Inhibit operation requires the approval of the local Authority Having Jurisdiction.*

4.20.2 Autosilence Timer

If Autosilence is selected, the notification appliances, programmed as silenceable, will automatically be silenced after a programmable duration of from 5 to 30 minutes. Pressing the *Drill* key will restart the timer. *Autosilence operation requires the approval of the local Authority Having Jurisdiction.*

4.20.3 Trouble Reminder

If selected, this feature causes a reminding 'beep' every 15 seconds during an alarm (after the *Alarm Silence* key is pressed) and every two minutes during a trouble condition (after the *Acknowledge/Step* or *Alarm Silence* key is pressed). The 'beeps' from the onboard piezo sounder will occur until the alarm or fault is cleared.

Note that if the trouble is not cleared within 24 hours, the piezo will resound, indicating that the trouble condition still exists.

4.20.4 Waterflow Retard Timer

If selected, this option will delay the activation of a waterflow type alarm for a programmable time duration from 1 to 90 seconds. This delay is in addition to any time delay inherent in the waterflow device. *This feature requires the approval of the local Authority Having Jurisdiction.*

4.20.5 Alarm Verification (None or One Minute)

If alarm verification is selected, an addressable smoke detector's alarm is ignored for a retard time of 13 seconds and the detector's alarm condition is automatically reset. There will be no alarm indication at the FACP during the Retard period. A confirmation period of 60 seconds follows, during which a subsequent alarm from the same detector will cause the panel to immediately activate the appropriate outputs and indicate the alarm condition at the FACP. If a different detector alarms any time during the first detector's verification period, the panel will immediately activate all appropriate outputs and indicate the alarm condition at the FACP. If no additional detector alarms occur within 73 seconds of the first alarm (13 second retard plus 60 second confirmation), the timer resets and the panel is ready to verify any new detector alarms which may occur. The following is a graphic representation of Alarm Verification.

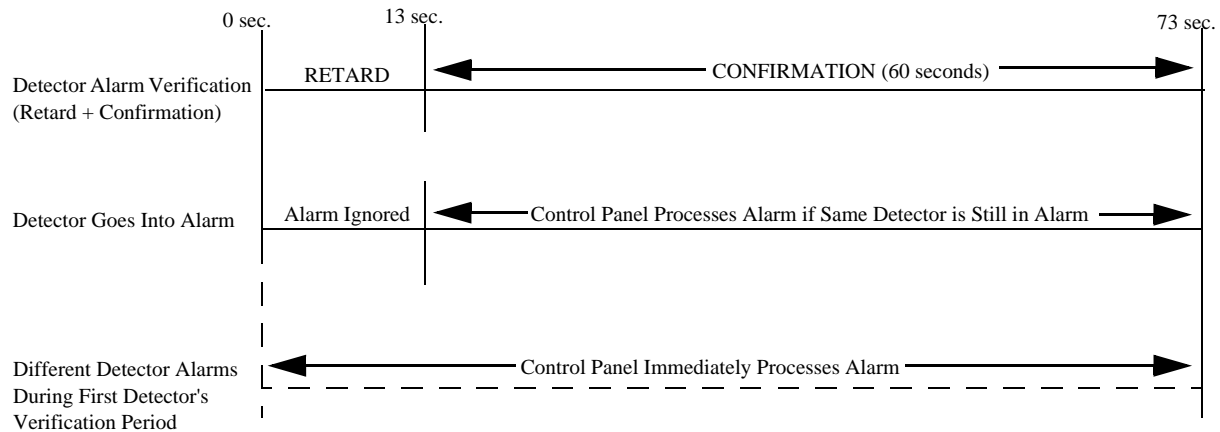

Note: Alarm Verification is available only for addressable smoke detectors, not conventional smoke detectors.

4.21 Walktest

Walktest is a feature which allows one person to test the fire alarm system. An audible walktest will momentarily sound the Notification Appliance Circuits in the building and store the walktest information in a file at the panel. A silent walktest will not sound the NACs but will store the walktest information in a file which can be viewed at the panel. Disabled NAC devices will not activate during walktest.

Alarm/Shorted Condition

When in audible Walktest, the panel responds to each new alarm and activates its programmed control outputs for four seconds, if those outputs have been programmed for silenceable activation. It also stores each alarm in the walktest history file which can be sent to an optional printer. The stored display will be the same as if the device actually activated except the colon (:) in the time stamp is replaced with an asterisk (*).

Note that if the system under test includes one or more enabled MMF-302 monitor modules, the following may apply:

If the MMF-302 monitor module is used for a supervised, 2-wire smoke zone, alarming any monitor module in the system will result in the activation of programmed control outputs for an additional eight seconds or less. This is caused by the temporary removal of 24 VDC resettable power from the MMF-302. The MMF-302 reports this loss of power as an open condition in addition to the alarm condition.

Open Condition

Addressable devices are monitored for fault conditions during Walktest mode. When a new trouble condition occurs, the FACP will activate all NACs and control modules programmed for Walktest and mapped to the faulty device, then shut them off after eight seconds.

While in Walktest, the trouble relay is activated and the system Trouble LED flashes (as in all of the Program and status change operations). The alarm relay is not activated.

4.22 Read Status

Read Status functions do not require a password. The control panel will continue to provide fire protection while in Read Status mode. This mode can be entered while the control panel is in alarm or trouble. If a new alarm or trouble occurs during these functions, the Read Status is exited to prevent confusion.

Read Status Entry

When the operator presses the control panel *Enter* key, the LCD will display the following:

```

1=READ STATUS MODE
2=PROGRAMMING MODE
3=REMOTE DOWNLOAD
    
```

Pressing *1*, while this screen is being displayed, will cause the control panel to enter the Read Status mode which allows the user to view and print the programmed features and status of the control panel.

The following screens will be displayed:

```

          READ STATUS
1=SYSTEM POINT
2=ZONES
3=POWER
    
```

Read Status Screen #1

```

          READ STATUS
1=ANNUNCIATORS
2=PHONE LINE
3=CENTRAL STATION
    
```

Read Status Screen #4

```

          READ STATUS
1=TROUBLE REMINDER
2=TIMERS
3=NACS
    
```

Read Status Screen #2

```

          READ STATUS
1=SERVICE TERMINAL
2=PRINTER/PC
3=PRINT
    
```

Read Status Screen #5

```

          READ STATUS
1=RELAYS
2=PROGRAM CHECK
3=HISTORY
    
```

Read Status Screen #3

```

          READ STATUS
1=TIME-DATE
    
```

Read Status Screen #6

4.22.1 System Point

```

READ STATUS
1=SYSTEM POINT
2=ZONES
3=POWER

```

Read Status Screen #1

Pressing *1* while viewing Read Status Screen #1 will cause the following screen to be displayed:

```

READ SYSTEM POINT
SELECT TYPE
1=DETECTOR
2=MODULE

```

The operator selects the type of device which is to be viewed by pressing *1* for Detector or *2* for Module. If *1* is pressed, the display will change to the following screen:

```

READ SYSTEM POINT
ENTER DETECTOR#
***

```

Entering the three digit detector address will cause the control panel to display the current status of the selected device. For example, if a detector with address *001* on the SLC loop is entered, a display similar to the following will appear:

```

NORMAL SMOKE(PHOTO)
NORTH CLASSROOM
                Z005
                U  1D001

```

The information in the preceding display includes:

- *NORMAL* - the present status (could also be ALARM, TROUBL, DISABL, etc.)
- *SMOKE (PHOTO)* - the device type which is a photoelectric smoke detector (could also be ION for ionization smoke detector)
- *NORTH CLASSROOM* - the Adjective/Noun label for this device
- *Z005* - the first of five possible assigned software zones
- *1D001* - *1* = SLC Loop, *D* = Detector, *001* = Address 001
- *V* - Alarm Verification Enabled (*V* = Yes, * = No)
- *S* - Silenceable for control modules (*S* = Yes, * = No)
- *W* - Walktestable for control and monitor modules (*W* = Yes, * = No)

Pressing the down arrow key, while viewing the screen shown above, will allow the operator to view additional programming information about the selected device, such as:

- Enable/Disable Status
- Device Type
- Alarm Verification On/Off (for detectors)
- Walktest Yes/No
- PAS (Positive Alarm Sequence) Yes/No (for detectors only)
- Pre-Signal Yes/No (for detectors and monitor modules)
- Zone Assignments (five maximum)
- Chamber Value
- Adjective/Noun descriptor
- Silenceable Yes/No (for control modules)

4.22.2 Zones

```

READ STATUS
1=SYSTEM POINT
2=ZONES
3=POWER
    
```

Read Status Screen #1

Pressing 2 while viewing Read Status Screen #1 will cause the following screens to be displayed:

```

                ZONES
1=ZONES INSTALLED
2=ZONES ENABLED
3=ZONES DISABLED
    
```

Zones Screen #1

```

                ZONES
1=SPECIAL PURPOSE
2=ZONE TYPE
3=ZONE MESSAGE
    
```

Zones Screen #2

From the preceding screens, the control panel operator can view:

- *Zones Installed* - all software zones programmed into the system (99 maximum)
- *Zones Enabled* - all software zones that are enabled
- *Zones Disabled* - all software zones that have been disabled
- *Special Purpose* - on or off programming for Special Purpose Zones 97 reserved for PAS, 98 reserved for Pre-signal and 99 reserved for Two Stage
- *Zone Type* - the Type assigned to each installed zone (default is Alarm)
- *Zone Message* - the Message assigned to each installed zone

4.22.3 Power

Pressing 3 while viewing Read Status Screen #1 will cause the following screens to be displayed:

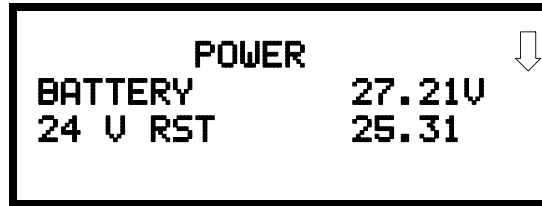

Power Screen #1

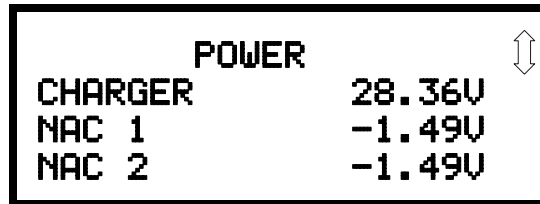

Power Screen #2



Power Screen #3

A real-time display of the control panel voltages can be used to determine if a problem exists in the system. *Note that **Power Screen #3** will only be displayed if the NACKEY NAC option card is installed, in JP8 of the main circuit board, for Class B operation.*

The following table lists the circuit being measured, possible conditions and their respective voltage ranges:

Circuit	Condition	Voltage Range
Battery	Normal Battery (nominal)	27.05 to 28.15 VDC
	Low Battery	20.0 to 20.8 VDC
	No Battery	0 to 18.36 VDC
24V Resettable	Normal	21.25 to 27.50 VDC
24V Nonresettable	Normal	21.25 to 27.50 VDC
Charger	Normal	21.87 to 29.84 VDC
NAC 1 or NAC 2	Normal	-1.3 to -1.6 VDC
	Open Circuit	-2.3 to -2.5 VDC
	Short Circuit	0 to 1.0 VDC

4.22.4 Trouble Reminder

READ STATUS
1=TROUBLE REMINDER
2=TIMERS
3=NAC

Read Status Screen #2

Pressing 1 while viewing Read Status Screen #2 will display the following screen:

```
      TROUBLE REMINDER
TROUBLE REM           ON
```

The screen indicates whether the Trouble Reminder feature is On or Off.

4.22.5 Timers

Pressing 2 while viewing Read Status Screen #2 will cause the following Timer screens to be displayed:

```
      TIMERS
PAS DELAY           000
PRE SIGNAL          000
WATERFLOW           000
```

```
      TIMERS
AC LOSS DELAY       4
```

These screens will indicate the delay time, in seconds, for each of the first three possible delay options. The AC Loss Delay time is displayed in hours.

4.22.6 NAC

Pressing 3 while viewing Read Status Screen #2 will display the following screen:

```

                NAC
1=NAC 1      3=NAC 3
2=NAC 2      4=NAC 4
  
```

Note that 3=NAC 3 and 4=NAC 4 will always be displayed regardless of how the NACKEY NAC option card is installed.

The operator can press 1 to view the programmed options for NAC 1, 2 to view the programmed options for NAC 2, 3 to view the programmed options for NAC 3 or 4 to view the programmed options for NAC 4. The resulting screens will display the following information:

- Enable/Disable Status
- Circuit Type (Bell, Strobe, etc.)
- Silenceable/Nonsilenceable
- Auto Silence Enable/Disable and time delay (in minutes)
- Coding Selection (Temporal, Steady, etc.)
- Zone Assignments
- Silence Inhibit Enabled/Disabled
- Synchronization Type (System Sensor, Wheelock or Gentex)

4.22.7 Relays

```

  READ STATUS
1=RELAYS
2=PROGRAM CHECK
3=HISTORY
  
```

Read Status Screen #3

Pressing 1 while viewing Read Status Screen #3 will display the following screen:

```

                RELAY
1=RELAY 1
2=RELAY 2
3=RELAY 3
  
```

The operator can view the programmed option for each relay by pressing the corresponding number key.

4.22.8 Program Check

Pressing 2 while viewing Read Status Screen #3 will cause a screen similar to the following to be displayed:

```

PROGRAM CHECK
1=NACS NO INPUT
2=ZONES NO INPUT
3=ZONES NO OUTPUT
    
```

Pressing 1 while viewing the Program Check screen will display a screen which will indicate if any input zones have not been programmed to one of the Notification Appliance Circuits. Use the up and down arrow keys to view all NACs.

Pressing 2 while viewing the Program Check screen will display a screen which will indicate if any output zones have not been programmed to at least one input zone. Use the up and down arrow keys to view all zones.

Pressing 3 while viewing the Program Check screen will display a screen which will indicate if any input zones have not been programmed to at least one output zone. Use the up and down arrow keys to view all zones.

4.22.9 History

Pressing 3 while viewing Read Status Screen #3 will display the following screen:

```

HISTORY
1=VIEW ALL
2=VIEW ALARMS
3=VIEW OTHER EVENTS
    
```

The operator can view all events which have been stored in the history file, only alarms or other events, such as troubles or supervisories, by pressing the corresponding number key.

4.22.10 Annunciators

```

READ STATUS
1=ANNUNCIATORS
2=PHONE LINE
3=CENTRAL STATION
    
```

Read Status Screen #4

Pressing 1 while viewing Read Status Screen #4 will display the following screens:

```

ANNUNCIATORS
TERM ENABLED      YES
2=ACS OPTIONS
3=ANN-BUS OPTIONS
    
```

Annunciator Screen

The Annunciator Screen indicates if Terminal mode options are enabled or disabled.

Pressing 2 for *ACS Options* while viewing the Annunciator Screen allows the operator to view the ACS Options screen:

ACS OPTIONS	
ACS ENABLED	NO
2=ACS ADDRESSES	
UDACT ENABLED	NO

ACS Options Screen

The ACS Options screen indicates if the ACS option has been enabled *YES* or disabled *NO*.

Pressing 2 for *ACS Addresses* while viewing the ACS Options screen will display screens with ACS addresses 1 -31 and whether a device is installed at that address *YES* or not installed *NO*.

The ACS Options screen indicates if a UDACT is installed *YES* or if a UDACT is not installed *NO*.

Pressing 3 for *ANN-BUS Options* while viewing the Annunciator Screen will display the following screens:

ANN-BUS	
ENABLED	NO
2=MODULES INSTALLED	
3=ANN-S/PG OPTIONS	

ANN-BUS Screen #1

ANN-BUS	
1=ANN-80 OPTIONS	

ANN-BUS Screen #2

The ANN-BUS Screen #1 indicates if the ANN-BUS has been enabled *YES* or disabled *NO*.

Pressing 2 for *Modules Installed* while viewing ANN-BUS Screen #1 will display screens for ANN-BUS Addresses 1 -8 and the devices installed at each address. Subscreen will display the options that have been programmed for each device.

Pressing 3 for *ANN-S/PG Options* while viewing ANN-BUS Screen #1 will display the options selected for the installed serial or parallel printer.

Pressing 1 for *ANN-80 Options* while viewing ANN-BUS Screen #2 will display the options selected for the installed ANN-80 annunciators.

4.22.11 Phone Line

Pressing 2 while viewing Read Status Screen #4 will display the following screen:

```
PHONE LINE
PRIMARY TOUCHTONE
SECONDARY TOUCHTONE
3=SUPERV PHONE LINE
```

The second and third lines of this screen indicate that both the Primary and Secondary phone lines have been configured for touchtone dialing operation.

Pressing 3 while viewing the Phone Line screen will cause the following screen to be displayed:

```
SUPERVISE PHONE LINE
PHONE LINE 2 NO
```

This screen indicates whether or not Phone Line 2 is being supervised. In this example, Phone Line 2 No indicates the phone line is not being supervised.

4.22.12 Central Station

```
READ STATUS
1=ANNUNCIATORS
2=PHONE LINE
3=CENTRAL STATION
```

Read Status Screen #4

Pressing 3 while viewing Read Status Screen #4 will display the following screens:

```
CENTRAL STATION
REPORTING ENABLED
REPORT BOTH
CALL LIMIT 10
```

Central Station Screen #1

```
CENTRAL STATION
1=PRIMARY
2=SECONDARY
3=REPORT STYLE
```

Central Station Screen #2

Central Station Screen #1 indicates whether the Central Station Reporting is enabled or disabled, if the Reports will be sent to one or both the Primary and Secondary Central Station phone numbers and the Call Limit for DACT trouble calls within a 24 hour period.

Central Station Screen #2 provides information on the Primary and Secondary Central Station programming which includes:

- Test Time Interval
- Account Code
- 24 Hour Test Time
- Phone Number
- Communication Format
- Event Codes

4.22.13 Service Terminal

READ STATUS
 1=SERVICE TERMINAL
 2=PRINTER/PC
 3=PRINT

Read Status Screen #5

Pressing 1 while viewing Read Status Screen #5 will display the following screens:

**SERVICE TERMINAL
RING COUNT**

Service Terminal Screen

The Panel ID number is displayed as the first item in Service Terminal Screen #1.

To view the phone number for each Service Terminal, press 2 for Terminal 1 or 3 for Terminal 2 while viewing Service Terminal Screen #1.

The Ring Count is displayed in Service Terminal Screen #2.

4.22.14 Printer/PC

Pressing 2 while viewing Read Status Screen #5 will display the following screen:

**PRINTER PC
PRINTER PC PR4800**

Printer/PC Screen

The display will inform the operator as to whether the control panel is configured for a printer or a PC. In the example above, PR4800 indicates that the panel is configured for a printer with a baud rate of 4,800.

4.22.15 Print

```

READ STATUS
1=FUTURE USE
2=PRINTER/PC
3=PRINT
    
```

Read Status Screen #5

To print program data or control panel status, press 3 while viewing Read Status Screen #5. The following screens will be displayed:

```

PRINT
1=HISTORY
2=WALKTEST LOG
3=DETECTOR DATA
    
```

Print Screen #1

```

PRINT
1=EXIT PRINTING
    
```

Print Screen #2

Pressing 1 while viewing Print Screen #1 allows the user to print the History file which will detail all of the system activities since the file was last cleared from memory.

Pressing 2 while viewing Print Screen #1 allows the user to print the Walktest log which will detail all of the system activations during walktest since the log was last cleared. Refer to "Walktest" on page 113 for additional information on the display.

Pressing 3 while viewing Print Screen #1 allows the user to print the detector data for each addressable smoke detector connected to the system. A printout, similar to the following example, will be generated if an optional printer is connected to the FACP.

DEVICE#	DEVICE TYPE	%DRIFT COMP	CHAMBER	TIME/DATE
1D001	SMOKE (PHOTO)	20	1281	12:01AM 01-08-2001
1D002	SMOKE (PHOTO)	20	1281	12:01AM 01-08-2001
1D003	SMOKE (PHOTO)	21	1259	12:01AM 01-08-2001
1D004	SMOKE (PHOTO)	20	1309	12:02AM 01-08-2001
1D005	SMOKE (PHOTO)	21	1281	12:02AM 01-08-2001
1D006	SMOKE (PHOTO)	20	1322	12:02AM 01-08-2001
1D007	SMOKE (PHOTO)	20	1280	12:02AM 01-08-2001
1D008	SMOKE (PHOTO)	20	1215	12:02AM 01-08-2001
1D009	SMOKE (PHOTO)	20	1310	12:02AM 01-08-2001

Chamber Value

The Chamber value should be within the indicated range for the following smoke detectors:

- SD350(T), D350P(R) and SD300(T) Addressable Photoelectric Smoke Detectors: **405 - 2100** (obscuration of 1.00%/ft to 3.66%/ft.)
- CP350 and CP300 Addressable Ionization Smoke Detectors: **750 - 2100** (obscuration of 0.50%/ft. to 1.44%/ft.)

If the addressable smoke detector's Chamber reading is not within the acceptable range, clean the detector and check the Chamber value again. If the reading is still not within the acceptable range, immediately replace the detector.

Drift Compensation

Drift compensation uses software algorithms that identify and compensate for long-term changes in the data readings from each addressable smoke detector. These long-term changes in detector data readings are typically caused by dirt and dust accumulation inside the smoke chamber. Drift compensation performs the following functions:

- Samples photoelectric smoke detectors every 6 seconds and ionization smoke detectors every 3 seconds
- Allows a smoke detector to retain its original ability to detect actual smoke and resist false alarms, even as dirt and dust accumulate
- Reduces maintenance requirements by allowing the control panel to automatically perform the periodic sensitivity measurements required by NFPA Standard 72

The FACP software also provides filters to remove transient noise signals, usually caused by electrical interference.

Maintenance Alert

The software determines when the drift compensation for a detector reaches an unacceptable level that can compromise detector performance. When a detector reaches an unacceptable level, the control panel indicates a maintenance alert. Table 4.1 summarizes the three levels of maintenance alert:

Maintenance Level	FACP Status Displays	Indicates
Low Chamber Value	INUREP	A hardware problem in the detector
Maintenance Alert	DIRTY1	Dust accumulation that is near but below the allowed limit. <i>DIRTY 1</i> indicates the need for maintenance before the performance of the detector is compromised
Maintenance Urgent	DIRTY2	Dust accumulation above the allowed limit.

Table 4.1 Maintenance Alert Levels

Figure 4.1 illustrates a graphic representation of the maintenance levels:

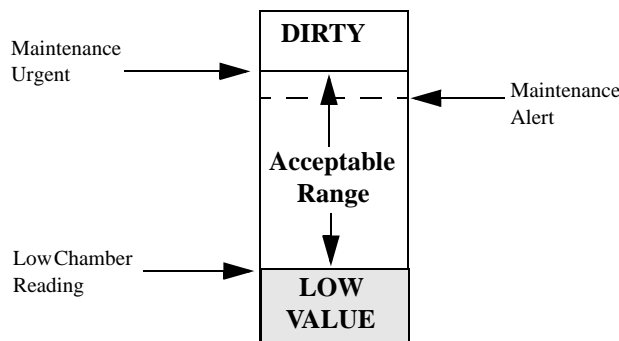

Figure 4.1 Diagram of Maintenance Levels

4.22.16 Time-Date

READ STATUS
1=TIME-DATE

The operator can view the daylight savings time and the month and week when daylight savings time will begin and end. Pressing 1 while viewing Read Status Screen #6 will display the following screens:

Read Status Screen #6

```
DAYLIGHT SAVINGS  ↓
ENABLED           YES
START MONTH      MAR
START WEEK       WEEK-2
```

```
DAYLIGHT SAVINGS  ↑
END MONTH        NOV
END WEEK         WEEK-1
```

SECTION 5**Central Station Communications**

The control panel transmits zone and system status reports to Central Stations via the public switched telephone network. Two supervised telephone line connections are made to interface the control panel to the telephone lines. Two optional 7 foot telephone cords are available for this purpose and can be purchased separately.

The control panel supervises both telephone lines for proper voltage. A delay of two minutes will occur before a fault in either phone line connection is reported as a trouble. When a fault is detected, an audible trouble signal will sound, the yellow trouble LED will blink, the LCD display will indicate the phone line trouble and the trouble condition will be reported to the Central Station over the remaining operational phone line.

The control panel comes with line seizure capability provided for both the primary and secondary telephone line interfaces. Any time that the control panel needs to make a call to a Central Station, line seizure will disconnect any local premises phones sharing the same telephone line.

All transmissions to the Central Stations will be sent over the primary phone line. In the event of noisy phone lines, transmissions will be sent over the backup secondary phone line.

Two phone numbers must be programmed, the primary Central Station phone number and the secondary Central Station phone number. All system reports will be transmitted to the primary Central Station phone number. Reports will automatically be sent to the secondary Central Station phone number if attempts to transmit to the primary Central Station phone number are unsuccessful. If 10 total attempts to communicate are unsuccessful, a Communicator Failure report will be displayed. Note that as an option, *all* reports may also be sent to the secondary Central Station phone number.

The MS-9200UDLS meets NFPA 72 National Fire Code reporting requirements for: (a) the type of signal, (b) condition and (c) location of the reporting premises. The general priority reporting structure is:

1. Zone Alarms and Restores
2. Zone Troubles and Restores
3. System Troubles and Restores
4. 24-hour Test

5.1 Transmittal Priorities

The integral communicator transmits highest priority events first. Events, in terms of priority, are listed below in descending order:

1. Alarms (highest priority level)
 - ✓ Pull stations
 - ✓ Waterflow
 - ✓ Smoke detector
 - ✓ Other alarm types
2. Supervisory Zone
3. System Troubles
 - ✓ Zone disabled
 - ✓ Fire drill
 - ✓ AC fail (after delay)
 - ✓ Zonal faults
 - ✓ Earth fault
 - ✓ Low battery
 - ✓ Telephone line fault
 - ✓ Notification Appliance Circuits fault
 - ✓ Communication trouble
 - ✓ Annunciator trouble
 - ✓ System off normal
4. Restoral Reports
 - ✓ Zone alarm
 - ✓ Supervisory
 - ✓ Zone(s) enabled
 - ✓ Fire drill
 - ✓ AC
 - ✓ Zone fault
 - ✓ Earth
 - ✓ Battery
 - ✓ Telephone line
 - ✓ Notification Appliance Circuits
 - ✓ Communication
 - ✓ Annunciator trouble
 - ✓ System off normal
5. 24 Hour Test (lowest priority)

Red LEDs are provided on the circuit board to identify which telephone line is activated. Also, a green LED labeled *Kissoff* will turn on whenever the control panel has successfully transmitted reports to the Central Station. The *Kissoff* LED may turn on several times during communications with a Central Station.

The table below shows UL listed receivers which are compatible with the MS-9200UDLS.

Table 5.1 Compatible UL Listed Receivers

Format	Ademco 685 (1)	Ademco MX8000 (2)	Silent Knight 9500 (3)	Silent Knight 9800 (4)	Osborne Hoffman 2000E (5)	Radionics 6600 (6)	SurGard MLR2 (7)	SurGard System III (8)	SurGard MLR-2000 (9)	FBI CP220FB (10)
0	SIA-DCS-8	✓	✓	✓	✓	✓		✓		✓
1	SIA-DCS-20		✓	✓	✓	✓		✓		✓
2	Ademco Contact ID	✓	✓	✓	✓	✓	✓	✓	✓	✓

1. With 685-8 Line Card with Rev. 4.4d software
2. With 124060V206B and 124063 Line Card Rev. B
3. With version V2.4 Receiver and 126047 Line Card Rev. G
4. With 124077V2.00 Receiver and 126047 Line Card Rev. M
5. With V.7301 Receiver S/W
6. With 01.01.03 Receiver S/W and Line Card 01.01.03
7. With software V1.86
8. With software V1.72
9. With DSP4016 and V1.6 Line Card
10. With software V3.9

IMPORTANT! It is the installer’s responsibility to ensure that the Digital Alarm Communicator/Transmitter is compatible with the Central Station Receiver, utilized by the monitoring service, prior to installation. The Compatibility Table provides a list of compatible receivers and associated software versions for the receivers. Changes in the hardware and/or software by the receiver manufacturers may affect the receiver compatibility with the FACP DACT. After completing the installation, communication between the DACT and Central Station Receiver must be tested and verified.

SECTION 6 Remote Site Upload/Download

Important! The FACP will automatically reset 2 minutes after completion of a user program download via the PS-Tools programming utility. To prevent program corruption, the operator must wait until this panel reset occurs before performing any panel operations.

The control panel may be programmed or interrogated off-site via the public switched telephone network or locally using a USB cable. Any personal computer with Windows™ XP or NEWER, with a 2400 baud compatible modem and Upload/Download software PS-Tools, may serve as a Service Terminal. This allows download of the entire program or upload of the entire program, history file, walktest data, current status, system voltages, time and date.

The control panel may also communicate to a local PC at the job-site. The PC must be connected to the USB connector J12 on the FACP main circuit board. A standard USB cable with male-A to male-B connectors, which must be purchased separately, is required.

Important: Remote modification of FACP programming requires that the panel be enabled for remote download (refer to "Remote Site Upload/Download" on page 184). Remote interrogation of panel programming, history logs, detector status, etc., is possible without enabling the remote download option.

CAUTION: After successfully downloading a program, make certain to perform the following steps:

1. Print out all programmed data via Print Mode or manually view programmed entries and compare to intended program data
2. Test all affected panel operations
3. Immediately correct any problems found

6.1 Remote Download

NFPA 72 requirements state that a technician be on-site and at the control panel whenever the PK-Plus Programming Utility is used to download any information to the FACP. This applies to local and remote programming. For this reason, a new option has been added to the FACP which allows an individual at the FACP to enter a password and either enable the proprietary mode where downloading will be allowed at any time or access a specific password protected screen where downloading will be allowed regardless of the current proprietary setting. The Remote Download option can be selected from the main menu screen as shown below:

```

1=READ STATUS MODE
2=PROGRAMMING MODE
3=REMOTE DOWNLOAD

```

Pressing 3 for Remote Download while viewing the main menu will cause the following screen to be displayed:

```

REMOTE DOWNLOAD
ENTER PASSWORD
*****

```

The Remote Download password (default 00000) must be entered to access the Remote Download feature. Note that the default password can be changed using the Password Change option (refer to "Password Change" on page 143). Entering the correct password will cause the following screen to be displayed:

```

REMOTE DOWNLOAD
1=PROPRIETARY      NO
2=ACCEPT DOWNLOAD
  
```

Pressing 1 for *Proprietary No* (factory default setting), while viewing the Remote Download screen, will cause the display to toggle from *Proprietary No* to *Proprietary Yes*. Each press of the 1 key will cause the display to toggle between *Proprietary No* and *Proprietary Yes*. Selecting *Proprietary Yes* will program the FACP to allow remote programming downloads from the PK-Plus programming utility at all times without the need to access the Remote Download screen.

Pressing 2 for *Accept Download* will cause the following screen to be displayed:

```

*ALLOWING DOWNLOADS*
  IF YOU EXIT THIS
  SCREEN DOWNLOADS
  WILL BE DISABLED!
  
```

While this screen is displayed, remote programming downloads are allowed regardless of the Proprietary setting. Exiting this screen will disable any further downloads to the FACP. Also, following 30 minutes of inactivity (including up/downloading), the Accept Download screen will time-out, causing the display to return to the System All Normal screen.

6.2 Transferring a Program

The first time that the control panel is downloaded (whether initiated at the jobsite or remotely), a secret code is loaded in by a Service Terminal. Future upload or download requests cause verification of the secret code by the control panel before processing of data is allowed. If the secret code is not verified, the control panel will terminate the request.

While the control panel is communicating with the Service Terminal, one of the DACT's red phone line active LEDs and the green *Kissoff* LED will turn on steady.

In order to download the panel (whether initiated at the jobsite or remotely), the following must be true:

- ✓ The control panel must be in the Normal Mode of operation. Downloading is not possible if the panel is in any other mode
- ✓ There cannot be any active communications ongoing with a Central Station receiver
- ✓ All active events must be successfully 'kissed-off' by the Central Station(s). The communicator must be in a standby state with no new information waiting to be transmitted to a Central Station

6.2.1 Security Features

Upload and download with the control panel have been carefully designed to include key security features to ensure proper functionality. Any time a transfer is initiated, the control panel and the Service Terminal will communicate and transfer data before contacting a Central Station. When the data transfers are completed and the control panel disconnects from the Service Terminal, the control panel will call the Central Station and report one of the following conditions:

- Upload/Download request received
- Upload and/or Download request successful
- Upload/Download failed

The key features are listed and explained in the following sections.

Secret Code Verification

A secret code is stored in the control panel by a Service Terminal to prevent unauthorized access. The secret code is created at the Service Terminal by the master user and cannot be viewed or changed by anyone other than a master user. Viewing of the secret code is prohibited at the control panel. Prior to allowing an upload or download of data, the control panel will verify the secret code transmitted by the Service Terminal.

Time-out at Control Panel

Upon answering an incoming call on either the primary or secondary Central Station phone line, the control panel will listen for a modem connection signal. If this signal is not received within 50 seconds, the control panel will disconnect the call. Upon successful connection (secret code verified), if no communication occurs within 30 minutes, the panel will disconnect the call. Upon time-out, transfer activity will be reported to the Central Station (if enabled) and the connection will be terminated.

Error Checking

As each block of data is received by the control panel, it is checked for accuracy. If an error is detected, the block is retransmitted until correct, up to a maximum of four times. If the Secret Code is not verified and four errors occur, the call is disconnected and the report that the upload/download was not successful is called to the Central Station(s).

Central Station Data Protection

The primary and secondary Central Station phone numbers, communications format, account code, test time and programmable event codes are vital Central Station information. These blocks of data are protected from partial programming due to faulty phone connections, line noise and other errors. This prevents the panel from being confused due to a wrong phone number, account code, test time and most critical formatting errors.

SECTION 7

Power Supply Calculations

7.1 Overview

This section contains instructions and tables for calculating power supply currents in alarm and standby conditions. This is a four-step process, consisting of the following:

1. Calculating the total amount of AC branch circuit current required to operate the system
2. Calculating the power supply load current for non-fire and fire alarm conditions and calculating the secondary (battery) load
3. Calculating the size of batteries required to support the system if an AC power loss occurs
4. Selecting the proper batteries for your system

7.2 Calculating the AC Branch Circuit

The control panel requires connection to a separate, dedicated AC branch circuit, which must be labeled **FIRE ALARM**. This branch circuit must connect to the line side of the main power feed of the protected premises. No other non-fire alarm equipment may be powered from the fire alarm branch circuit. The branch circuit wire must run

continuously, without any disconnect devices, from the power source to the control panel.

Overcurrent protection for this circuit must comply with Article 760 of the National Electrical Codes as well as local codes. Use 14 AWG (2.00 mm²) wire with 600 volt insulation for this branch circuit.

Use Table 7.1, to determine the total amount of current, in AC amperes (A), that must be supplied to the system.

Table 7.1 AC Branch Circuit Requirements

Device Type	Number of Devices		Current Draw (AC amps)		Total Current per Device
MS-9200UDLS or MS-9200UDLSE	1	X	3.00 or 1.50	=	
CHG-75	[]	X	2.05	=	
CHG-120F	[]	X	2.00	=	
	[]	X	[]	=	
Sum Column for AC Branch Current Required				=	

7.3 Calculating the System Current Draw

7.3.1 Overview

The control panel must be able to power all internal and external devices continuously during the non-fire alarm condition. To calculate the non-fire alarm load on the system power supply when primary power is applied, use Calculation Column 1 in Table 7.3 on page 189. The control panel must support a larger load current during a fire alarm condition. To calculate the fire alarm load on the power supply, use Calculation Column 2 in Table 7.3 on page 189. The secondary power source (batteries) must be able to power the system during a primary power loss. To calculate the non-fire alarm load on the secondary power source, use Calculation Column 3 in Table 7.3 on page 189.

When calculating current draw and the battery size, note the following:

- ‘Primary’ refers to the main power source for the control panel
- ‘Secondary’ refers to the control panel’s backup batteries
- All currents are given in amperes (A). Table 7.2 shows how to convert milliamperes and microamperes to full amperes.

Table 7.2 Converting to Full Amperes

To convert...	Multiply	Example
Milliamperes (mA) to amperes (A)	mA x 0.001	3 mA x 0.001 = 0.003A
Microamperes (μA) to amperes (A)	μA x 0.000001	300 μA x 0.000001 = 0.0003 A

7.3.2 How to Use Table 7.3 on page 189 to Calculate System Current Draw

Use Table 7.3 on page 189 to calculate current draws as follows:

1. Enter the quantity of devices in all three columns
2. Enter the current draw where required. Refer to the Device Compatibility Document for compatible devices and their current draw
3. Calculate the current draws for each in all columns
4. Sum the total current for each column
5. Copy the totals from Column 2 and Column 3 to Table 7.4 on page 190

Following are the types of current that can be entered into Table 7.3 on page 189:

- ✓ **Calculation Column 1** - The primary supply current load that the control panel must support during a non-fire alarm condition, with AC power applied.
- ✓ **Calculation Column 2** - The primary supply current load that the control panel must support during a fire alarm condition, with AC power applied.
- ✓ **Calculation Column 3** - The standby current drawn from the batteries in a non-fire alarm condition during a loss of AC power.

Table 7.3 contains columns for calculating current draws. For each column, calculate the current and enter the total (in amperes) in the bottom row. When finished, copy the totals from Calculation Column 2 and Calculation Column 3 to Table 7.4 on page 190.

Table 7.3 System Current Draw Calculations

Device Type	Calculation Column 1 Primary, Non-Fire Alarm Current (amps)			Calculation Column 2 Primary, Fire Alarm Current (amps)			Calculation Column 3 Secondary, Non-Fire Alarm Current (amps)		
	Qty	X[current draw]=	Total	Qty	X [current draw] =	Total	Qty	X[current draw]=	Total
Main Circuit Board	[]	X[0.340]=	0.340	[]	X[0.360]=	0.360	[]	X[0.137]=	0.137
ANN-80	[]	X[0.037]=		[]	X[0.040]=		[]	X[0.015]=	
ANN-LED	[]	X[0.028]=		[]	X[0.068]=		[]	X[0.028]=	
ANN-RLY	[]	X[0.015]=		[]	X[0.075]=		[]	X[0.015]=	
ANN-I/O	[]	X[0.035]=		[]	X[0.200]=		[]	X[0.035]=	
ANN-S/PG	[]	X[0.045]=		[]	X[0.045]=		[]	X[0.045]=	
ACM-8RF	[]	X[0.030]=		[]	X[0.158] ¹ =		[]	X[0.030]=	
ACM-16ATF	[]	X[0.040]=		[]	X[0.056] ² =		[]	X[0.040]=	
ACM-32AF	[]	X[0.040]=		[]	X[0.056] ² =		[]	X[0.040]=	
AEM-16ATF	[]	X[0.002]=		[]	X[0.018] ² =		[]	X[0.002]=	
AEM-32AF	[]	X[0.002]=		[]	X[0.018] ² =		[]	X[0.002]=	
AFM-16ATF	[]	X[0.040]=		[]	X[0.056] ² =		[]	X[0.040]=	
AFM-32AF	[]	X[0.040]=		[]	X[0.056] ² =		[]	X[0.040]=	
AFM-16AF	[]	X[0.025]=		[]	X[0.065] ² =		[]	X[0.025]=	
LDM-32F	[]	X[0.040]=		[]	X[0.056] ³ =		[]	X[0.040]=	
LDM-E32F	[]	X[0.002]=		[]	X[0.018]=		[]	X[0.002]=	
LCD-80F	[]	X[0.064]=		[]	X[0.064]=		[]	X[0.025]=	
4XTMF	[]	X[0.005]=		[]	X[0.011] ⁴ =		[]	X[0.005]=	
4-wire Detector Heads	[]	X[] ⁵ =		[]	X[]=		[]	X[]=	
Power Supervision Relays ⁶	[]	X[0.025]=		[]	X[0.025]=		[]	X[0.025]=	
CP350 & CP355	[]	X[0.00030]=		maximum alarm draw for all devices	0.400	[]	X[0.00030]=		
SD350 & SD355	[]	X[0.00030]=	[]			X[0.00030]=			
SD350T & SD355T	[]	X[0.00030]=	[]			X[0.00030]=			
AD350 & AD355	[]	X[0.00030]=	[]			X[0.00030]=			
H350 & H355	[]	X[0.00030]=	[]			X[0.00030]=			
H350R & H355R	[]	X[0.00030]=	[]			X[0.00030]=			
H355HT	[]	X[0.00030]=	[]			X[0.00030]=			
D350P & D350PL	[]	X[0.00030]=	[]			X[0.00030]=			
D350RP & D350RPL	[]	X[0.00030]=	[]			X[0.00030]=			
B501BH & B501BHT ⁷	[]	X[0.001]=	[]			X[0.001]=			
B224RB Relay Base	[]	X[0.00050]=	[]			X[0.00050]=			
B224BI Isolator Base	[]	X[0.00045]=	[]			X[0.00045]=			
MMF-300	[]	X[0.00040]=	[]			X[0.00040]=			
MMF-300-10	[]	X[0.00350]=	[]			X[0.00350]=			
MDF-300	[]	X[0.00075]=	[]	X[0.00075]=					
MMF-301	[]	X[0.000375]=	[]	X[0.000375]=					
MMF-302	[]	X[0.00027]=	[]	X[0.00027]=					
MMF-302-6	[]	X[0.00200]=	[]	X[0.00200]=					
BG-12LX	[]	X[0.00030]=	[]	X[0.00030]=					
CMF-300	[]	X[0.00039]=	[]	X[0.00039]=					
CMF-300-6	[]	X[0.00225]=	[]	X[0.00225]=					
CRF-300	[]	X[0.00027]=	[]	X[0.00027]=					
CRF-300-6	[]	X[0.00145]=	[]	X[0.00145]=					
I300	[]	X[0.00040]=	[]	X[0.00040]=					
NAC #1 ⁸	[]	X[]=	[]	X[]=					
NAC #2	[]	X[]=	[]	X[]=					
NAC #3	[]	X[]=	[]	X[]=					
NAC #4	[]	X[]=	[]	X[]=					
Current Draw from TB3 (nonalarm ⁹)	[]	X[]=	[]	X[]=					
Sum each column¹⁰ for totals	Primary Non-Alarm =		Primary Alarm =		Secondary Non-Alarm =				

Table Footnote

1. All eight ACM-8RF relays activated on a single module.
2. All annunciator LEDs on
3. LDM-32F with LEDs on
4. If using the Reverse Polarity Alarm output, add 0.005 amps; if using the Reverse Polarity Trouble output, add another 0.005 amps.
5. Refer to the Device Compatibility Document for standby current.
6. Must use compatible listed Power Supervision Relay.
7. Maximum alarm current for each sounder base is 0.015 amps which must be supplied by aux. 24VDC source.
8. Current limitation of Terminal TB3 & TB4 circuits is 2.5 amps per NAC.
9. The total standby current must include both the nonresettable/resettable (TB1 Terminals 1 & 2) and resettable (TB1 Terminals 3 & 4) power. Caution must be taken to ensure that current drawn from these outputs during alarm does not exceed maximum ratings specified. Current limitations of TB3 & TB4 circuits is 2.5 amps per NAC output and 0.3 amps per special application auxiliary power output
10. Total current draw listed above cannot exceed 6.0 amps.

7.4 Calculating the Battery Size

Use Table 7.4 to calculate the total Standby and Alarm load in ampere hours (AH). This total load determines the battery size (in AH), required to support the control panel under the loss of AC power. Complete Table 7.4 as follows:

1. Enter the totals from Table 7.3 on page 189, Calculation Columns 2 and 3 where shown
2. Enter the NFPA Standby and Alarm times (refer to 'NFPA Requirements' below)
3. Calculate the ampere hours for Standby and Alarm, then sum the Standby and Alarm ampere hours
4. Multiply the sum by the derating factor of 1.2 to calculate the proper battery size (in AH)
5. Write the ampere hour requirements on the Protected Premises label located inside the cabinet door

Table 7.4 Total Secondary Power Requirements at 24 VDC

Secondary Standby Load (total from Table 7.3 Calculation Column 3) []	Required Standby Time (24 hours) X[]	= AH
Primary Alarm Load (total from Table 7.3 Calculation Column 2) []	Required Alarm Time (for 5 min., enter 0.084, for 10 min., enter 0.168) X[]	= AH
Sum of Standby and Alarm Ampere Hours		= AH
Multiply by the Derating Factor		X 1.2
Battery Size, Total Ampere Hours Required		= AH

7.4.1 NFPA Battery Requirements

- NFPA 72 Local, Proprietary, Central, Auxiliary and Remote Fire Alarm Systems require 24 hours of standby power followed by 5 minutes in alarm

7.4.2 Selecting and Locating Batteries

Select batteries that meet or exceed the total ampere hours calculated in Table 7.4. The control panel can charge batteries in the 7 AH to 18 AH range. The control panel cabinet is capable of housing batteries up to 18 AH. Batteries larger than 18 AH require a UL listed external battery charger and cabinet such as the BB-26, BB-55F or other UL listed external battery cabinet.

APPENDIX A **Software Zones**

A.1 Correlations

Setup and configuration of an addressable system is different than a conventional system. In a conventional system, assignment of input devices (smoke detectors, pull stations, heat detectors, etc.) to zones is accomplished through wiring. The wiring is direct from clearly marked panel terminals to any device assigned to a particular zone. Connection of output devices (horns, bells, strobes, etc.) in a conventional system is accomplished by direct wiring of the output devices to Notification Appliance Circuit terminals.

In an addressable system, a minimum of a single pair of wires (SLC communication loop) is used to connect all addressable input and output devices. Communications between the FACP (Fire Alarm Control Panel) and all addressable devices takes place over the wire pair which originates from the FACP. Software programming is used to configure the system as opposed to direct wiring. Zone assignments are created via software means, hence the term *software zones*.

Setup of an MS-9200UDLS software zone is accomplished by panel programming. Each addressable device can be assigned to a maximum of five software zones. Each software zone, however, may have from 1 to 99 addressable input devices assigned to it and from 1 to 99 addressable output devices assigned to it.

Monitor and control modules comprise one group of 99 addresses, with each module having a unique address from 1 to 99. Detectors comprise a separate group of 99 addresses, each detector having a unique address from 1 to 99 in its group. Be careful not to duplicate addresses within any one group (modules and detectors). Refer to the following page for an example of zoning.

In the example on the following page:

- Zone 01 has the following addressable devices assigned to it:
 - ✓ SD350 smoke detectors with addresses *01* and *02*
 - ✓ MMF-300 monitor module with address *01*
 - ✓ MMF-302 monitor module with address *02* and *03*
 - ✓ CMF-300 control modules with addresses *05*, *06*, *07*, *09* and *13*
- Zone 02 has the following addressable devices assigned to it:
 - ✓ MMF-302 monitor module with addresses *02* and *03*
 - ✓ CP350 smoke detectors with addresses *03* and *04*
 - ✓ CMF-300 control modules with addresses *08*, *09* and *10*
- Zone 03 has the following addressable devices assigned to it:
 - ✓ SD350 smoke detectors with addresses *05*, *06* and *07*
 - ✓ MMF-302 control module with address *04*
 - ✓ CMF-300 control modules with addresses *09*, *11* and *12*

The example points out some of the key assignment features of the MS-9200UDLS. Addresses of detectors are not duplicated. Addresses of monitor and control modules are not duplicated. The control module with address 09 is assigned to three software zones (providing floor above and floor below). Be careful to properly plan the installation prior to installing any devices.

Correlation of Input and Output Zones

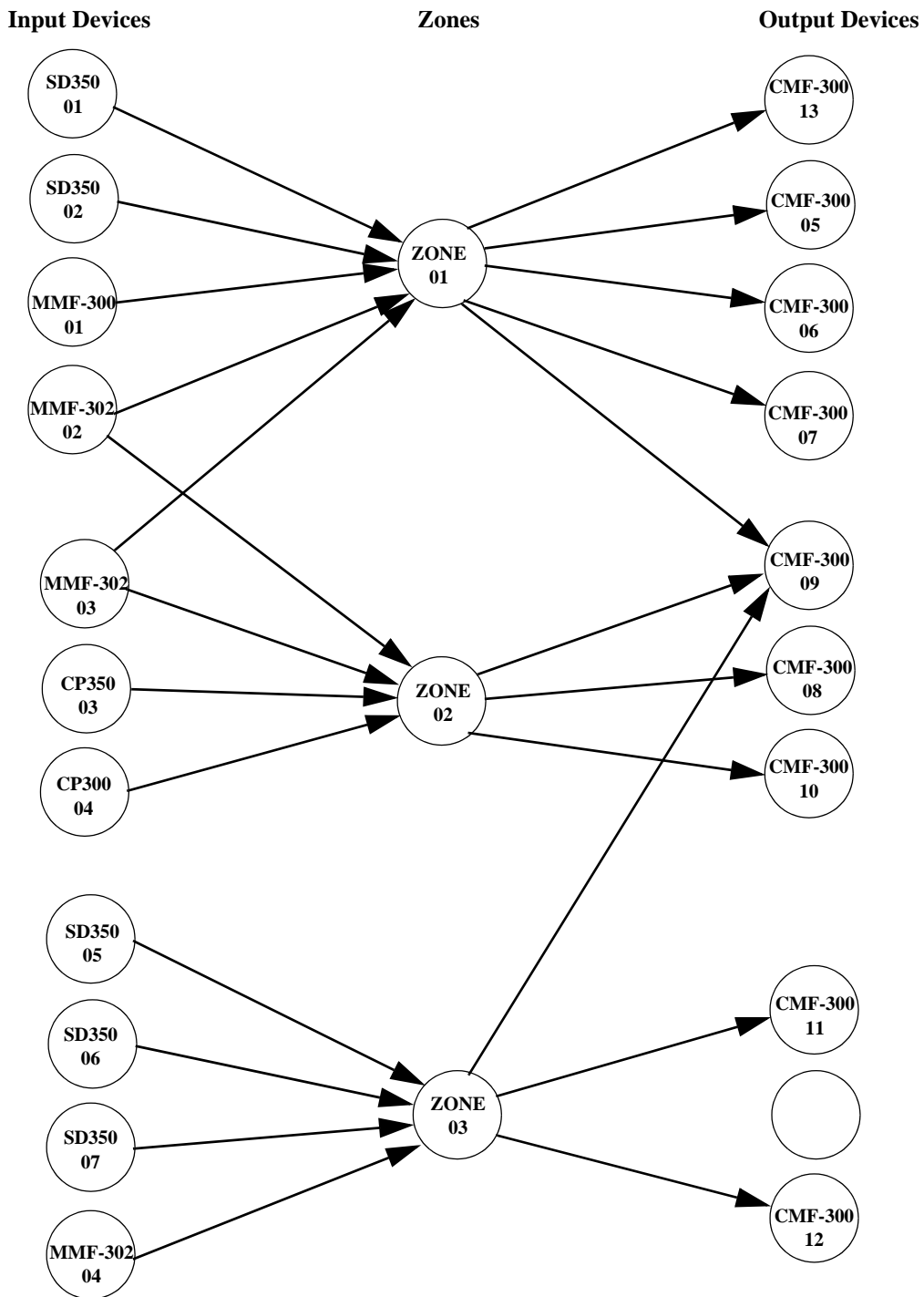

The zone correlations which are shown graphically above are also presented in Table A.1 on page 193 and Table A.2 on page 194.

Table A.1 Detector Programming Sheet Example

DETECTOR ZONE ASSIGNMENT							
Address	Device Type	Zone Number	ADJ/NOUN	Address	Device Type	Zone Number	ADJ/NOUN
01	SD350	1	FIRST HALL	51			
02	SD350	1	ELEV. LOBBY	52			
03	CP350	2	2ND FLOOR	53			
04	CP350	2	ROOM 210	54			
05	SD350	3	3RD FLOOR	55			
06	SD350	3	MEZZANINE	56			
07	SD350	3	MECH. ROOM	57			
08				58			
09				59			
10				60			
11				61			
12				62			
13				63			
14				64			
15				65			
16				66			
17				67			
18				68			
19				69			
20				70			
21				71			
22				72			
23				73			
24				74			
25				75			
26				76			
27				77			
28				78			
29				79			
30				80			
31				81			
32				82			
33				83			
34				84			
35				85			
36				86			
37				87			
38				88			
39				89			
40				90			
41				91			
42				92			
43				93			
44				94			
45				95			
46				96			
47				97			
48				98			
49				99			
50							

Table A.2 Module Programming Sheet Example

MONITOR/CONTROL MODULE ZONE ASSIGNMENT							
Address	Device Type	Zone Number	ADJ/NOUN	Address	Device Type	Zone Number	ADJ/NOUN
01	MMF-300	1		51			
02	MMF-302	1, 2		52			
03	MMF-302	1, 2		53			
04	MMF-302	3		54			
05	CMF-300	1		55			
06	CMF-300	1		56			
07	CMF-300	1		57			
08	CMF-300	2		58			
09	CMF-300	1, 2, 3		59			
10	CMF-300	2		60			
11	CMF-300	3		61			
12	CMF-300	3		62			
13	CMF-300	1		63			
14				64			
15				65			
16				66			
17				67			
18				68			
19				69			
20				70			
21				71			
22				72			
23				73			
24				74			
25				75			
26				76			
27				77			
28				78			
29				79			
30				80			
31				81			
32				82			
33				83			
34				84			
35				85			
36				86			
37				87			
38				88			
39				89			
40				90			
41				91			
42				92			
43				93			
44				94			
45				95			
46				96			
47				97			
48				98			
49				99			
50							

Table A.3 Blank Detector Programming Sheet - 1 of 2

DETECTOR ZONE ASSIGNMENT							
Address	Device Type	Zone Number	ADJ/NOUN	Address	Device Type	Zone Number	ADJ/NOUN
01				51			
02				52			
03				53			
04				54			
05				55			
06				56			
07				57			
08				58			
09				59			
10				60			
11				61			
12				62			
13				63			
14				64			
15				65			
16				66			
17				67			
18				68			
19				69			
20				70			
21				71			
22				72			
23				73			
24				74			
25				75			
26				76			
27				77			
28				78			
29				79			
30				80			
31				81			
32				82			
33				83			
34				84			
35				85			
36				86			
37				87			
38				88			
39				89			
40				90			
41				91			
42				92			
43				93			
44				94			
45				95			
46				96			
47				97			
48				98			
49				99			
50							

Table A.4 Blank Module Programming Sheet - 1 of 2

MONITOR/CONTROL MODULE ZONE ASSIGNMENT							
Address	Device Type	Zone Number	ADJ/NOUN	Address	Device Type	Zone Number	ADJ/NOUN
01				51			
02				52			
03				53			
04				54			
05				55			
06				56			
07				57			
08				58			
09				59			
10				60			
11				61			
12				62			
13				63			
14				64			
15				65			
16				66			
17				67			
18				68			
19				69			
20				70			
21				71			
22				72			
23				73			
24				74			
25				75			
26				76			
27				77			
28				78			
29				79			
30				80			
31				81			
32				82			
33				83			
34				84			
35				85			
36				86			
37				87			
38				88			
39				89			
40				90			
41				91			
42				92			
43				93			
44				94			
45				95			
46				96			
47				97			
48				98			
49				99			
50							

APPENDIX B Default Programming

The following table provides a list of the programming options and their factory default settings.

Program Option	Factory Default	Program Option	Factory Default
Detector Programming	Not Installed	Relay 1	Alarm
Detector Type	Smoke-Photo	Relay 2	Trouble (fixed)
Detector Verification	Off	Relay 3	Supervisory
Detector Walktest	Yes	Annunciator Terminal Mode	No
Detector PAS	No	Annunciator ACS Mode	No
Detector Presignal	No	UDACT	No
Detector Zone Assign.	000 only	ACS Installed	No
Detector Adj/Noun	none	Onboard DACT	No
Module Programming	Not Installed	Printer-PC	No
Module Type	Monitor	Printer Baud	9600
Module Walktest	Yes	Service Terminal Panel ID	0000
(not used)		Ring Count	0
Module Presignal	No	Primary Phone Type	Touchtone
Module Zone Assign.	000 only	Secondary Phone Type	Touchtone
Module Adj/Noun	none	DACT Communication	OFF
Zone 0 Enable	Enabled	AC Loss Delay	2
Zone 1 Enable	Enabled	Backup Reporting	First Available
Zone 2 Enable	Enabled	Primary Reporting Style	Report Point
Zone 3 Enable	Enabled	Secondary Reporting Style	Report Point
.....through.....	Primary Account Code	0000
Zone 96 Enable	Enabled	Secondary Account Code	0000
Zones 97, 98 & 99	Enabled	Primary 24 Hour Test Time	0100
(future)		Secondary 24 Hour Test Time	0200
Loop Style	Style 4	Primary Phone Number	
Loop Protocol	LITESPEED	Secondary Phone Number	
Trouble Reminder	Off	Primary DACT Format	Ademco Contact ID
Banner		Secondary DACT Format	Ademco Contact ID
Time Format	12 Hr	ANN Enabled	No
Hours Setting	12	ANN-BUS Modules Addr. 1 - 8	None
Minutes Setting	00	ANN-S/PG Port	Parallel
Second Settings		ANN-S/PG Baud	9600
AM-PM Setting	AM	ANN-S/PG Data Bits	7
Month Setting	01	ANN-S/PG Parity	Even
Day Setting	01	ANN-S/PG Stop Bits	1
Year Setting	00	ANN-S/PG Offline Timer	60
Daylight Savings	Enabled	ANN-S/PG Printer Supervision	No
Month Start Daylight Savings	March	ANN-80 Piezo Enabled	Yes
Week Start Daylight Savings	Week 2	ANN-80 Lock Enabled	Yes
Month End Daylight Savings	November	ANN-80 Acknowledge Button Enabled	Yes
Week End Daylight Savings	Week 1	ANN-80 Silence Button Enabled	Yes
Verification	OFF	ANN-80 Reset Button Enabled	Yes
PAS Timer	0	ANN-80 Drill Button Enabled	Yes
Presignal Timer	0	ANN-I/O Point/Zone	Zone
Waterflow Retard Timer	0	ANN-I/O Range	00-29
NAC 1, 2, 3 & 4 Enable	Enabled	ANN-I/O Active LEDs Only	
NAC 1, 2, 3 & 4 Silenceable	Yes	ANN-RLY Relay 1	Zone 1
NAC 1, 2, 3 & 4 Type	Bellthrough.....
NAC 1, 2, 3 & 4 Sync Type	System Sensor	ANN-RLY Relay 10	Zone 10
NAC 1, 2, 3 & 4 Autosilence	0	ANN-LED Point/Zone	Zone
NAC 1, 2, 3 & 4 Coding	Steady	ANN-LED Alarms/ATS (Alarm, Trbl, Supv)	ATS
NAC 1, 2, 3 & 4 Zones	Zone 000 only	ANN-LED Range	0 - 9
NAC 1, 2, 3 & 4 Silence Inhibit	No		

APPENDIX C

NFPA Standard-Specific Requirements

The MS-9200UDLS has been designed for use in commercial, industrial and institutional applications and meets the requirements for service under the National Fire Protection Association (NFPA) Standards outlined in this Appendix. The minimum system components required for compliance with the appropriate NFPA standard are listed below:

MS-9200UDLS Control Panel

Contains the main control board, cabinet (backbox and door), main power supply transformer and power supply.

Batteries

Refer to "Power Supply Calculations" on page 187, for Standby Power Requirements.

Initiating Devices

Connected to one of the control panel's Initiating Device Circuits.

Notification Appliances

Connected to the control panel's Notification Appliance Circuits via a control module.

The following additional equipment is needed for compliance with the NFPA 72 standards listed below:

NFPA 72 NATIONAL FIRE ALARM STANDARDS FOR:

NFPA 72 Central Station Service (Protected Premises Unit) or Remote Station Service

Onboard Digital Alarm Communicator Transmitter for connection to a compatible listed Central Station DACR or Protected Premises Receiving Unit. This unit must be installed as outlined in "Digital Alarm Communicator/Transmitter" on page 19.

OR

4XTMF Transmitter Module for connection to the RS82 Remote Station Receiver. See Figure C.2, "Remote Station Connection Using 4XTMF Module," on page 200, for installation instructions for this unit.

NFPA 72 Auxiliary Fire Alarm System

F Transmitter Module for connection to a compatible listed Local Energy Municipal Box. This unit must be installed as illustrated in the section titled "4XTMF Transmitter Module Installation" on page 56 and as outlined in Figure C.1, "Municipal Box Connected to F Transmitter Module," on page 199.

NFPA 72 Proprietary Fire Alarm System

MS-9200UDLS Alarm, Trouble and Supervisory contacts connected to Transmitter(s). See Figure C.3, "Proprietary Protective Signaling System," on page 201, for installation instructions for this unit.

NFPA 72 Auxiliary Fire Alarm System

All connections are power-limited and supervised. This application is not suitable for separate transmission of sprinkler supervisory or trouble conditions.

Notes:

1. 3 ohms maximum loop resistance allowed for wiring from control panel to Municipal Box.
2. Cut JP3 on the MS-9200UDLS main circuit board to supervise placement of 4XTMF module and circuit.
3. Cut JP2 on the MS-9200UDLS main circuit board to enable FACP Supervisory relay.
4. Refer to "4XTMF Transmitter Module Installation" on page 56 for detailed information.

Figure C.1 Municipal Box Connected to F Transmitter Module

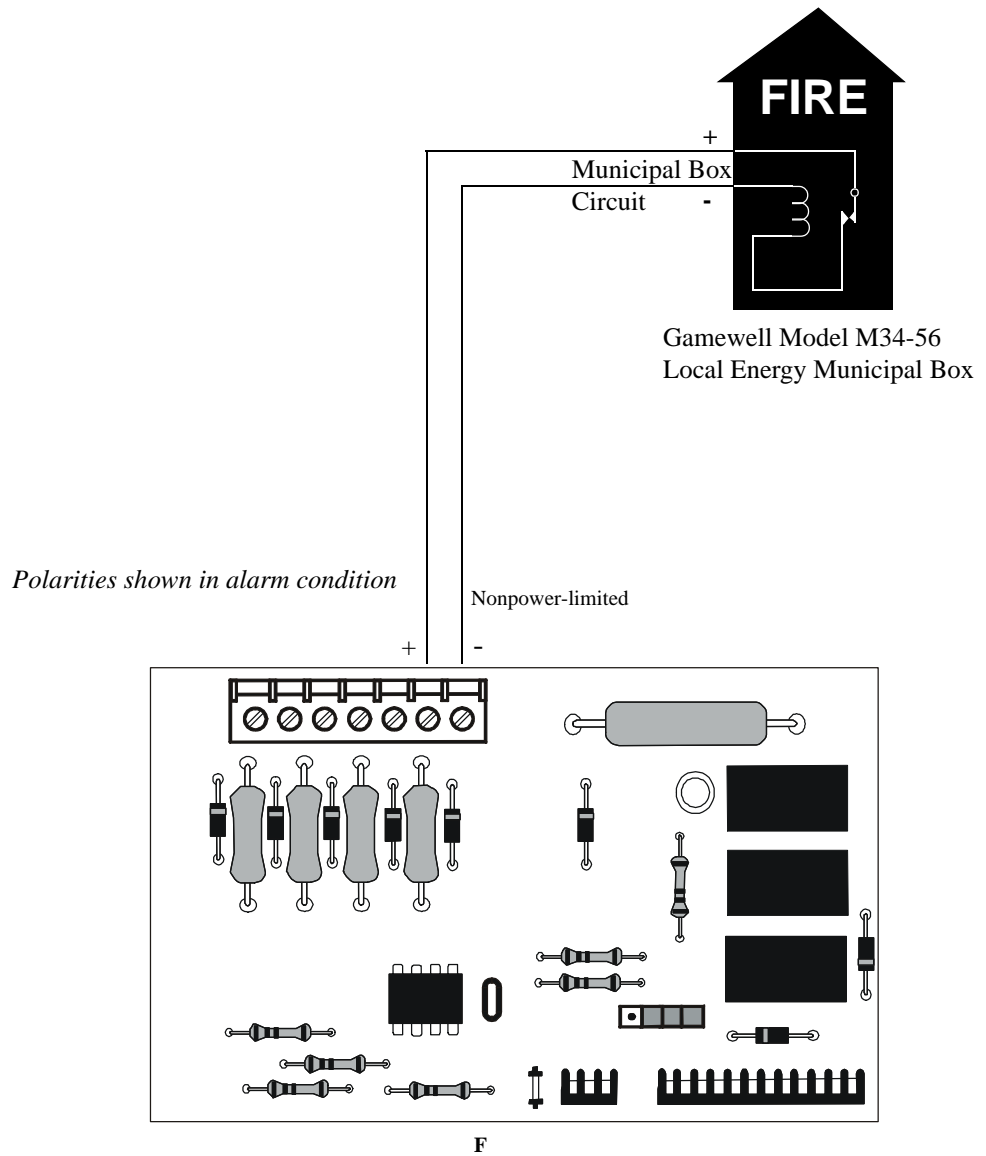

Figure C.1 Municipal Box Connected to 4XTMF Transmitter Module

NFPA 72 Remote Station Protective Signaling System

Notes:

1. Cut Jumper JP3 on the MS-9200UDLS main circuit board to supervise placement of the 4XTMF module.
2. Refer to "4XTMF Transmitter Module Installation" on page 56 for detailed information.

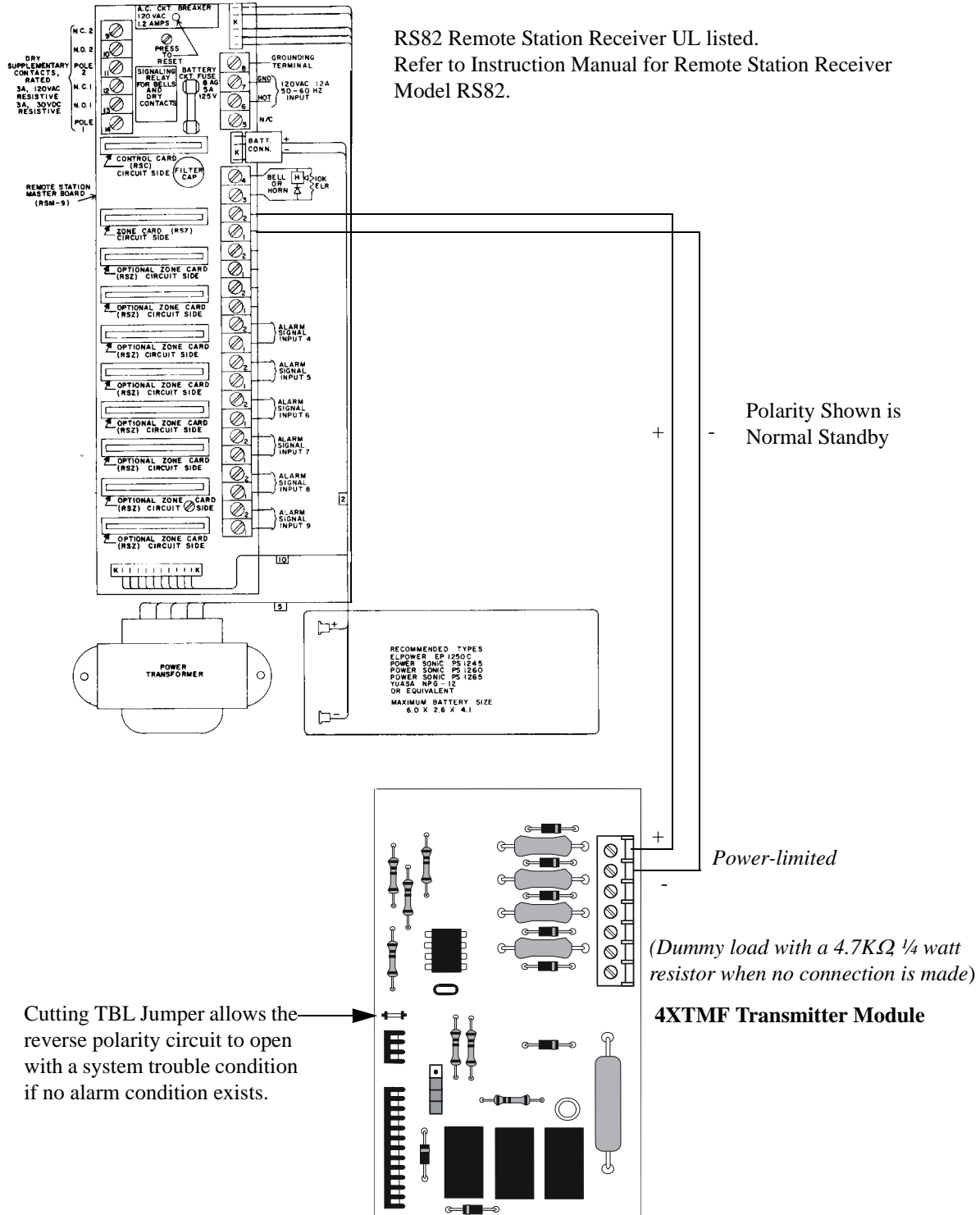

Figure C.2 Remote Station Connection Using 4XTMF Module

NFPA 72 Proprietary Protective Signaling Systems

MS-9200UDLS Addressable Fire Control Panel

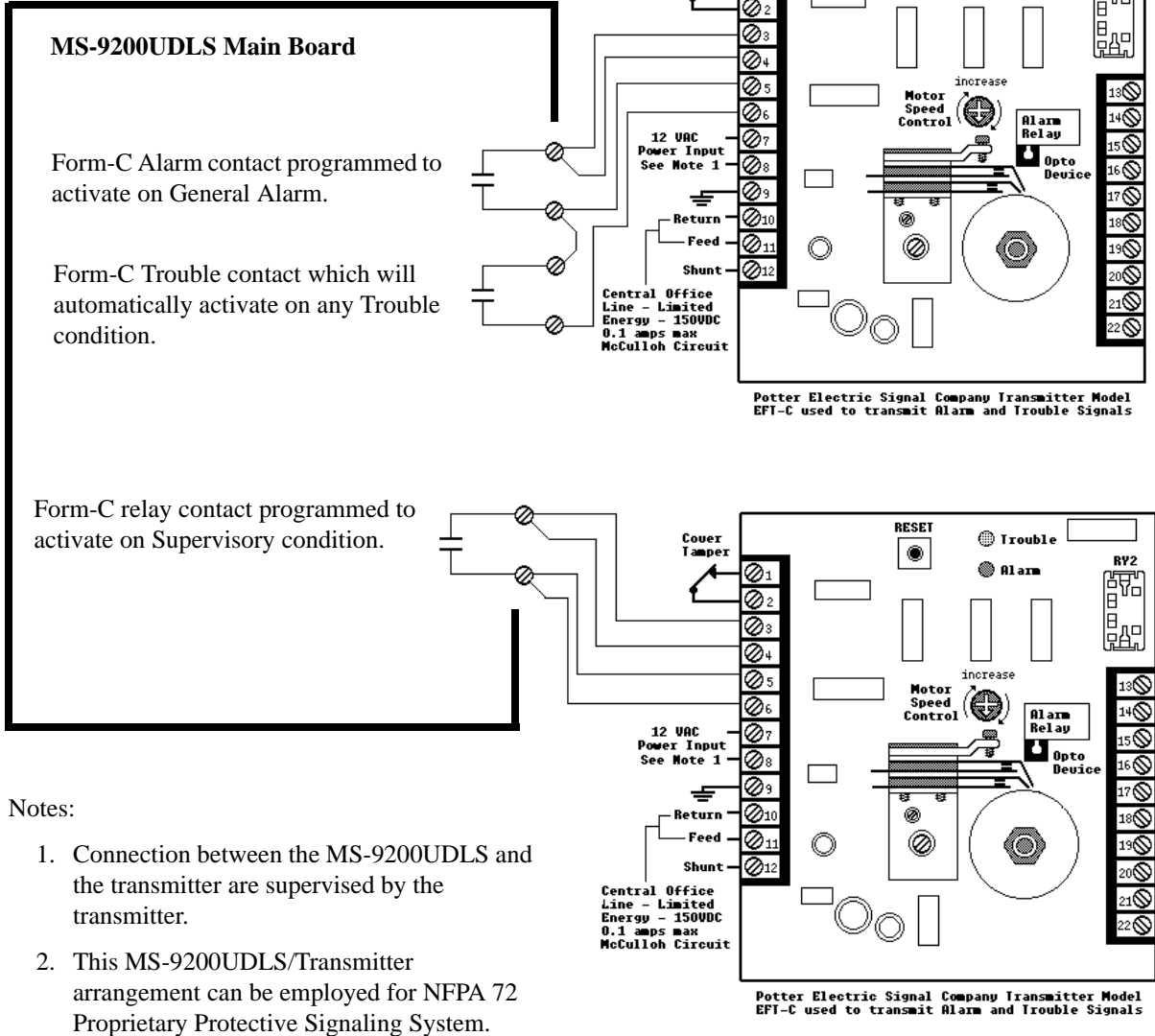

Figure C.3 Proprietary Protective Signaling System

C.1 Central Station/Remote Station Transmitter: Connection to FACP Dry Contacts

The dry contacts of the FACP programmable relays can be used to trip a UL-864 Listed Central Station/Remote Station Transmitter. The FACP contacts must be supervised by the Central Station/Remote Station Transmitter module using End-of-Line Resistors (ELRs) with a value determined by the Transmitter manufacturer. Power is also provided by the Central Station/Remote Station Transmitter manufacturer. Refer to the Central Station/Remote Station Transmitter manufacturer's manual for details.

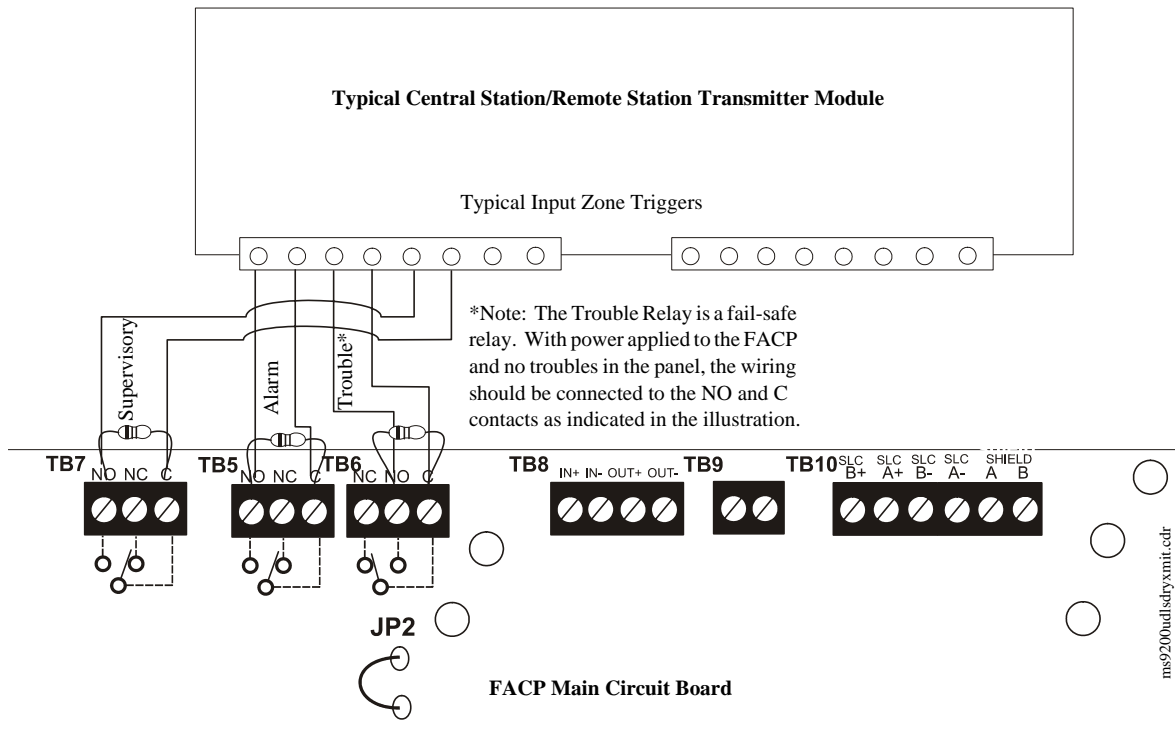
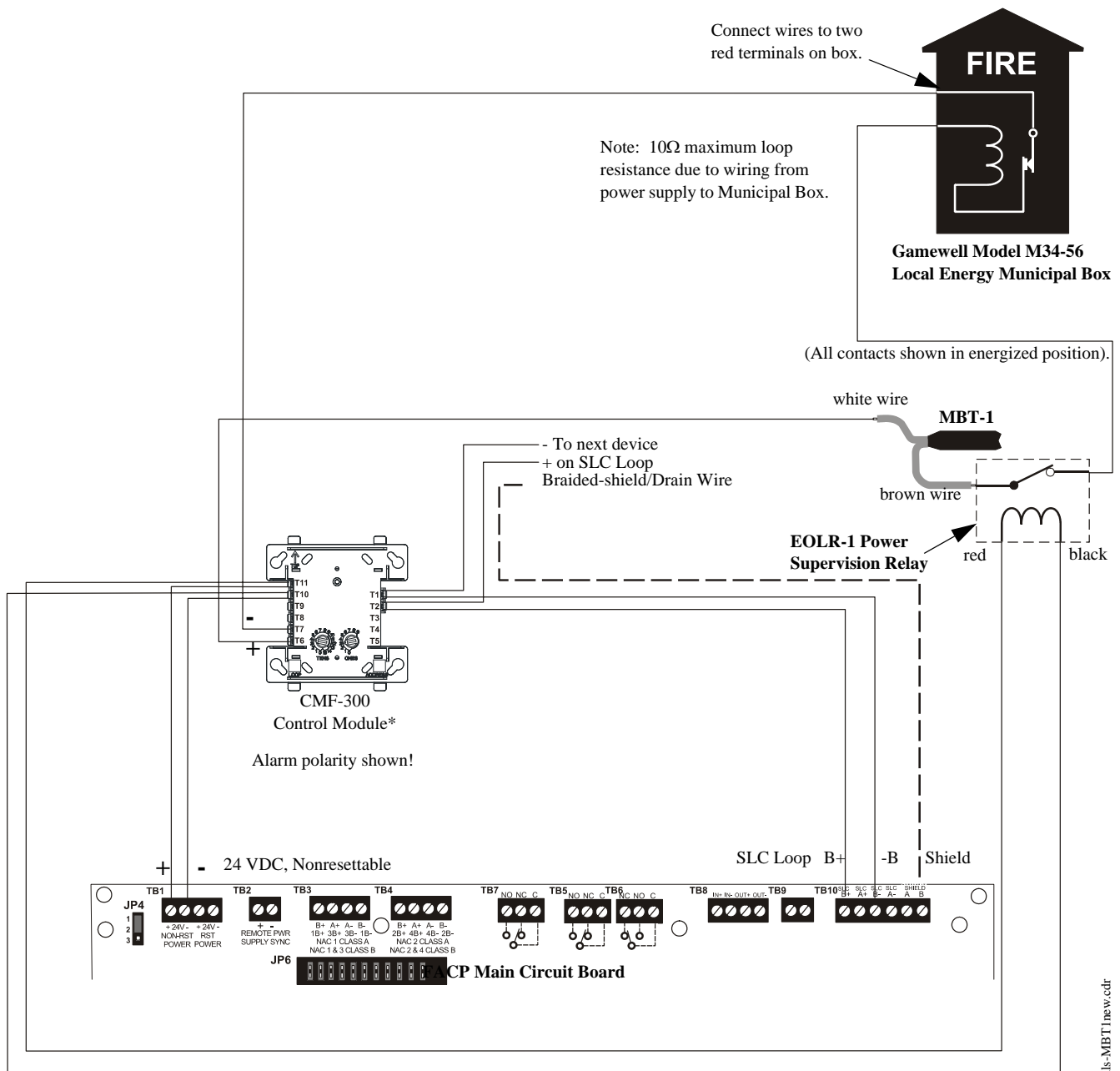

Figure C.4 FACP Dry Contacts Connection to Central Station/Remote Station Transmitter

C.2 MBT-1 Municipal Box Trip - Silenceable

The following figure illustrates the connection of the MBT-1 (Municipal Box Trip) between the FACP and a Local Energy Municipal Box. The use of an addressable control module programmed for *General Alarm* and *Silenceable* allows silencing of the Municipal Box without resetting the panel or box.

The addressable Control Module must be programmed as *Silenceable* and *General Alarm*.



*If the SLC device does not match the one in this figure, refer to the SLC manual wiring conversion charts for legacy and newer versions of the modules.

Figure C.5 MBT-1 Silenceable

92udls-MBT1new.cdr

APPENDIX D FACP with Keltron

The following figure illustrates the connections between the FACP and Keltron Receiver/Transmitter.

CAUTION! For reasons of wiring diagram clarity, terminal designations of Keltron modules are not shown in actual order. Follow Keltron manual and module markings for exact terminal locations to prevent severe module damage!

IMPORTANT! All connections between the FACP and Keltron modules must be made within 20 feet and enclosed within conduit or equivalently protected against mechanical injury.

Keltron 95M3158 TTM-RPS

1. Terminals 7 and 8: Remote station alarm/trouble inputs.
2. Terminals 9 and 10: Sprinkler supervisory input.

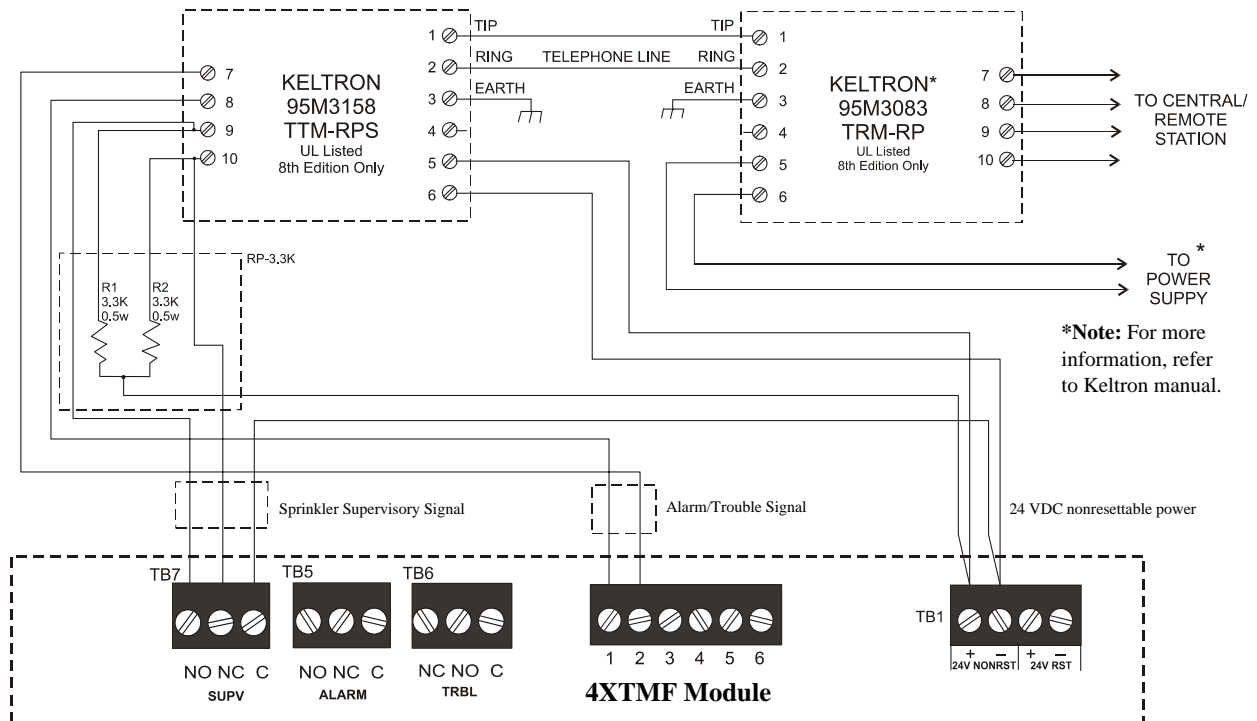

Fire Alarm Control Panel
(terminal blocks are not shown in their actual positions in order to clarify wiring connections.)

APPENDIX E

Wire Requirements

T-tapping of the SLC loop wiring is allowed for 2-wire (Style 4) configurations. The total resistance of any branch cannot exceed 40 ohms. The total wire length of all branches cannot exceed 10,000 feet (3,000 m).

Connecting external system accessories to the MS-9200UDLS main circuits must be carefully considered to ensure proper operation. It is important to use the correct type of wire, gauge and run length for each MS-9200UDLS circuit. Reference the chart below to specify wire requirements and limitations for each MS-9200UDLS circuit.

Note:

1. If the SLC loop is to be run in conduit with Notification Appliance Circuits, the risk of encountering problems can be greatly reduced by exclusively employing electronic sounders instead of more electronically noisy notification appliances such as electromechanical bells or horns.
2. The SLC can be programmed to operate in LiteSpeed mode (factory default setting) for a quicker device response time. While shielded wire is not required in LiteSpeed mode, it is recommended that all SLC wiring be twisted-pair to minimize the effects of electrical interference. Use the following table to determine the specific wiring requirements for the SLC when unshielded wire is used:

Refer Table E.1 on page 206 and Table E.2 on page 207 for wiring requirements.

Table E.1 FACP Wire Specifications

CIRCUIT CONNECTIONS		WIRE REQUIREMENTS		
Circuit Type	Circuit Function	Wire Type and Limitations	Recommended Max. Distance Feet (meters)	Wire Gauge and Compatible Brands
SLC loop (power-limited)	Connects to Addressable Devices CLIP MODE	Twisted, shielded pair 40 ohms maximum per length of Style 6 and 7 loops. 40 ohms per branch maximum for Style 4 loops	10,000 (3,000 m)	12 AWG (3.25 mm ²): Genesis 4410, Signal 98230, Belden 9583, WPW999 14 AWG (2.00 mm ²): Genesis 4408 & 4608 Signal 98430, Belden 9581, WPW995 16 AWG (1.30 mm ²): Genesis 4406 & 4606 Signal 98630, Belden 9575, WPW991 <u>Direct Burial Cable Isotec NP713110VNQ-S</u> 18 AWG (0.75 mm ²): Genesis 4402 & 4602 Signal 98300, Belden 9574, WPW975 <u>Direct Burial Cable Isotec NP714110VNQ-S</u>
			8,000 (2,400 m)	
			4,875 (1,450 m)	
			3,225 (980 m)	
LITESPEED MODE	Twisted, unshielded pair 40 ohms maximum per length of Style 6 and 7 loops. 40 ohms per branch maximum for Style 4 loops	10,000 (3,000 m)	12 AWG (3.25 mm ²): Belden 5020UL & 6020UL, Genesis WG-4315 & WG-4515 14 AWG (2.00 mm ²): Belden 5120UL & 6120UL, Genesis WG-4313 & WG-4513 16 AWG (1.30 mm ²): Belden 5220UL & 6220UL, Genesis WG-4311 & WG-4511 18 AWG (0.75 mm ²): Belden 5320UL & 6320UL, Genesis WG-4306 & WG-4506	
		8,000 (2,400 m)		
		4,875 (1,450 m)		
		Untwisted, unshielded pair ¹	3,000 (900 m)	12-18 AWG (3.25 - 0.75 mm ²) using listed wire
ACS-BUS (EIA-485) (power-limited)	Connects to annunciator modules	Twisted pair with a characteristic impedance of 120 ohms	6,000 (1,800 m)	12 AWG (0.75 mm ²)
ANN-BUS (EIA-485) (power-limited)	Connects to annunciator modules	Twisted pair	6,000 (1,800 m)	Refer to "ANN-BUS Wiring" on page 24 for information on device wiring
EIA-232 (power-limited)	connects to remote PC computer	Twisted, shielded pair	50 (15 m)	18 AWG (0.75 mm ²) minimum
MMF-300 and MMF-301 (power-limited)	Initiating Device Circuit	Maximum loop wire resistance is 40 ohms for the MMF-300 and 20 ohms for the MMF-301	2,500 (760 m)	12-18 AWG (3.25 - 0.75 mm ²)
MMF-302 (power-limited)	Initiating Device Circuit	No more than a 2.4 volt drop allowed at end of circuit. Maximum loop wire resistance is 25 ohms	2,500 (760 m)	12-18 AWG (3.25 - 0.75 mm ²)
CMF-300 (power-limited)	Notification Appliance Circuit	In alarm, no more than a 1.2 volt drop allowed at end of circuit	Distance limitation set by 1.2 volt maximum line drop	12-18 AWG (3.25 - 0.75 mm ²)
Remote Sync Output	Provides strobe and normal sync for remote NAC power supplies	Untwisted, unshielded pair wire	Distance set by 295 ohm resistance limitation	12-18 AWG (3.25 - 0.75 mm ²)

Table Footnote

1. When using untwisted, unshielded wire, full conduit is recommended for optimum EMI/RFI protection.

E.1 NAC Wiring

The following table lists NAC wiring requirements for the FACP.

Table E.2 NAC Wiring Requirements for FACP

NAC Load (Amps)	Max. allowable total loop resistance (ohms)	CLASS-B Max. allowable wire pair length (feet)				CLASS-A Max. allowable wire pair length (feet)			
		AWG 12 solid	AWG 14 solid	AWG 16 solid	AWG 18 solid	AWG 12 solid	AWG 14 solid	AWG 16 solid	AWG 18 solid
0.25	12.72	3295	2072	1301	819	1648	1036	650	409
0.5	6.36	1648	1036	650	409	824	518	325	205
0.75	4.24	1098	691	434	273	549	345	217	136
1	3.18	824	518	325	205	412	259	163	102
1.25	2.54	659	414	260	164	330	207	130	82
1.5	2.12	549	345	217	136	275	173	108	68
1.75	1.82	471	296	186	117	235	148	93	58
2	1.59	412	259	163	102	206	129	81	51
2.25	1.41	366	230	145	91	183	115	72	45
2.5	1.27	330	207	130	82	165	104	65	41

Notes:

1. Calculations are based on Direct-Current Resistance data for **uncoated copper wire**, per National Electrical Code (2005 Edition) Table 8, Conductor Properties.

APPENDIX F HVAC Control

The FACP can be programmed to shut down a building's HVAC fans in the event of a fire. The fans cannot be restarted until the fire alarm condition has been cleared and the FACP has been reset to a normal (non-alarm) condition.

IMPORTANT! *This HVAC feature is not to be used for smoke control. It is only designed to shut down fans during a fire alarm condition.*

F.1 Control Module Operation

F.1.1 HVAC SHUTDN

The **HVAC SHUTDN** type code can be assigned to any addressable control relay module for the purpose of shutting down HVAC fans during a fire alarm condition. Devices connected to a module with this type code are unsupervised. To program this feature in the FACP:

- Program the **HVAC SHUTDN** type code to the control module which will be used to shut down the fans (refer to *Type* under the section titled "Edit Module Screen for Control Modules" on page 85).
- Program the control module to a software zone and program alarm input devices which, when activated are to cause fan shutdown, to the same software zone (refer to *Zone Assignment* under the section titled "Edit Module Screen for Control Modules" on page 85).
- Monitor the control module using an addressable monitor module programmed for *Trouble Monitor*. The monitor module label should be programmed to indicate HVAC SHUTDOWN. When the control module is active (HVAC SHUTDN), the monitor module will indicate a trouble condition at the FACP and the display should indicate the HVAC is shut down.

Once activated, the HVAC SHUTDN control module remains activated, even if the FACP is silenced or reset. After the alarm condition on the FACP has been cleared and the panel reset, the HVAC SHUTDN control module remains activated and the fans remain off. The monitor module programmed for *Trouble Monitor* which is being used to supervise the control module, will indicate a trouble condition at the control panel and the LCD should display that the HVAC is shut down. The fans can only be restarted when the HVAC SHUTDN control module is deactivated by the HVAC RESTART module.

F.2 Monitor Module Operation

F.2.1 HVAC RESTART

The **HVAC RESTART** type code can be assigned to any addressable monitor module for the purpose of resetting (deactivating) the HVAC SHUTDN control module and turning the fans back on. The **HVAC RESTART** monitor module acts globally throughout the FACP system and therefore is not programmed to a particular software zone. To program this feature in the FACP:

- Program the **HVAC RESTART** type code to the monitor module which will be used to deactivate the HVAC SHUTDN control module and restart the fans (refer to *Type Monitor* under the section titled "Edit Module Screen for Monitor Module" on page 76).

The HVAC RESTART monitor module does not latch when activated. Pressing a switch connected to the monitor module will deactivate the HVAC SHUTDN control relay module *only if there are no alarm conditions*. The HVAC SHUTDN control relay module can be deactivated if trouble conditions exist on the FACP.

F.2.2 HVAC OVRRIDE

The **HVAC OVRRIDE** type code can be assigned to any addressable monitor module for the purpose of overriding or preventing the HVAC SHUTDN control modules from activating. The **HVAC OVRRIDE** monitor module acts globally throughout the FACP system and therefore is not programmed to a particular software zone. To program this feature in the FACP:

- Program the **HVAC OVRRIDE** type code to the monitor module which will be used to override the HVAC SHUTDN control module and prevent the fans from turning off (refer to Type Monitor under the section titled "Edit Module Screen for Monitor Module" on page 76).

The HVAC OVRRIDE monitor module does not latch when activated. Activating a switch connected to the monitor module will override all HVAC SHUTDN control relay modules in the system, preventing the HVAC SHUTDN modules from activating and causing the FACP LCD to display an active HVAC OVRRIDE module and turn on the Supervisory LED. Releasing the switch will allow the HVAC SHUTDN control relay modules to activate with subsequent alarms, turning off the fans.

As an example, pressing the HVAC OVRRIDE switch with no alarms in the system will prevent the fans from being turned off when an alarm does occur. As long as the switch is activated, the fans will not shutdown for any alarms. If the system is still in alarm when the switch is released, the fans will not shutdown unless another alarm occurs after the switch is released.

Important! *If an alarm exists in the system and HVAC Shutdown has already occurred, HVAC OVRRIDE will have no effect on the HVAC SHUTDN control relay modules. HVAC OVRRIDE will prevent HVAC Shutdown from occurring only if it is initiated prior to an alarm condition.*

Note: Activation of the HVAC OVRRIDE module causes a supervisory event that will be communicated to the Central Station if enabled.

APPENDIX G Ademco Contact ID Format Event Code Descriptions

This appendix describes the various Event Codes and their messages which are available for the Ademco Contact ID Format.

G.1 Transmission Format Between DACT and Receiver

The transmission string for the Ademco Contact ID Format is as follows:

SSSS 18 QXYZ GG CCC where

- SSSS** = Four digit Subscriber ID Account Code
- 18** = Identifies transmission as Contact ID to the receiver at the Central Station
- Q** = Event Qualifier where 1 = New Event and 3 = New Restore
- XYZ** = Event code
- GG** = Group number
- CCC** = Zone/Point number

Notes:

1. **18**, which is used in the reporting structure to identify the transmission as Contact ID, is not printed out in the alarm and trouble report.
2. **GG** Group Number is fixed at '00' and cannot be changed.
3. **CCC** for Zone or Point Number:
 - ✓ Zone Number is transmitted as '01' for zone 1 up to '99' for zone 99
 - ✓ Point Number is transmitted as '01' for point/address 1 up to '99' for point/address 99

G.2 Ademco Contact ID Typical Printout

A typical printout from a Central Station receiver (such as the Ademco 685) of alarm and trouble reports in the Ademco Contact ID Reporting Structure follows:

Time	Date	Rcvr/Line ID	SSSS	QXYZ	GG	CCCC
11:28	03/25	11	7777	E110	00	C001 - general fire alarm on zone one
11:28	03/25	11	7777	E111	00	C002 - smoke detector alarm on zone two
11:28	03/25	11	7777	E380	00	C003 - fault on zone three
11:28	03/25	11	7777	E570	00	C009 - Zone nine disabled
11:28	03/25	11	7777	R110	00	C001 - Zone one alarm restored
11:28	03/25	11	7777	R111	00	C002 - smoke detector zone two restored
11:28	03/25	11	7777	R380	00	C003 - zone three fault restored
11:28	03/25	11	7777	R570	00	C009 - zone nine reenabled
11:28	03/25	11	7777	E158	00	C006 - high temperature, zone six
11:28	03/25	11	7777	E151	00	C007 - gas detected, zone seven

Notes:

1. **11** is an example of a Receiver/Line Card, showing which receiver and line card the message was transmitted to.
2. **Q**, which is the Event Qualifier for the reporting structure, is printed out in the report as an **E** for New Event or **R** for New Restore.

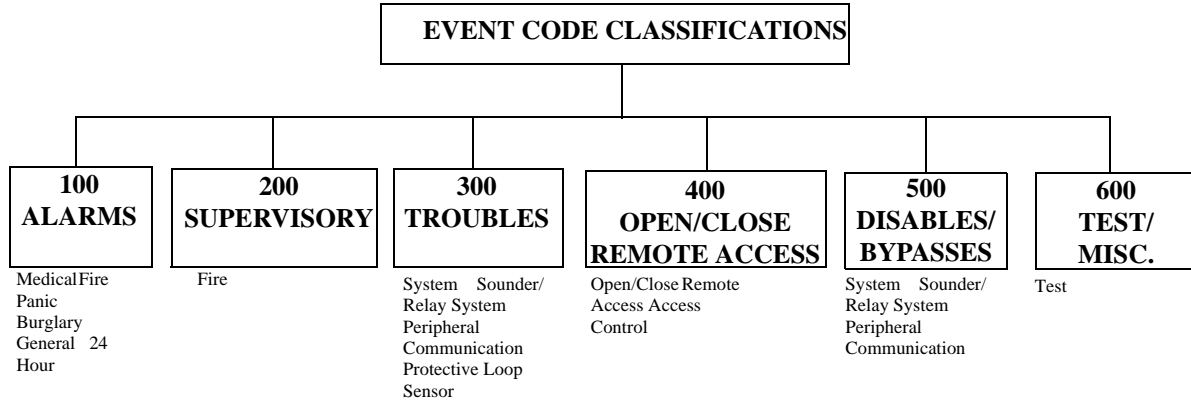

EVENT	MESSAGE
<u>Medical Alarms - 100</u>	
100 Medical	EMERG - Personal Emergency - #
101 Pendant transmitter	EMERG - Personal Emergency - #
102 Fail to report in	EMERG - Fail to Check-in - #
<u>Fire Alarms - 110</u>	
110 Fire Alarm	FIRE - Fire Alarm - #
111 Smoke	FIRE - Smoke Detector - #
112 Combustion	FIRE - Combustion - #
113 Waterflow	FIRE - Waterflow - #
114 Heat	FIRE - Heat Sensor - #
115 Pull station	FIRE - Pull Station - #
116 Duct	FIRE - Duct Sensor - #
117 Flame	FIRE - Flame Sensor - #
118 Near Alarm	FIRE - Near Alarm - #
<u>Panic Alarms - 120</u>	
120 Panic Alarm	PANIC - Panic - #
121 Duress	PANIC - Duress
122 Silent	PANIC - Silent Panic - #
123 Audible	PANIC - Audible Panic - #
<u>Burglar Alarms - 130</u>	
130 Burglary	BURG - Burglary - #
131 Perimeter	BURG - Perimeter - #
132 Interior	BURG - Interior - #
133 24-Hour	BURG - 24-Hour - #
134 Entry/Exit	BURG - Entry/Exit - #
135 Day/Night	BURG - Day/Night - #
136 Outdoor	BURG - Outdoor - #
137 Tamper	BURG - Tamper - #
138 Near Alarm	BURG - Near Alarm - #
<u>General Alarms - 140</u>	
140 General Alarm	ALARM - General Alarm - #
141 Polling loop open	ALARM - Polling Loop Open - #
142 Polling loop short	ALARM - Polling Loop Short - #
143 Expansion module failure	ALARM - Exp. Module Fail - #
144 Sensor tamper	ALARM - Sensor Tamper - #
145 Expansion module tamper	ALARM - Exp. Module Tamper - #

EVENT	MESSAGE
<u>24 Hour Non-Burglary - 150 and 160</u>	
150 24-Hour Non-Burg	ALARM - 24-Hr. Non-Burg - #
151 Gas detected	ALARM - Gas Detected - #
152 Refrigeration	ALARM - Refrigeration - #
153 Loss of heat	ALARM - Heating System - #
154 Water leakage	ALARM - Water Leakage - #
155 Foil break	ALARM - Foil Break - #
156 Day trouble	ALARM - Day Zone - #
157 Low bottled gas level	ALARM - Low Gas Level - #
158 High temp	ALARM - High Temperature - #
159 Low temp	ALARM - Low Temperature - #
161 Loss of air flow	ALARM - Air Flow - #
<u>Fire Supervisory - 200 and 210</u>	
200 Fire supervisory	SUPER. - Fire Supervisory - #
201 Low water pressure	SUPER. - Low Water Pressure - #
202 Low CO2	SUPER. - Low CO2
203 Gate valve sensor	SUPER. - Gate Valve - #
204 Low water level	SUPER. - Low Water Level - #
205 Pump activated	SUPER. - Pump Activation - #
206 Pump failure	SUPER. - Pump Failure - #
<u>System Troubles - 300 and 310</u>	
300 System trouble	TROUBLE - System Trouble
301 AC loss	TROUBLE - AC Power
302 Low system battery	TROUBLE - System Low Battery
303 RAM checksum bad	TROUBLE -RAM Checksum (restore not applicable)
304 ROM checksum bad	TROUBLE -ROM Checksum (restore not applicable)
305 System reset	TROUBLE - System Reset (restore not applicable)
306 Panel program changed	TROUBLE - Prog. Change (restore not applicable)
307 Self-test failure	TROUBLE - Self Test Failure
308 System shutdown	TROUBLE - System Shutdown
309 Battery test failure	TROUBLE - Battery Test Failure
310 Ground fault	TROUBLE - Ground Fault - #
311 No battery	TROUBLE - No Battery
<u>Sounder/Relay Troubles - 320</u>	
320 Sounder/Relay	TROUBLE - Sounder Relay - #
321 Bell 1	TROUBLE - Bell/Siren #1
322 Bell 2	TROUBLE - Bell/Siren #2
323 Alarm relay	TROUBLE - Alarm Relay
324 Trouble relay	TROUBLE - Trouble Relay
325 Reversing	TROUBLE - Reversing Relay
326 Bell 3	TROUBLE - Bell/Siren #3
327 Bell 4	TROUBLE - Bell/Siren #4
<u>System Peripheral Troubles - 330 and 340</u>	
330 System peripheral	TROUBLE - Sys. Peripheral - #
331 Polling loop open	TROUBLE - Polling Loop Open
332 Polling loop short	TROUBLE - Polling Loop Short
333 Expansion module failure	TROUBLE - Exp. Module Fail - #
334 Repeater failure	TROUBLE - Repeater Failure - #
335 Local printer paper out	TROUBLE - Printer Paper Out
336 Local printer failure	TROUBLE - Local Printer

EVENT MESSAGE

Communication Troubles - 350 and 360

350 Communication	TROUBLE - Communication Trouble
351 Telco 1 fault	TROUBLE - Phone Line #1
352 Telco 2 fault	TROUBLE - Phone Line #2
353 Long range radio xmitter fault	TROUBLE - Radio Transmitter
354 Fail to communicate	TROUBLE - Fail to Communicate
355 Loss of radio supervision	TROUBLE - Radio Supervision
356 Loss of central polling	TROUBLE - Central Radio Polling

Protection Loop Troubles - 370

370 Protection loop	TROUBLE - Protection Loop - #
371 Protection loop open	TROUBLE - Protection Loop Open - #
372 Protection loop short	TROUBLE - Protection Loop Short - #
373 Fire Trouble	TROUBLE - Fire Loop - #

Sensor Troubles - 380

380 Sensor trouble	TROUBLE - Sensor Trouble - #
381 Loss of supervision - RF	TROUBLE - RF Sensor Supervision - #
382 Loss of supervision - RPM	TROUBLE - RPM Sensor Supervision - #
383 Sensor tamper	TROUBLE - Sensor Tamper - #
384 RF transmitter low battery	TROUBLE - RF Sensor Batt. - #

Open/Close - 400

400 Open/Close	OPENING	CLOSING
401 Open/Close by user	OPENING - User #	CLOSING - User #
402 Group Open/Close	OPENING - Group User #	CLOSING - Group User #
403 Automatic Open/Close	OPENING - Automatic	CLOSING - Automatic
404 Late Open/Close	OPENING - Late	CLOSING - Late
405 Deferred Open/Close	Opening not used	Closing not used
406 Cancel	OPENING - Cancel	Closing not used
407 Remote arm/disarm	OPENING - Remote	CLOSING - Remote
408 Quick arm	Opening not applicable	CLOSING - Quick arm
409 Keyswitch Open/Close	OPENING - Keyswitch	CLOSING - Keyswitch

Remote Access - 410

411 Callback request made	REMOTE - Callback Requested (restore not applicable)
412 Success - download/access	REMOTE - Successful Access (restore not applicable)
413 Unsuccessful access	REMOTE - Unsuccessful Access (restore not applicable)
414 System shutdown	REMOTE - System Shutdown
415 Dialer shutdown	REMOTE - Dialer Shutdown
416 Success - upload/access	REMOTE - Successful Access (restore not applicable)

Access Control - 420

421 Access denied	ACCESS - Access Denied - User # (restore not used)
422 Access report by user	ACCESS - Access Gained - User # (restore not used)

System Disables - 500 and 510

EVENT	MESSAGE
<u>Sounder/Relay Disables - 520</u>	
520 Sounder/Relay disable	DISABLE - Sounder/Relay - #
521 Bell 1 disable	DISABLE - Bell/Siren - #1
522 Bell 2 disable	DISABLE - Bell/Siren - #2
523 Alarm relay disable	DISABLE - Alarm Relay
524 Trouble relay disable	DISABLE - Trouble Relay
525 Reversing relay disable	DISABLE - Reversing Relay
526 Bell 3 disable	DISABLE - Bell/Siren - #3
527 Bell 4 disable	DISABLE - Bell/Siren - #4
 <u>System Peripheral Disables - 530 and 540</u>	
 <u>Communication Disables - 550 and 560</u>	
551 Dialer disabled	DISABLE - Dialer Disable
552 Radio transmitter disabled	DISABLE - Radio Disable
 <u>Bypasses - 570</u>	
570 Zone bypass	BYPASS - Zone Bypass - #
571 Fire bypass	BYPASS - Fire Bypass - #
572 24-Hour zone bypass	BYPASS - 24-Hour Bypass - #
573 Burglar bypass	BYPASS - Burg. Bypass - #
574 Group bypass	BYPASS - Group Bypass - #
 <u>Test Misc. - 600</u>	
601 Manual trigger test	TEST - Manually Triggered (restore not applicable)
602 Periodic test report	TEST - Periodic (restore not applicable)
603 Periodic RF transmission	TEST - Periodic Radio (restore not applicable)
604 Fire test	TEST - Fire Test (restore not used)
605 Status report to follow	STATUS - Status Follows (restore not applicable)
606 Listen-in to follow	LISTEN - Listen-in Active (restore not applicable)
607 Walk test mode	TEST - Walk Test Mode
608 System abnormal test	TEST - System Abnormal Test

APPENDIX H

Central Station Points

The control panel transmits Central Station Reports in a numerical format which indicates the FACP addressable device address that is reporting. The following table indicates the Central Station Report (CS Report) number that will be transmitted and the addressable device address it represents.

Table H.1 Addressable DETECTORS

CS Report	Detector Address	CS Report	Detector Address	CS Report	Detector Address	CS Report	Detector Address
001	001	033	033	065	065	097	097
002	002	034	034	066	066	098	098
003	003	035	035	067	067	099	099
004	004	036	036	068	068	100 not used ↓ through ↓ 159 not used	
005	005	037	037	069	069		
006	006	038	038	070	070		
007	007	039	039	071	071		
008	008	040	040	072	072		
009	009	041	041	073	073		
010	010	042	042	074	074		
011	011	043	043	075	075		
012	012	044	044	076	076		
013	013	045	045	077	077		
014	014	046	046	078	078		
015	015	047	047	079	079		
016	016	048	048	080	080		
017	017	049	049	081	081		
018	018	050	050	082	082		
019	019	051	051	083	083		
020	020	052	052	084	084		
021	021	053	053	085	085		
022	022	054	054	086	086		
023	023	055	055	087	087		
024	024	056	056	088	088		
025	025	057	057	089	089		
026	026	058	058	090	090		
027	027	059	059	091	091		
028	028	060	060	092	092		
029	029	061	061	093	093		
030	030	062	062	094	094		
031	031	063	063	095	095		
032	032	064	064	096	096		

Table H.2 Addressable MODULES

CS Report	Module Address	CS Report	Module Address	CS Report	Module Address	CS Report	Module Address
160	001	192	033	224	065	256	097
161	002	193	034	225	066	257	098
162	003	194	035	226	067	258	099
163	004	195	036	227	068		
164	005	196	037	228	069		
165	006	197	038	229	070		
166	007	198	039	230	071		
167	008	199	040	231	072		
168	009	200	041	232	073		
169	010	201	042	233	074		
170	011	202	043	234	075		
171	012	203	044	235	076		
172	013	204	045	236	077		
173	014	205	046	237	078		
174	015	206	047	238	079		
175	016	207	048	239	080		
176	017	208	049	240	081		
177	018	209	050	241	082		
178	019	210	051	242	083		
179	020	211	052	243	084		
180	021	212	053	244	085		
181	022	213	054	245	086		
182	023	214	055	246	087		
183	024	215	056	247	088		
184	025	216	057	248	089		
185	026	217	058	249	090		
186	027	218	059	250	091		
187	028	219	060	251	092		
188	029	220	061	252	093		
189	030	221	062	253	094		
190	031	222	063	254	095		
191	032	223	064	255	096		

- Numerics
 - 24 Hour Test Time 137
 - 300 Series addressable devices 21
 - 4XTMF module 199, 200
 - coil resistance 56
 - current 56
 - installation 56
 - installation steps 57
 - see also Transmitter Module 15, 21
 - supervisory relay config. 57
 - voltage 56
- A
 - AC Branch Circuit
 - calculations 187
 - AC Loss Delay 104
 - AC Power 49
 - current 16
 - current, maximum 49
 - voltage 16
 - wiring 16, 49
 - Account Code 136
 - Acknowledge/Step 18, 156
 - ACM Series
 - see also annunciator 41
 - ACM-16ATF Annunciator 41
 - ACM-32AF Annunciator 41
 - ACM-8RF 15
 - contact rating 41
 - see also Relay Control Module 41
 - ACS 41
 - ACS LED annunciator 15
 - add Detector 65
 - add Module 75
 - addressable 14
 - addressable detectors
 - see also detectors 15
 - Addressable Device Accessories 21
 - addressable modules 20
 - see also modules 15
 - addressing
 - annunciators 117
 - see also device addressing 97
 - see also module or detector addressing 20
 - Ademco Contact ID format 210
 - Adjective
 - control module 89
 - list 72
 - monitor module 82
 - multiple entries 74
 - AEM-16ATF Annunciator 41
 - AEM-32AF Annunciator 41
 - Alarm 160
 - Alarm Silence 18, 156
 - alarm verification 15, 69, 163, 166
 - ANN-LED 39
 - ANN-LED Annunciator Module 38
 - annunciator 24
 - ACM 15, 117
 - ACM-8RF 15
 - LCD-80F 15
 - LDM Graphic 15
 - annunciator addressing 117
 - annunciator, graphic
 - see also LDM Series 41
 - annunciator, remote
 - see also LCD-80F 41
 - Automatic Test Operation 163
 - Autoprogramming 15, 60, 64
 - Autosilence 15, 166
 - NAC 107
 - auxiliary DC power 49- B
 - backbox 20
 - see also cabinet 48
 - Backup Reporting 134
 - Banner 97
 - setting 98
 - battery 20
 - cable connection 49
 - charger 19
 - charger capacity 16
 - Charging Circuit 16
 - see also secondary power 16, 49
 - battery box 22
 - battery charger 23
 - disable 16
 - external 23
 - baud rate 142
 - BB-55F
 - see also battery box 20, 22- C
 - cabinet
 - dimensions 47, 48
 - cabinet mounting 45
 - Calculate System Current Draw 188
 - Calculating the Battery Size 190
 - Canadian Applications 44
 - Canadian Option 97, 111

- Central Station 133, 186
 - account code 136
 - communications 181
 - phone number 137
 - Phone Numbers 135
 - point assignments 215
 - report style 141
- Central Station Reports 215
- CHG-120F
 - see also battery charger 23
 - see also remote battery charger 16
- CHG-75
 - see also battery charger 23
 - see also remote battery charger 16
- Classic Loop Interface Protocol 97
- Class A 50
- Class B 50
 - NAC wiring 51
- CLIP mode
 - see also Classic Loop Interface Protocol 97
- Clock Format 101
- Coded Operation 164
- Coding
 - NAC 107
- coding
 - two stage operation 108
- communications format 138
- Control Buttons 156
- control module 20
 - description display 91
 - display 85
 - edit 85
 - enable/disable 86
 - noun 90
 - noun/adjective 88, 89
 - silenceable 88
 - type 87
 - type codes 87
- Correlations 191
- current
 - AC Power 49
 - availability 17
 - maximum 17
- Current Draw Calculations 189
- D
- DACT
 - enable 131
 - onboard 131
- data
 - see also detector data and sensitivity 163
- Data Entry
 - via computer keyboard 59
 - via keypad 59
- data values
 - see also detector data and sensitivity 15
- Date setting 101
- Daylight Savings Time 101
- DC power
 - nonresettable 49
 - resettable 49
 - see also auxiliary DC power 49
- Default Programming 197
- Delete Detector 66
- Delete Module 76
- Description
 - control module 91
 - detector label 74
 - monitor module 84
- Detector
 - add 65
 - adding description 71
 - delete 66
 - edit 66
 - enable/disable 68
 - screen display 67
 - type 69
 - verification 69
- detector data 163, 178, 179
 - acceptable range 178
 - printout 178
- Detector Programming 65
- device addressing 97
- Digital Communicator 42
- dimensions
 - cabinet 47
- DIRTY1 179
- DIRTY2 179
- Disable 93
- Disable Point
 - Maintenance Level 148
- Downloading 185
- dress panel 20, 22
- drift compensation 15, 179
 - definition 179
- Drill 18, 156
- E
- earth ground 49
- edit

- control module 85
- detector 66
- detector screens 67
- module, monitor 76
- EIA-232 58
 - for PC/Printer connection 17
 - see also Printer/PC interface 15
- EIA-485
 - for ACS annunciators 17
 - for LCD-80F 17
- Enable 92
- Enable/Disable
 - control module 86
 - detector 68
 - module, monitor 79
- End-of-Line Resistor Assembly 21
- Enter key 62
- Erase History 112
- Error Checking 186
- event code classification 211
- event codes 138
- exiting
 - programming 61, 62
 - Read Status 61, 62
- F
- FACP
 - see also Fire Alarm Control Panel 14
- Features 14
- Fire Alarm Control Panel
 - see also FACP 14
- Form-C relay 19, 41, 50
- G
- general alarm zone 81
 - see also zone Z00 71
- ground fault 58
- H
- Hazard Condition 162
- History 112
 - erase 112
 - Maintenance Level 149
 - view events 112
- History file 15
- HVAC Control 208
- HVAC OVERRIDE 209
- HVAC RESTART 208
- HVAC SHUTDN 208
- I
- Indicators 18
- Installation 45
- intelligent 14
- Internet Protocol DACT 23
- Inventory 14
- INVREP 179
- IPDACT 23
- K
- Key Panel 18
 - function keys 18
 - service/program keys 18
- keyboard and keypad 59
- Keypad/Display
 - removal and installation 55
- L
- lamp test 18
- LCD display 15, 18
- LCD-80F annunciator 15, 41
- LDM Series annunciator 41
- LDM-32 Graphic Annunciator 15
- LED
 - AC Power 157
 - Alarm Silenced 157
 - Battery 157
 - Disabled 157
 - Fire Alarm 157
 - Ground 157
 - Kiss-off 157
 - Maintenance 157
 - Primary Line Active 157
 - Secondary Line Active 157
 - see also Indicators 18
 - Supervisory 157
 - Trouble 157
- LED annunciator 41
- Local Energy Municipal Box Service 56
- Local Programming 60
- Loop Setup 96
- M
- Maintenance Alert 15, 163
 - levels 179
- maintenance alert 179
- Maintenance Program Level 2 61, 147
- Manual programming 60
- Master Program Level 1 61, 63
- Medical Alert 162
- Mode key 62
- Module
 - add 75
 - addressing 20
 - delete 76

- edit monitor 76
- enable/disable 79
- see also addressable modules 20
- Module Programming 75
- Monitor module 20
 - adjective 82
 - enable/disable 79
 - noun 83
 - noun/adjective 81
 - type 79
 - type action 80
 - Type list 79
 - type selection 80
- Mounting
 - cabinet 45
 - main circuit board 45
- municipal box transmitter
 - see also 4XTMF module 56
- N
- NAC 16, 19, 104, 106, 162
 - Auto Silence 107
 - coded 164
 - coding 107
 - current 16
 - End-of-Line Resistor 16
 - power 14
 - see also Notification Appliance Circuit 14, 50
 - silence inhibit 109
 - silenceable 106
 - Style configuration 51
 - Style Y wiring diagram 51
 - synchronized 164
 - type codes 106
 - voltage drop 16
 - voltage, operating 16
 - wiring Style 50
- NAC enable/disable 105
- NAC options 97
- NACKEY card 51
- N-ELR Mounting Plate 21
- NFPA 72 Auxiliary Fire Alarm System 198, 199
- NFPA 72 Central Station Service (Protected Premises Unit) or Remote Station Service 198
- NFPA 72 Proprietary Fire Alarm System 198
- NFPA 72 Proprietary Protective Signaling Systems 201
- NFPA 72 Remote Station Protective Signaling System 200
- NFPA Battery Requirements 190
- NFPA Standard 198
- nonpower-limited
 - relay connections 50
- Nonresettable Power 19
 - current 16, 49
- nonsilenceable
 - waterflow 95, 111
- Normal 158
- normal display 60
- Notification Appliance Circuit 16, 104
 - see also NAC 14, 50
- Noun
 - list 73
 - monitor module 83
 - multiple entries 74
- Noun/Adjective 71, 73
 - control module 88
 - monitor module 81
- O
- Operating Instructions 156
- Operation
 - alarm 160
 - disable/enable 163
 - hazard condition 162
 - medical alert 162
 - NAC 162
 - normal 158
 - process monitor 162
 - programmed zone 163
 - supervisory 161
 - trouble 158
 - waterflow 163
- Option Modules 21, 55, 115
 - annunciators/UDACT 115
 - Printer/PC 142
- Options 14
- Output Circuits 19
- P
- PAS 70, 93, 165
 - see also Positive Alarm Sequence 15, 70
- PAS BYPASS 165
- PAS timer 102
- Password 15, 62
 - change 143
 - Maintenance Level 2 62, 147
 - Master Level 1 62
- PC (personal computer)

- ground fault 58
- Phone Line 2
 - supervision 141
- Phone Number 137
- Piezo
 - see also sounder 18
- PK-CD Programming Utility 22
- point assignments 215
- Point Program 65
- Positive Alarm Sequence 70, 165
 - see also PAS 15
- power
 - NAC 14
 - nonresettable 16
 - resettable smoke 16
 - system 14
- power supply calculations 187
- power-limited
 - relay connections 50
- Power-up
 - first time 61
- Pre-signal 15, 70, 93
 - function 164
 - selection 81
- Pre-signal Delay timer 103
- Pre-signal timer 102
- Primary Phone 131
- primary power
 - see also AC Power 49
- printer
 - baud rate 142
 - configuration 58
 - connection 57
 - ground fault 58
 - setup 58
- Printer/PC interface 15
- Process Monitor 162
- PROCMON AR 110
- Program
 - check 145
 - check correlations 145
 - clear 144
- Program Check
 - Maintenance Level 150
- program keys
 - see also Key Panel 18
- Programming 59, 60
 - autoprogramming 60
 - exiting 61
 - factory default 197
 - Level 1 61
 - Level 2 61
 - manual 60
 - Master Level 1 63
 - modules 75
 - off-line computer 60
 - via computer keyboard 59
 - via panel keypad 59
- Programming Levels 61
- Programming Screens 61
- Programming Sheet 193, 194, 195
- Programming Utility
 - see also PK-CD 22
- Proprietary Yes
 - see also Remote Upload 185
- PRT/PK-CABLE
 - for PC/Printer connection 58
- R
- Read Status 60, 168
 - annunciators 174, 176
 - exiting 61
 - history 174
 - NAC 173
 - power 171
 - Print 178
 - printer/PC 177
 - program check 174
 - relay 173
 - system point 169
 - Time-Date 180
 - timers 172
 - trouble reminder 172
 - zones 170
- Real-Time Clock 163
- Recall/Increment Function 74, 84, 91
- Receivers 183
- Relay 16, 19, 50, 110
 - connections 50
 - contact rating 16, 19, 50
 - fixed 50
 - Form-C 16, 110
 - programmable 14, 19, 50
 - programming 110
 - selections 110
 - trouble 14, 19, 50
- Relay Control Module
 - see also ACM-8RF 41
- Relay options 97

- Remote Download 184
- Remote Programming 60
- Remote Station Service 56
- remote switch functions 15
- remote sync output 17
- Remote Synchronization 52
- REN
 - see also Ringer Equivalence Number 42
- Report Style 141
- Reporting Enable 133
- Reset 18, 156
- Resettable Power 19, 49
 - current 49
 - see also Smoke Detector Power 16
- Ring Count 133
- Ringer Equivalence Number 42
- S
- Secondary Phone 132
- Secondary Power Requirements 190
- Secret Code 186
- Security Features 186
- sensitivity 163, 179
 - see also smoke detector sensitivity 163
- Service Terminal 132
- Signal rate 15
- Signaling Line Circuit
 - see also SLC 16
- Silence Inhibit 15, 109, 166
- Silenceable
 - control module 88
 - NAC 106
 - waterflow 111
- Silenceable Alarm Relay 110
- silenceable circuits
 - synchronized signals 106
- Silenceable waterflow 95
- SLC 14, 19
 - current 16
 - reference manual 16
 - resistance 16
 - see also Signaling Line Circuit 14, 16
 - Style 19
 - voltage 16
 - wiring length 16
- SLC Loop Protocol 97
- SLC Style 96
- smoke detector
 - chamber reading 178
 - data 163, 178
 - sensitivity 15, 163
- Smoke Detector Power
 - current 16
- Software Zones 14, 191
- sounder 18
- Specifications 16
- strobe synchronization 15
- Style 14
- Style Y 50
 - NAC wiring 51
 - NC configuration 51
- Style Z 50
 - NAC configuration 51
 - wiring 52
- subscreen 61
- supervision
 - Phone Line 2 141
- Supervisory 161
- SUPERVISORY AR 110
- supervisory relay
 - configuring for 4XTMF 57
- sync
 - programming 105
 - see also synchronization 109
- sync output 17
 - current 17
 - End-of-Line resistor 17
 - voltage 17
- synchronization 52, 164, 173
 - by manufacturer 109
 - programming 109
 - see also strobe synchronization 15
- synchronized 164
- synchronized signals 164
 - and silenceable circuits 106
- System
 - Maintenance Level 153
- System Point 169
- system power 14
- System Setup 97
- T
- Telephone Circuitry 42
- Telephone Company
 - Rights and Warnings 43
- telephone line 54
- Terminal 133
- Test Time Interval 136, 137
- Time and Date
 - Maintenance Level 153

- Time setting 100
- Time-Date setting 97, 100
- Time-out 186
- Timers 97
- Transformer Assembly 20
- Transmittal Priorities 182
- Transmitter Module 56
 - see also 4XTMF module 21
- Trouble 158
- trouble display 159
- trouble relay 14
- Trouble Reminder 97, 166, 172
- trouble responses 159
- Two Stage 93, 155
- two stage operation 108
- Type
 - control module 87
 - detector 69
 - monitor module 79
 - NAC 106
- type code
 - control module 87
 - supervision 163
 - verification 15
- U
- UL power-limited wiring requirements 53
 - see also power-limited and nonpower-limited 50
- Upload/Download 184
- V
- Verification
 - detector 69
- Verify Loops 111
- View Events 112
- voltage
 - measurements 171
 - ranges 171
- W
- Walktest 15, 69, 88, 113
 - audible 113
 - Maintenance Level 151
 - operation 167
 - selection 81
 - silent 113
- waterflow
 - nonsilenceable 95, 111
 - silenceable 95, 111
- Waterflow Delay timer 102, 103
- Waterflow Retard Timer 166
- Waterflow Silenceable 97
- Wire Requirements 205
- wiring
 - AC Power 49
 - earth ground 49
 - NAC Style Y 51
 - NAC Style Z 52
- wiring Style 14
- X
- XRM-24
 - see Transformer
- Z
- Z00 71, 81
- Z97
 - PAS zone 70
- Z98 71
- Zone 97 93
- Zone 98 93
- Zone Assignment 71, 81, 109
 - control module 88
- Zone Setup 92
 - Maintenance Level 154
- zone type 95
 - list 95
- Zone Z97 70
- Zone Z98
 - pre-signal zone 71
- Zones 170, 191
 - see also software zones 14
- Zones Disabled 94
- Zones Enabled 94
- Zones Installed 94
- zones per device 71

Notes

Notes

Notes

Limited Warranty

Honeywell International Inc. warrants products manufactured by it to be free from defects in materials and workmanship for eighteen (18) months from the date of manufacture, under normal use and service. Products are date stamped at time of manufacture. The sole and exclusive obligation of **Honeywell International Inc.** is to repair or replace, at its option, free of charge for parts and labor, any part that is defective in materials or workmanship under normal use and service. All returns for credit are subject to inspection and testing at the factory before actual determination is made to allow credit. **Honeywell International Inc.** does not warrant products not manufactured by it, but assigns to the purchaser any warranty extended by the manufacturer of such products. This warranty is void if the product is altered or repaired by anyone other than **Honeywell International Inc.** or as expressly authorized by **Honeywell International Inc.** in writing, or is serviced by anyone other than **Honeywell International Inc.** or its authorized distributors. This warranty is also void if there is a failure to maintain the products and systems in which they operate in a proper and workable manner. In case of defect, secure a Return Material Authorization form from our Return Authorization Department.

This writing constitutes the only warranty made by **Honeywell International Inc.**, with respect to its products. **Honeywell International Inc.**, does not represent that its products will prevent any loss by fire or otherwise, or that its products will in all cases provide the protection for which they are installed or intended. Buyer acknowledges that **Honeywell International Inc.**, is not an insurer and assumes no risk for loss or damages or the cost of any inconvenience, transportation damage, misuse, abuse, accident or similar incident.

HONEYWELL INTERNATIONAL INC. GIVES NO WARRANTY, EXPRESS OR IMPLIED, OF MERCHANTABILITY, FITNESS FOR ANY PARTICULAR PURPOSE, OR OTHERWISE WHICH EXTENDS BEYOND THE DESCRIPTION ON THE FACE HEREOF. UNDER NO CIRCUMSTANCES SHALL **HONEYWELL INTERNATIONAL INC.** BE LIABLE FOR ANY LOSS OF OR DAMAGE TO PROPERTY, DIRECT, INCIDENTAL OR CONSEQUENTIAL, ARISING OUT OF THE USE OF, OR INABILITY TO USE **HONEYWELL INTERNATIONAL INC.'S** PRODUCTS. FURTHERMORE, **HONEYWELL INTERNATIONAL INC.** SHALL NOT BE LIABLE FOR ANY PERSONAL INJURY OR DEATH WHICH MAY ARISE IN THE COURSE OF, OR AS A RESULT OF, PERSONAL, COMMERCIAL OR INDUSTRIAL USE OF ITS PRODUCTS.

This warranty replaces all previous warranties and is the only warranty made by **Honeywell International Inc.** No increase or alteration, written or verbal, of the obligation of this warranty is authorized.



World Headquarters
1 Firelite Place
Northford, CT 06472-1653 USA
203-484-7161
fax 203-484-7118

www.firelite.com

ISO 9001
CERTIFIED
ENGINEERING & MANUFACTURING
QUALITY SYSTEMS